

Q-Sense E4 Operator Manual

Including the acquisition software QSoft 401



The Q-Sense E4 System:

- QE 401 Electronics Unit
- QCP 401 Chamber Platform
- QFM 401 Flow Module
- and accessories

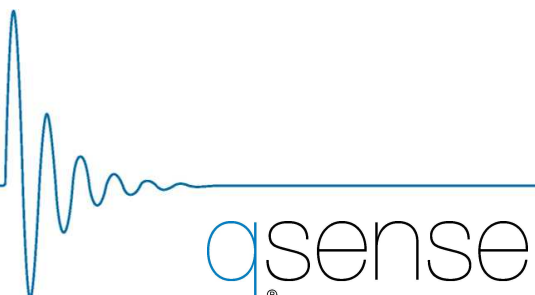

Q-Sense E-Series

All rights reserved. No parts of this work may be reproduced in any form or by any means - graphic, electronic, or mechanical, including photocopying, recording, taping, or information storage and retrieval systems - without the written permission of the publisher.

Products that are referred to in this document may be either trademarks and/or registered trademarks of the respective owners. The publisher and the author make no claim to these trademarks.

While every precaution has been taken in the preparation of this document, the publisher and the author assume no responsibility for errors or omissions, or for damages resulting from the use of information contained in this document or from the use of programs and source code that may accompany it. In no event shall the publisher and the author be liable for any loss of profit or any other commercial damage caused or alleged to have been caused directly or indirectly by this document.

The information in this document may be changed without notice. The only warranties for the products and services are the ones stated in the associated purchase agreements. Nothing in this manual should be interpreted as a further warranty.

© 2009 Q-Sense AB

Publisher Q-Sense AB, Sweden

Editor Hans Uddenberg

Edition AG, 2009-09-09

Table of Contents

Chapter 1	Introduction	5
1.1	Features of the E4 system	5
1.2	Conventions	5
	Acronyms and Abbreviations	5
	Warnings, Cautions and Notes	6
Chapter 2	Safety	7
2.1	Safety precautions	7
	General Safety	7
	Measurement Chamber and Flow Modules	8
	Peripheral Equipment	8
Chapter 3	Q-Sense System Overview: Components	9
Chapter 4	Installation	10
4.1	Transportation and Storage	10
4.2	Unpacking and Inspection	10
4.3	Installing Software	10
4.4	Installing Hardware	10
	Environmental Aspects	10
	Connecting the E4 Parts	10
4.5	Verification of Installation	12
4.6	Cleaning	14
Chapter 5	Operation	15
5.1	Measurement Procedure - Overview	15
5.2	Preparation of Sensor Surfaces	16
	The Q-Sense Sensor Crystal	16
	Handling Sensor Crystals	16
	Preparation of Surfaces	17
5.3	Preparation of Sample Liquids	19
5.4	Set-up of Measurement	20
	The Flow Module	20
	Mounting the Sensor Crystal	22
	Connecting the Tubing	23
	The E4 Chamber Platform Set-Up	24
	Working with the Flow Module	25
5.5	Running a Measurement	26
	Verifying System Performance	27
5.6	After Measurement	27
5.7	Q-Sense Electrochemistry Module (Optional)	29
5.8	Q-Sense Window Module (Optional)	29
	Assembling the Window Module	30
	Cleaning the Window Module	30

5.9	Q-Sense Ellipsometry Module (Optional).....	31
	Using the Ellipsometry Module	31
	Assembling the Ellipsometry Module	31
	Cleaning the Ellipsometry Module	34
5.10	Q-Sense Humidity Module (Optional)	34
	Tabled Relative Humidity for Salts	35
5.11	Q-Sense Open Module (Optional)	35
Chapter 6	QSoft 401	36
6.1	Main Window.....	36
6.2	Setup Measurement.....	36
	Find Resonances	37
	Temperature Programming	39
6.3	Measurement Windows.....	41
6.4	Terminating a Measurement.....	43
6.5	Condense a measurement.....	43
6.6	Stitch data files.....	44
Chapter 7	Your First Measurement	46
Chapter 8	Troubleshooting	48
8.1	Prior to Measurement.....	48
8.2	When Starting a Measurement.....	48
8.3	During a Measurement.....	49
8.4	After a Measurement.....	52
Chapter 9	Consumables & Accessories	54
Chapter 10	Materials Guide	55
Chapter 11	Support and Service	56
Chapter 12	Technical Specifications E4	57
	Index	58

1 Introduction

This manual describes how to install and use your Q-Sense E4 system to make QCM-D measurements for real-time studies of surface or surface-bound processes such as adsorption, interactions and changes of mass and mechanical properties in ultra-thin films. The instrument is the second generation of Q-Sense instruments based on the patented QCM-D technique, and constitutes a complete turnkey system including everything needed to quickly get started and produce high quality data.

Information on the principles of the QCM-D technique, and interpretation of measurement data is not included in this operator manual.

To quickly get started, go directly to the Chapter "Measurement Procedure - Overview".

Any comments or suggestions to changes of this manual are very welcome, please contact us at support@q-sense.com.

1.1 Features of the E4 system

- Tracking mass changes: molecular layers forming on the sensor surfaces are sensed at the nanogram level.
- Viscoelastic properties: structural changes in the adsorbed layers are monitored simultaneously, through the *D*-factor reading.
- Real-time presentation of data: what happens on the surfaces, evaluation of kinetics, etc, is displayed using QSoft 401 software.
- Label free: there is no need for labeling of molecules.
- Flexible choice of surfaces: any surface that can be applied as a thin film can be used, such as metals, polymers and chemically modified surfaces.
- Flow measurements: the Q-Sense flow modules are specifically designed for flow measurements in a temperature-controlled environment.
- 4-Sensor chamber: the 4 flow modules can be either connected in a series mode, or run parallel.
- Build-on options for combination measurements: Combine with simultaneous electrochemistry, ellipsometry, microscopy and more (additional hardware necessary).
- Easy cleaning: all parts exposed to liquid can be removed and immersed in cleaning baths.

1.2 Conventions

The following conventions are applied throughout the manual.

Acronyms and Abbreviations

The first time an abbreviation appears in the manual, the expanded form is shown, followed by the abbreviation in parenthesis, e.g. Dissipation (*D*). The abbreviated form is shown without parenthesis when the expanded form is not used. Below is a list of the acronyms/abbreviations and their expanded form used in this manual.

Short version

QCM-D

 f D

crystal

flow module

Meaning

Quartz Crystal Microbalance with Dissipation Monitoring

Frequency

Dissipation

Q-Sense sensor crystal

The removable sensor housing on the chamber platform

Warnings, Cautions and Notes

**WARNING!**

Statements identify conditions or practices that could result in personal injury or loss of life.

CAUTION!

Statements identify conditions or practices that could result in damage to equipment or other property.

Note!

Notes emphasize important points.

2 Safety

In no event shall Q-Sense AB ever be held responsible or liable for any direct, indirect, incidental, special or consequential damages or costs whatsoever resulting from or related to the use or misuse of the Q-Sense E4 instrument or components thereof, even if Q-Sense AB has been advised, knows of, or should be aware of the possibility of such damages. Q-Sense AB emphasizes the importance of consulting experienced and qualified professionals to assure the best results when using the Q-Sense E4 or E1 instrument.

2.1 Safety precautions

WARNING!



The safety requirements listed in this manual must be followed in order to avoid personal injury and damage to the Q-Sense instruments.

General Safety



WARNING!

- **RISK OF ELECTRICAL SHOCK.** Do not connect this instrument to electrical power if the enclosure is damaged or any of the covers or panels are removed. Make sure the voltage rating on the instrumentation matches the line voltage available in the lab. Connect only to outlets with safety earth ground. Make sure that the power cord is easily accessible when the equipment has been installed.



WARNING!

- **RISK OF ELECTRICAL SHOCK OR FIRE HAZARD.** Switches may produce electrical sparks. Do not use the Q-Sense instruments in the presence of flammable gases, fumes or liquids.
- The instrument has been designed for indoor use only. Do not expose it to rain, snow or dust. During storage or transport the instrument should be kept dry. Temperatures below 0°C and above 50°C should be avoided. Do not operate at ambient temperatures below 5°C and above 30°C.

CAUTION!

- Use only as specified in the operating instructions. Follow all instructions. Skipping steps can result in damage to the Q-Sense instrument.
- Handle carefully when removing the instrument from the transport packaging. The product must always be shipped in either the original packaging supplied by Q-Sense, or equivalent.

CAUTION!

- Do not use force when connecting or disconnecting connectors as damage may occur.
- Do not subject the equipment to external shocks.

- Do not block or restrict ventilation slots.
- Do not expose any parts other than the sample volume in the flow module(s) to water or other liquids.

CAUTION!

- If liquid is spilled on the instrument, disconnect it from the power source and have it checked by an authorized person.
- When handling chemicals, refer to the safety information from the supplier and general safety regulations in your country.
- Carry out appropriate decontamination if equipment is exposed to hazardous material.
- Do not install substitute parts or perform any unauthorized modification to the product. Return the product to Q-Sense or other qualified and authorized personnel for service and repair to ensure that safety features are maintained. Before returning the instrument it must be free of hazardous contamination.

Measurement Chamber and Flow Modules

This refers to all measurement chambers provided by Q-Sense and described in this manual, e.g. the Q-Sense Chamber Platforms (QCP 401, and QCP 101), the Q-Sense Flow Module (QFM 401), and the Electrochemistry Module (QEC 401).

**WARNING!**

- **RISK OF FIRE HAZARD.** Use only sample liquids with a self ignition point higher than 85°C in the sample volume of the flow modules.
- Parts of the measurement chamber and flow modules can become hot.
- Do not expose any parts other than the sample volume to water and other liquids.
- If liquid is spilled inside the electronics part of the Chamber Platform, disconnect it from the electronics unit and have it checked by an authorized person.

Peripheral Equipment

This refers to all equipment except the Chamber Platform, the Flow Module(s) and the Electronics Unit.

- For safety instructions and operation of peripheral equipment, e.g. the personal computer, read the safety instructions and the manual provided by the manufacturer carefully.
- Make sure that all instruments are connected to a power supply with safety earth ground.
- Only personal computers certified to conform to the IEC 60950 standard may be used with this system.

3 Q-Sense System Overview: Components

The complete Q-Sense E4 system consists of the following main parts:

1. Sensor Crystal

The sensing element itself. The measurement surface of the standard sensor crystal is gold, but the top layer can be almost any other material.

2. Flow Module

Holds one sensor crystal. The flow module is part of the temperature controlled environment, allowing the measurement liquid to stabilize at the desired temperature in a snake-shaped path before reaching the sensor surface. The module can easily be separated from the chamber platform, and disassembled for cleaning.

3. Chamber Platform

The base for the flow module(s). The platform holds four flow modules, which can be connected in any desired configuration - serial or parallel - depending on how the tubing is arranged. With the window lid closed, the chamber constitutes a controlled temperature environment, with a heating and cooling thermoelectric device beneath the flow module row.

4. Electronics Unit

Where the signals are generated and data is collected before being sent to the computer. Holds the temperature-compensated reference crystal from which all signals originate, as well as the temperature control system for the thermoelectric device in the chamber platform.

5. Acquisition software QSoft 401

Easy-to-use, Windows-based software for simultaneously acquiring and displaying QCM-D measurements simultaneously from the 4 sensors..

6. Analyzing software QTools

A powerful tool to extract mechanical properties of the measured system, such as viscosity and elasticity, and to design diagrams and figures for data presentation exactly as you like it.

7. External pump

The E4 system requires a sample feeder, which is a peristaltic pump in the standard delivery.

8. Electrochemistry Module (optional)

Enables simultaneous electrochemical measurements on the QCM-D surface (used as the working electrode). The potentiostat and software, etc. needed for a complete electrochemical set-up are not included. The cell is mounted on the chamber platform.

9. Window Module (optional)

Enables simultaneous microscopic studies of a QCM-D surface if used together with the E1 platform, as well as studies of light-induced reactions. Docks to the chamber platform as a standard flow module.

10. Ellipsometry Module (optional)

Enables simultaneous ellipsometry and QCM-D measurements on the same sensor surface. The ellipsometry light source is not included with Q-Sense equipment.

11. Humidity Module (optional)

Enables studies of vapor uptake into films. The module contains a GORE™ membrane through which water vapor is led over the sensor surface, from the flow path above.

12. Open Module (optional)

The Open Module is designed to enable pipetting of samples directly to the sensor surface in order to minimize sample size.

4 Installation

4.1 Transportation and Storage

CAUTION!

To avoid damage, Q-Sense equipment should always be transported in its original packaging. The equipment must be stored in a normal indoor environment.

4.2 Unpacking and Inspection

The Q-Sense E4 instrument system is a high precision piece of equipment and should be handled with care. Upon delivery, check immediately for damage to the product or packaging material. In case of damage, contact Q-Sense or your local provider before further installation (see Chapter "Support and Service").

4.3 Installing Software

NOTE: It is important to install the software PRIOR to connecting the instrument to the PC.

The reason for this is that the required USB drivers necessary for proper communication between electronics unit and PC have to be present when Windows for the first time detects that a new hardware has been connected to the PC. If Windows fails to find valid drivers it will put the USB device in an error state. To remove this error state it is necessary to uninstall it which is done in the 'Window's' Device Manager.

QSoft401 is only supported on Microsoft's Windows XP and Vista platforms. Also note that QSoft401 requires that the PC has a USB 2.0 port in order to acquire data.

To install the software, just click the "QSoft401 2.X.X Installer.exe" file you either downloaded or have on your installation CD. Then follow the instructions.

You also need to be able to run as administrator on the PC in order to fully install the software.

The latest software can also be found on Q-Sense website www.q-sense.com, under the user pages. Make sure you have your customer log-in and password available.

4.4 Installing Hardware

Environmental Aspects

- The Q-Sense E4 system is intended for indoor operation in a laboratory environment.
- The equipment should be placed on a stable bench. Reserve at least 90 x 80 cm of space with free air circulation above and at all sides of the electronics unit.
- It is not recommended to place the instrument directly beneath an air conditioner.
- Direct sunshine on the instrument should be avoided.

Connecting the E4 Parts

Before making any connections, make sure that both the computer and electronics unit are turned off.

1. For installation of the PC, see the manufacturer's manual.
2. Connect the USB cable to the USB port on the back of the electronics unit and to the port on the PC.

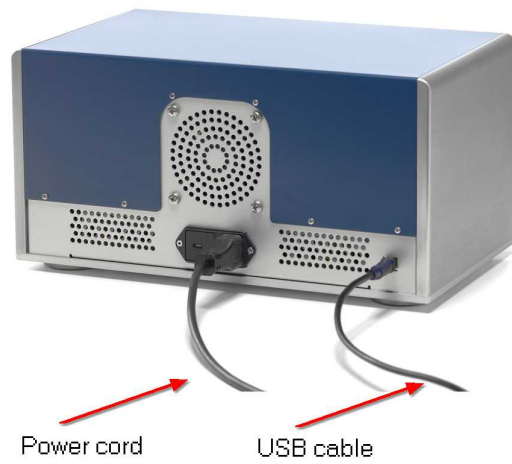

3. Connect the three cables of the chamber platform to the sockets on the front of the electronics unit. Note that each cable fits to only one socket:



Two of the cables have the same electrode pin set-up, but different tabs on the casing;

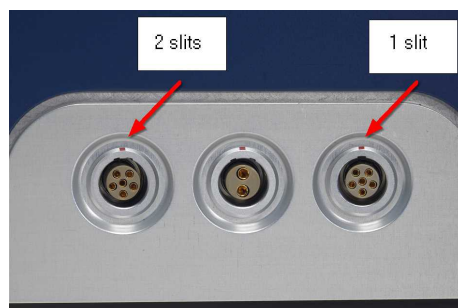

Each cable fits to its own socket on the electronics unit.



Connecting the chamber platform to the electronics unit.



WARNING!

Make sure that the voltage rating on the electronics unit matches the line voltage available in the lab. Connect only to grounded outlets. When connected, make sure that the power cord is easily accessible.

4. Connect the power cord to the power socket on the electronics unit's back panel (see above) and plug it into a grounded outlet.

Note!

Do not turn on the instrument until the software has been installed on the computer. Otherwise the computer will not be able to identify the new hardware.

4.5 Verification of Installation

When the software has been installed, and the instrument has been connected, turn on the electronics unit by pressing the power button. If successful, the green lamp around the power button will be illuminated.



The instrument will be announced as "New hardware found" the first time it is connected via the USB 2.0 to the computer. A wizard will guide through the installation of the hardware ("Q-Sense E-Series Device") before any measurements can be conducted. Here is a list of the screens that will follow during such a procedure on a Windows XP PC (installing on Vista is very similar but you will have to give your consent in few more message dialogs).



Skip Windows Update Search, and browse for the QSoft 401 folder under Program Files\Q-Sense to locate the installation files:

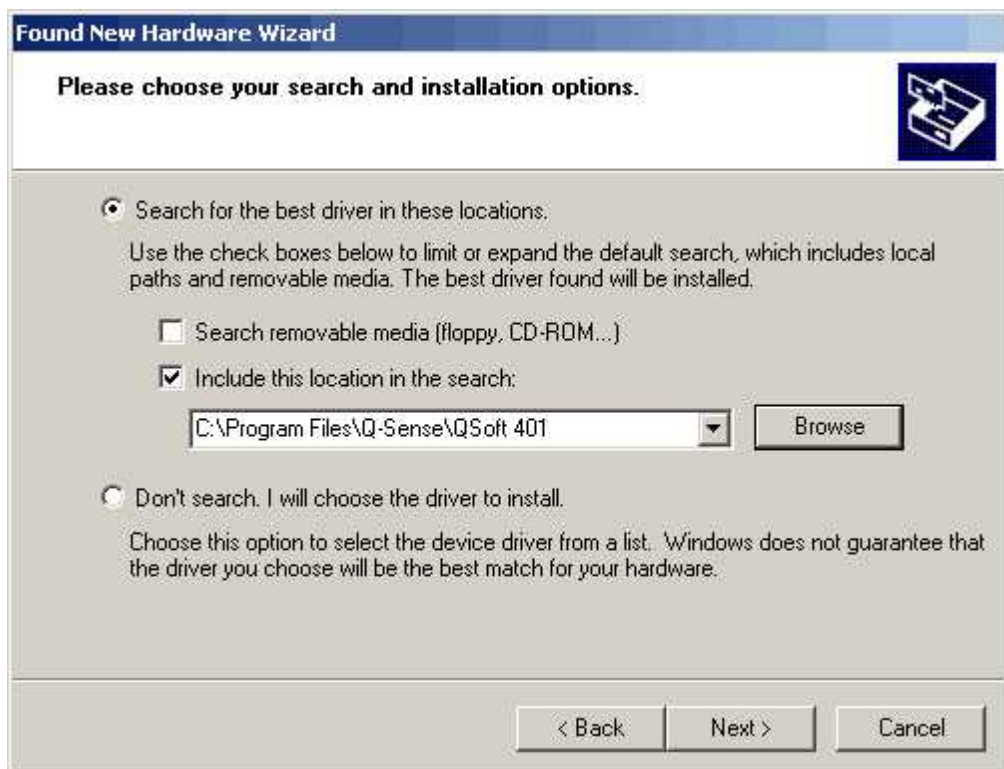

Note!

Windows will not recognize the software - choose "Continue Anyway" when asked about stopping installation.

Verify the installation by starting QSoft401.exe, which is located in the folder C:\Program files\Q-Sense\QSoft 401 unless another folder was chosen during software installation. A correct installation of the instrument and of the software will allow the temperature control to be turned on, which is found at the lower left corner of the main window:

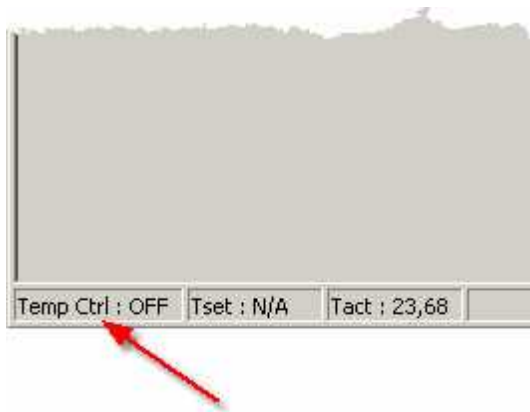

Turn on the temperature control by clicking on the Temp Ctrl panel.

4.6 Cleaning

The electronics unit and the cover of the chamber platform can be cleaned with a damp cloth. Ensure that the surfaces are dried immediately after cleaning.

For cleaning of the flow modules and its surfaces exposed to sample fluids, see Chapter "Operation".

For cleaning of the PC, see the manufacturer's manual.

5 Operation

5.1 Measurement Procedure - Overview

The flow chart below lists the necessary steps for a successful QCM-D measurement. All steps are described in detail in this chapter, found under their respective flow chart symbols.



Preparation of sensor surfaces

- Cleaning
- Functionalization
- Crystal load

Preparation of sample liquids

- Degassing
- Temperature stability
- Solution properties

Set-up of measurement

- Connecting the tubing
- Mounting the crystal in the flow module

Running a measurement

- Checking the chemical compatibility
- Measurement procedure

After measurement

- Cleaning

5.2 Preparation of Sensor Surfaces

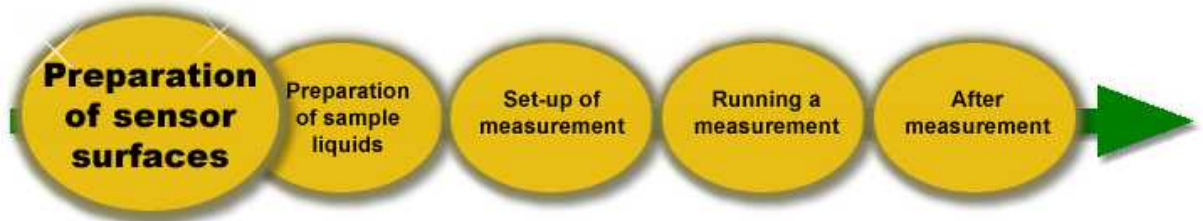

The Q-Sense Sensor Crystal

The figures below show a standard gold-coated sensor crystal. It consists of:

- A quartz disk
- Electrodes sputtered on both sides of the quartz disc, consisting of a gold surface layer with a chromium under layer to strengthen the adhesion.

When inserted in a flow module, it is the active side that will be in contact with the sample during measurement (see figure). The counter electrode and electrical contacts for the electrodes are on the backside (contact side) of the crystal, and are not in contact with the sample solution.

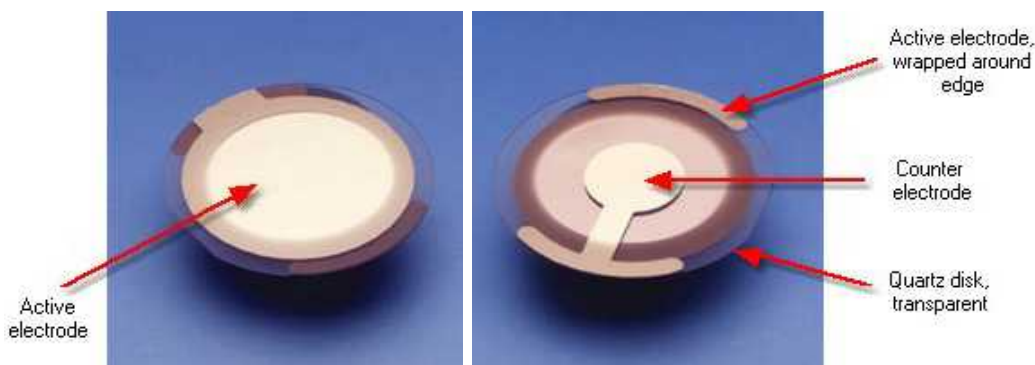

Handling Sensor Crystals

- Keep the crystals in a clean environment. When not in use store them in their original box.
- Avoid scratching the center part of the crystal.
- Always rinse with purified water or another appropriate pure liquid before drying the crystal.
- Always use a flow of dry, oil-free, non-reactive gas (e.g., nitrogen) to blow-dry the crystal. Liquid should be chased off the crystal rather than being evaporated on it.
- Hold the sensor crystal with a pair of tweezers. Using bare fingers will contaminate the crystal. Hold it on the outer edge outside the electrode area to prevent scratches, as shown below. The tweezers should have a round end and smooth gripping surfaces.



Preparation of Surfaces

Note!

The surface properties of the sensor crystal are crucial for the interaction of sample material with the surface. Therefore, the use of proper procedures for cleaning and surface preparation are required to obtain reproducible measurements.

Cleaning

The most appropriate cleaning method depends on the sample system, the interaction of the sample with the crystal surface, and the properties of the sensor crystal itself.

Please refer to Q-Sense document *Cleaning & Immobilization Protocols* for a description of the recommended cleaning protocols of sensor surfaces.

To avoid re-contamination while rinsing and drying the sensor crystal, please observe the following instructions:



1. Rinse the crystal with purified water or another appropriate pure liquid.

Note!

Hold the crystal with a pair of tweezers from underneath to prevent washing contaminants from the tweezers onto the crystal.

2. Chase liquid off the crystal with a flow of nitrogen gas.

Note!

Liquid remaining on the edge of the crystal can be wicked off with a clean, lint-free tissue.

For best protection of the sensor crystals, use the Q-Sense crystal cleaning Teflon holder (QCLH 301), while working with them. The Teflon holder holds the crystals in a stable position, preventing scratching and touching.

Surface modification

The sensor crystal can be coated with almost any material as long as this can be applied in a sufficiently thin and well attached layer. The surface can be custom modified by evaporation, spin-coating, or chemical treatment. For recommendation of spin-coaters, please contact your local Q-Sense supplier.

For functionalization of surfaces, like NTA/Ni complex, lipid bilayer-Biotin-Streptavidin etc, Q-Sense has protocols available.

Load

The thickness of applied films may vary from a few Ångström to a few micrometers. The maximum layer thickness depends on the viscoelastic properties of the applied material. Basically the crystal load is limited by two factors: total damping or lost sensitivity.

For highly viscous or solid materials, the damping of the crystal will increase with increasing layer

thickness. At a certain thickness (usually a couple of micrometers) the damping becomes too high and the crystal cannot be driven anymore, i.e. the measurement fails.

Other more elastic materials will not couple completely to the crystal's oscillation. With increasing layer thickness, the outermost parts of the attached layer coupling will weaken and at a certain thickness (usually a few micrometers) the coupling will be lost completely. In this case, a measurement can still be performed but the equipment will only sense the part of the layer in the vicinity of the crystal.

Reuse and consumption

The sensor crystal can under favorable conditions be reused 10-30 times. However, this requires careful handling and cleaning procedures that do not harm the crystal or its coating.

Traces of consumption and wear can often be seen visually. Edges of the sensor crystal might become cracked and the coating start to show scratches and holes. When the crystal is close to being worn out, the measurement signal will become noisy, possibly even shaky. It might even be difficult to obtain a stable baseline.

5-3 Preparation of Sample Liquids

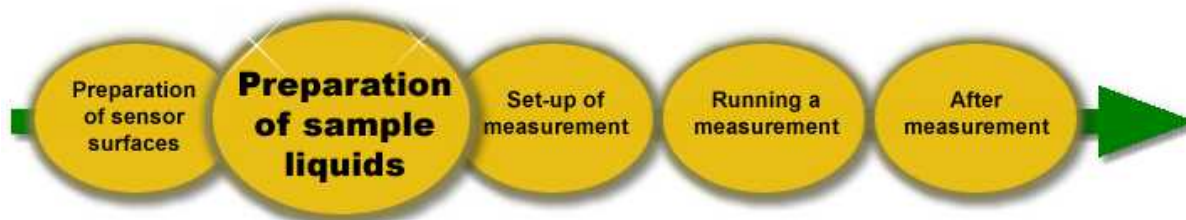

To minimize distortion of measurements in the liquid phase, the sample liquid should be prepared carefully. Changes in temperature or the properties of the solvent as well as air bubbles will affect the sensor signal. For reproducible measurements, keep the following in mind:

Degassing the Sample Liquid

The sample liquid should be degassed (e.g., in a sonicator bath) prior to measurement to reduce the risk for formation of air bubbles in the measurement system.

Temperature of the Sample Liquid

To avoid the formation of air bubbles and reduce temperature related artifacts the sample liquid should have approximately the same temperature as the measurement chamber's working temperature (± 2 °C). Keeping the temperature in the chamber slightly *lower* than the sample liquid container outside will also reduce the risk for bubbles falling out from the liquid.

Solution Properties

The QCM-D technique is sensitive to changes also in the bulk solution over the applied films. To avoid unwanted effects in the signals due to changes in the properties of the buffer liquid (or solvent), solutions should be prepared carefully. Two rules of thumb:

- Preferably use purified samples at high concentration and dilute them in the appropriate buffer (or solvent) just before measurement.
- Use solvents or buffers from the same stock during one measurement.

5.4 Set-up of Measurement



The typical set-up is continuous flow mode, where the sample fluids are rinsed over the surface(s) successively, using an external pump. By stopping the pump after each sample rinse, a controlled batch mode can be applied (stop-flow mode).

Note!

Please observe the following points before preparing the chamber and flow modules for measurements:

- Always rinse with purified water or another appropriate pure liquid (e.g., alcohol) before drying the parts of the chamber/flow module.
- Always use a gas flow of nitrogen or another non-reactive gas when blow-drying any part of the chamber/flow module.
- Use only soft, lint-free tissue when drying and cleaning parts of the chamber/flow module.
- Use a pair of tweezers to hold the o-ring. Using bare fingers will contaminate the o-ring.
- Hold the sensor crystal with a pair of tweezers. Using bare fingers will contaminate the crystal. Hold it on the outer edge outside the electrode (as shown in Chapter "Handling Sensor Crystals"). The tweezers should have a round end and smooth gripping surfaces.

The Flow Module

The Flow Module is the core of all measurements system. It is carefully designed for measurements:

- Where solvents/buffers have to be exchanged;
- In flowing liquid or gas;
- Of adsorption and desorption of molecules/particles from solution (proteins, lipids, surfactants, polyelectrolytes, etc.);
- In flowing gas with varying humidity.

With the Electrochemistry Module mounted, the same measurements can be expanded with electrochemical parameters; with the Window Module mounted, optical monitoring or light-induced reactions is enabled; with the Ellipsometry Module mounted, simultaneous ellipsometry parameters can be added.

As it is completely separated from the rest of the instrument, different flow modules can be kept separated for different types of experiments, as well as for different users.

Function of the flow module

There is an inlet and an outlet on the flow module, denoted with arrows. To ensure optimum temperature stability during a measurement, the sample liquid should be flown in this direction:



Arrows on top of the module denote the flow direction.

When liquid flows through the inlet, it passes a snake-shaped path, where it stabilizes at the set temperature, before entering the chamber void where the sensor surface is. After the sensor, it is rinsed directly to the outlet. The whole module is heated/cooled to the set temperature of the chamber platform, when it is locked in position on the chamber platform.

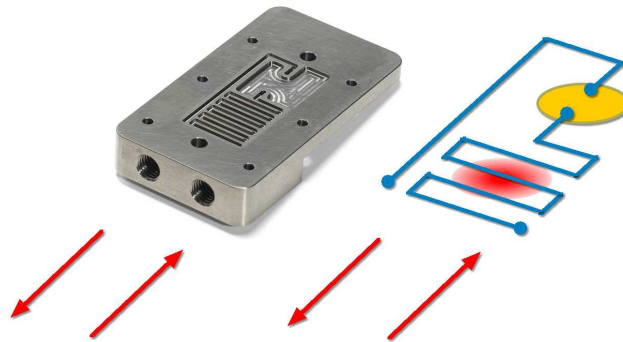

Interior of flow module: flow of sample solution.

All parts of the module that are exposed to sample liquid can be taken apart for cleaning - see sub Chapter "After Measurement". **Note however that the contact block with its electrode pins should not be taken apart or immersed in any cleaning solution!**

Mounting the Sensor Crystal



1. Unscrew the flow module. For stability, the flow module can be placed in its holder while unscrewing.

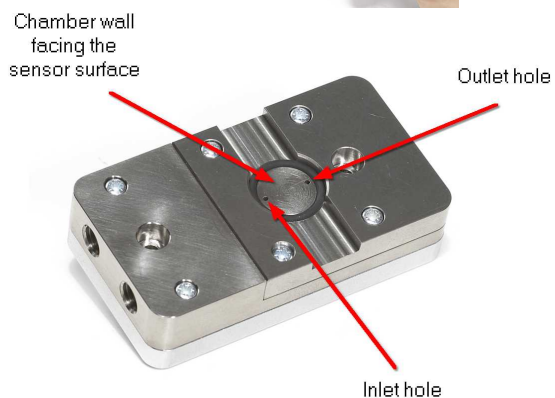

2. The inlet and outlet to the chamber void will then be visible, inside the o-ring.

Important! Make sure that the o-ring is lying flat in its bed.



3. Place the sensor crystal with its active side down, resting on the o-ring. The arrow-shaped electrode should then point as shown to the left (also indicated on the module).



4. A correctly mounted sensor crystal, with its backside upwards and the active side towards the flow system.

Check that the crystal is lying parallel to the lowering of the housing, and as centered as possible.

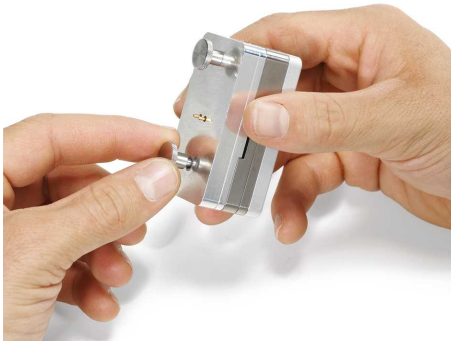

5. Screw the contact block back onto the flow module.

Connecting the Tubing

The connectors for flow set-up on the modules are made of HPLC standard components, provided in the Liquid Handling Set. They are mounted as follows:

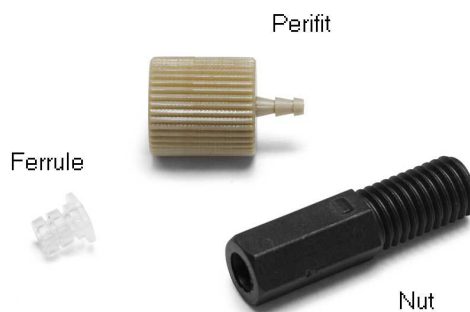

1. To connect the tubing to the flow module, you need a nut and a ferrule. For connection to the peristaltic pump, you also need a perifit.



2. Slip the nut over the Teflon tube, with the threads towards the end of the tube. Then, slip the ferrule over the tube, with its largest diameter towards the end.



3. Screw the nut onto the flow module. The ferrule will press against the tubing and seal the connection.

Connecting the tubing to the pump

The perfitt connects Teflon tubing with flexible pump tubing.



To connect to the standard tubing delivered with the pump, use the perfitt together with the nut and ferrule.

The E4 Chamber Platform Set-Up



Complete set-up including an optional sample heater, with samples pumped from heat block at the right, via the measurement chamber to the waste container at the left.

The standard set-up of an experiment is to draw the samples through the system, from the sample containers (optionally, in a sample heat block, if measuring at temperatures far above ambient temperature), through the system, having the pump after the flow modules. By having the pump connected *after* the measurement chamber in the flow system, leakages and liquid spills are avoided, and contamination of pump tubing is less critical.

The E4 Chamber Platform holds 4 flow modules. They can be set up in any combination - all four serially, all four parallel, one module alone, etc, depending on how they are interconnected by the tubing. The software will run one to four independent measurements, regardless of their order.



Four flow modules, set up in parallel.

1 2 3 4

Order of sensors, used in the software.

Working with the Flow Module



1. Place the flow module with the spring-loaded electrode pins pointing downwards...



2. ...so that they contact the plates on the heat block of the chamber platform.

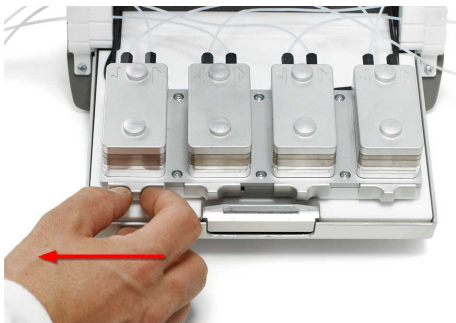

3. Close the latch.



4. Line the tubing in the Teflon slits on the sides of the chamber.



5. Close the lid.



6. Between measurements, rotate the flow module upside down for stable handling during crystal loading etc.

5.5 Running a Measurement

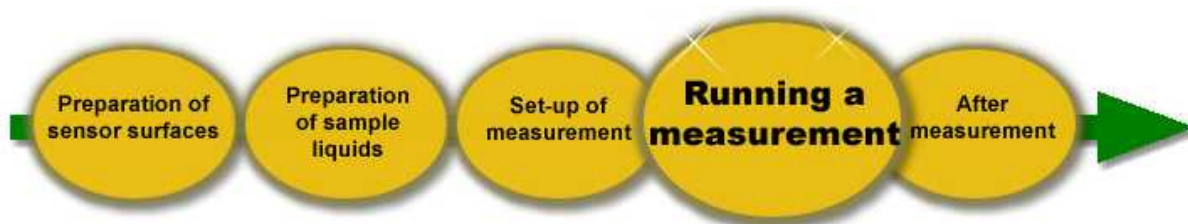

CAUTION!

Before starting an experiment, ensure that the sample fluid is chemically compatible with the measurement chamber and the sensor crystal.

The standard parts of the chamber exposed to the sample consist of the following materials:

- Chamber walls: Titanium, grade 2
- Temperature stabilizing loop: Viton® rubber
- O-ring: Viton® rubber
- Tubing: Teflon®

A short table of chemical compatibility data can be found in Chapter "Materials Guide".

Measurement procedure

Step 1. Connect pump and tubing to the flow modules.

Step 2. Make sure that the chamber platform is connected to the electronics unit, that the electronics unit is properly connected to the computer, and that QSoft software is started (see Chapter "Installation").

Step 3. Mount a sensor crystal in the flow module and place it on the heat block on the chamber platform (see sub Chapter "Mounting the Sensor Crystal").

Step 4. Activate the temperature control (see Chapter: "QSoft 401"). Adjust the temperature setpoint to desired value and wait 5-10 minutes for equilibration (longer time may be needed if the set temperature differs greatly from room temperature).

Step 5. Run the pump, and fill the flow modules with buffer solution.

Step 6. Start data acquisition (see Chapter: QSoft 401").

Step 7. (If continuous flow mode is used, stop the pump temporarily) Switch the tube to the sample container, and start the pump again to fill the chamber with the next fluid, all while the data acquisition is running. Make sure that no air bubbles are introduced to the system while changing fluids. Continue to change sample fluids, until your experiment is finished.

Note!

For optimal measurements:

- The sample liquid temperature should be within $\pm 2^\circ\text{C}$ compared to the set temperature in the chamber. Having the inside chamber temperature slightly below the outside sample temperature will reduce the risk for bubble formation.
- The rinsing speed should not exceed 1 ml/min to allow the sample liquid enough time for temperature stabilization in the flow module before reaching the sensor surface.

Verifying System Performance

When the crystal is correctly mounted, the flow module is bubble free, and the temperature inside the flow module is stable, the system shall show the following performance with a new crystal inserted:

- The baseline for f and D should be stable. For example, a clean non-coated standard Au crystal in water should not drift more than 2 Hz/hour and 0.2×10^{-6} respectively. In air, the drifts are usually larger, due to slower changes in e.g. humidity.
- The noise levels should be lower than 0.6 Hz (peak-to-peak) and 0.15×10^{-6} (peak-to-peak) respectively, when measured within a period of 2 minutes.
- The absolute f value of the fundamental resonance tone should be in the interval 4,900 - 5,000 kHz.

If any deviations from the values above are experienced, please check Chapter "Troubleshooting".

5.6 After Measurement

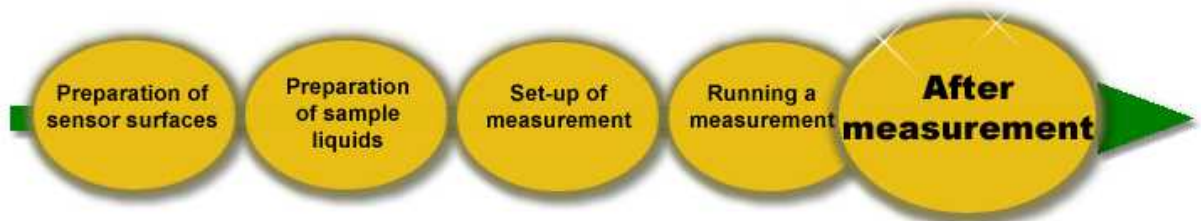

Adequate cleaning procedures for the flow modules are required for stable and reproducible measurements. Cleaning the flow module immediately after each measurement is recommended. Depending on your needs, choose either the minimum one or the extensive cleaning. Usually, the extensive cleaning is only needed between different experiment setups. For further cleaning protocols, please refer to the "Cleaning and Immobilization protocols" pdf document [at our website](#).

Minimum cleaning after each measurement:

1. Rinse thoroughly with the buffer used OR milli-Q water, before removing the sensor crystal.



2. Dry the visible parts of the flow module interior, where the sensor crystal is placed.

3. Insert a fresh sensor crystal.

Recommended extensive cleaning procedure:

1. To clean the Teflon tubings, rinse the system thoroughly with either an appropriate cleaning agent or pure water, depending on which sample fluids that has been used.



2. Remove the tubing from the flow modules, by unscrewing the HPLC nuts.



3. Open the flow module with the finger screws, and remove the crystal.



4. Unscrew the Titanium flow part.

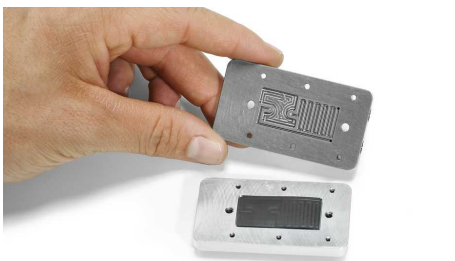

5. The temperature loop will now be visible, with its sealing gasket (Viton rubber).



6. Remove the sealing gasket.



7. Place all the above parts in appropriate cleaning solutions, preferably Viton rubber gasket/ o-ring and metal parts in different baths.

The metal parts can be immersed into a sonicator bath for thorough cleaning.

For suggestions to cleaning protocols, please refer to Q-Sense document *Cleaning and Immobilization Protocols*.

CAUTION!
The contact block of the flow module, with the electrode pins, should never be immersed in any cleaning bath!

8. Rinse all parts thoroughly in pure water, and blow dry with nitrogen or another inert gas.

Rubber Viton parts might need to be replaced from time to time. Check for more information in Chapter "Consumables and Accessoires".

5.7 Q-Sense Electrochemistry Module (Optional)



The Electrochemistry Module enables combined measurements of QCM-D and electrochemistry, where the sensor crystal acts as both the QCM-D sensor and as the working electrode of the electrochemistry cell. This module is described in a separate "QEC 401 Electrochemistry Module" user manual.

5.8 Q-Sense Window Module (Optional)

The Window Module was created to enable simultaneous microscopy studies or light-induced reaction studies and QCM-D.



The window module, together with its E1 lid.

- The Window Module works as the standard flow module: the same sensor crystals, and the same tubing connections are used.
- For maximum temperature stability, the blue lid should be put on top of the module, including the clear polycarbonate window (when you are not using it under a microscope).
- The thin window inside the module itself is made of sapphire glass.

Assembling the Window Module

When assembling the module, note the following:

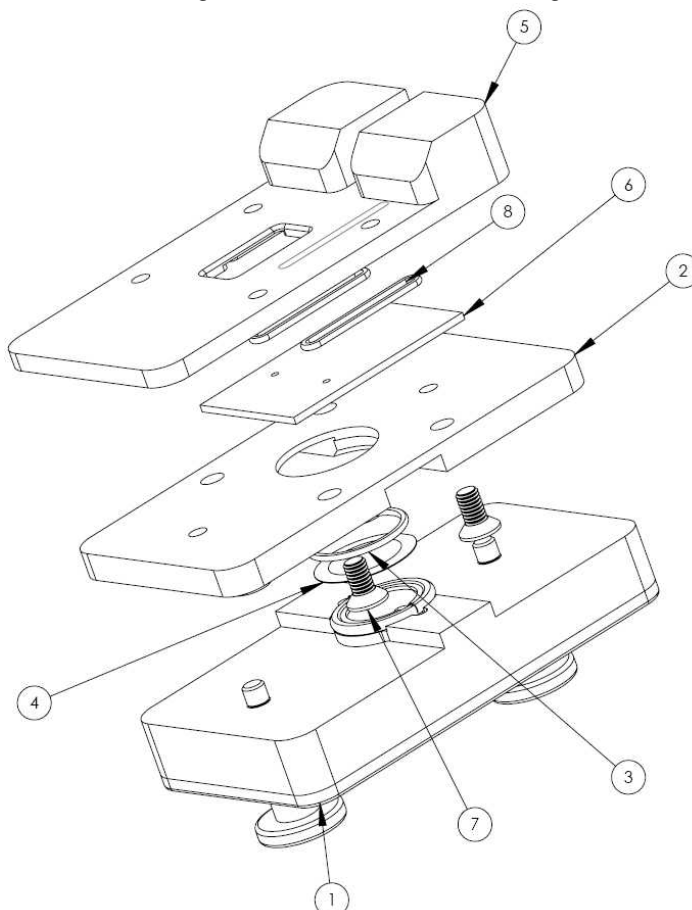

- The three o-rings have different dimensions than the standard flow module o-ring: 12x1mm (3) and (8)
- two o-rings (8) are stretched around the inlet and outlet channels (see picture below)
- The glass window piece (6) has two holes - make sure they match the inlet and outlet channel
- Take extra care when screwing the middle plate (2) to the upper plate (5). Overtightening the screws can crack the glass slide.



Cleaning the Window Module

The flow part is made of Titanium (as for the standard QFM 401 Flow Module), and standard o-rings are made of Viton®; hence, they should be cleaned according to Q-Sense standard cleaning recommendations (see www.q-sense.com). Windows can be cleaned with Hellmanex II cleaning solution for optical components or similar (see www.hellma-worldwide.com).

5-9 Q-Sense Ellipsometry Module (Optional)



- The Ellipsometry Module allows for simultaneous ellipsometry and QCM-D measurements on the same sensor surface. The module has two $\varnothing 2.5$ mm light paths for incident and reflected light beams to and from the QCM-D sensor. It has been designed to allow for flow measurements while keeping the sample volume to a minimum. Ellipsometry or other light sources are not supplied by Q-Sense. The angle of incidence is 65° , and equals the angle of reflection.
- The Ellipsometry Module can only be used with Q-Sense E1 chamber platform, as you need optical access from both ends of the module and the design of the E4 chamber platform does not allow for this.
- The radiated beam passes through a 2 mm thick plan optical window (1/4 Wave BK7) on each side of the module, and the sample liquid fills the whole interior including the channels from the sensor surface up to the windows.
- To ensure complete sample exchange and to avoid trapped air bubbles, there are two extra outlets via the window channels from the chamber, except for the two standard inlet and outlet ports.

Using the Ellipsometry Module

As for the standard flow module QFM 401, preparing a measurement includes:

- cleaning of the flow paths and sensor (see Q-Sense cleaning recommendations at www.q-sense.com)
- making sure that the 12x1 mm o-ring lies flat under the sensor
- inserting the sensor and closing the module



Ellipsometry Module ready for sensor mounting.

Further disassembly of the ellipsometry module is not necessary between measurements.

Note!

When connecting the three outlet ports to three parallel cassettes on a peristaltic pump, remember that the flow rate inside the module is 3-fold the value set on the pump!

Assembling the Ellipsometry Module

For thorough cleaning between experiments, and maintenance, the module can be disassembled completely:



- Module base with electrode connections

- Insulator lid

- Viton® sealing gasket

- Optical glass window w/ holder and o-ring (x2)

- Titanium flow part

- Module contact part C

- Teflon® tubing connector



Titanium flow part with window removed: When mounting the window glass, the o-ring should be put on the rim around the glass and then put into the cone-shaped bed on the Titanium flow part, so that the glass is resting on the Titanium.

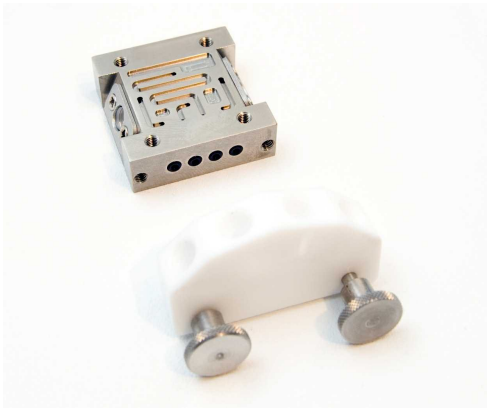

There is 1 inlet port and 3 outlet ports on the Titanium flow part. The corresponding inlet port on the Teflon® tubing connector is marked with a notch.

The four small o-rings sealing between the Titanium flow part and the Teflon® tubing connector can be removed for cleaning if necessary.



When assembling the module, place the Viton® gasket in the cut-out inside the black insulation lid and then put the Titanium flow part in place. While pressing the three parts together, flip the lid around and screw in the four screws. Tighten the screws in an alternating fashion to ensure that the lid ends up laying flat on the Titanium part.



Make sure the 14x1 o-ring is in place on the lower part of the Titanium flow part. Then screw the Titanium part and insulator lid onto the module contact part C with four screws.

Note!

The anchor-shaped sensor direction indicator should point with its bottom towards the inlet and outlet ports on the Titanium center piece.



Assembled module flow part.

Note!

When assembling the Teflon® tubing connector to the module, do not overtighten the thumb screws, since Teflon® is a soft material! Only a light pressure is needed for the o-rings to seal properly. When you feel the resistance in the screw, tighten it about 1/4 turn.

Cleaning the Ellipsometry Module

Please refer to the standard cleaning recommendations by Q-Sense (search our website for Cleaning and Immobilization to find the documents) as the ellipsometry module is made of our standard materials (Titanium flow part, Viton® o-rings and gasket).

5.10 Q-Sense Humidity Module (Optional)

The Humidity Module has a short flow path over an exchangeable Gore™ membrane, allowing for controlled humidity measurements. By using different saturated salt solutions above the membrane, the relative humidity above the sensor can be altered.



Above: The assembled humidity module with the membrane visible under the sensor seating. Right: included parts, with GORE™ membrane mounted.



When using the Humidity Module, remember the following:

- The sample liquid has to be pushed through, rather than drawn through, as the membrane may otherwise allow for air to be drawn into the system.
- It is recommended not to use higher flow rates than around 100 ul/min to avoid creating too high pressure onto the filter.

Tabled Relative Humidity for Salts

Below is a list of relative humidity values (RH) for some standard salt solutions at temperature 25°C. By using these saturated solutions, a series of humidity values can be created and used with the Humidity Module.

Salt	RH (%)	St. Dev.
CsF	3,39	0,94
LiBr	6,37	0,52
ZnBr ₂	7,75	0,39
KOH	8,23	0,72
NaOH	8,24	2,1
LiCl	11,3	0,27
CaBr ₂	16,5	0,2
LiI	17,56	0,13
CH ₃ COOK	22,51	0,32
KF	30,85	1,3
MgCl ₂	32,78	0,16
NaI	38,17	0,5
K ₂ CO ₃	43,16	0,39
Mg(NO ₃) ₂	52,89	0,22
NaBr	57,57	0,4
CoCl ₂	64,92	3,5
KI	68,86	0,24
SrCl ₂	70,85	0,04
NaNO ₃	74,25	0,32
NaCl	75,29	0,12
NH ₄ Cl	78,57	0,4
KBr	80,89	0,21
(NH ₄) ₂ SO ₄	80,99	0,28
KCl	84,34	0,26
Sr(NO ₃) ₂	85,06	0,38
KNO ₃	93,58	0,55
K ₂ SO ₄	97,3	0,45
K ₂ CrO ₄	97,88	0,49

Reference: *Humidity Fixed Points of Binary Saturated Aqueous Solutions*, Lewis Greenspan, Journal of Research of the National Bureau of Standards - A. Physics, and Chemistry Vol. 81A, No 1, January-February 1977.

5.11 Q-Sense Open Module (Optional)

The Open Module does not include any flow channels or connectors. It is designed for minimized sample volumes, and depending on the surface and liquid properties, samples can be between 10 and 50 µl. When using it, remember that the lid is important to reduce disturbance from the ambience, as the sensor is very vulnerable in this open mounting. Samples are deposited right onto the sensor surface.



Note!

When mounting the Open Module on the chamber platform, make sure the electrode pins are in position above the connecting plates on the platform; As there are no tubing ports on this module, it may be easy to place it 180°C wrong.

6 QSoft 401

Note!

It is assumed that the user is familiar the Windows operating system and can perform common tasks such as saving and opening files. If not, please refer to the Windows manual that came with the PC. Only QSoft401 specifics are described in this manual.

Open QSoft401 via the Start Menu, or via the path C:/Program Files/Q-Sense/QSoft 401 (if you used the default installation path).

6.1 Main Window



When the electronics unit is turned on, the **Temperature Control** can be accessed. It is recommended to turn this on first, so that the Chamber platform and flow modules can stabilize while continuing with other settings. If the temperature control was turned on before the instrument was shut down last time, it will turn on automatically.

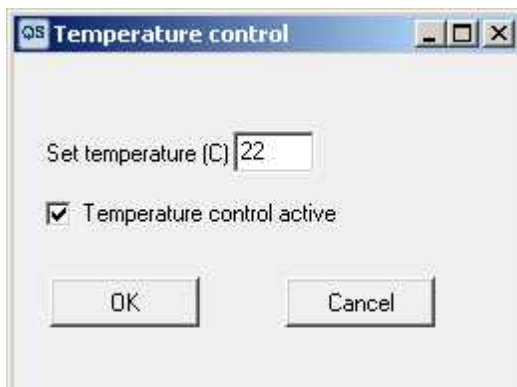

Click on the Temperature control panel on the main window to open the temperature settings window.

Insert the desired value and click "OK".

6.2 Setup Measurement

To start a measurement, the resonance frequencies of the sensor crystals first must be found. The resonances constitute the baselines of each crystal. This is done under **Setup Measurement** in the **Acquisition menu**. The menu is available only when the instrument has been turned on.



(The QAutoController function is only available if you have the Q-Sense QAuto Liquid Handler table connected to your instrument. See separate manual).

Find Resonances

Choose your crystals included in the measurement

Search all resonances or a specific one

Included crystals

Crystal	1	2	3	4
Include	<input checked="" type="checkbox"/>	<input type="checkbox"/>	<input type="checkbox"/>	<input type="checkbox"/>
Fund. F (MHz)	4.95	4.95	4.95	4.95

Included resonances

Res \ Xtal	1	2	3	4
1st	<input checked="" type="checkbox"/>	<input checked="" type="checkbox"/>	<input checked="" type="checkbox"/>	<input checked="" type="checkbox"/>
3rd	<input checked="" type="checkbox"/>	<input checked="" type="checkbox"/>	<input checked="" type="checkbox"/>	<input checked="" type="checkbox"/>
5th	<input checked="" type="checkbox"/>	<input checked="" type="checkbox"/>	<input checked="" type="checkbox"/>	<input checked="" type="checkbox"/>
7th	<input checked="" type="checkbox"/>	<input checked="" type="checkbox"/>	<input checked="" type="checkbox"/>	<input checked="" type="checkbox"/>
9th	<input checked="" type="checkbox"/>	<input checked="" type="checkbox"/>	<input checked="" type="checkbox"/>	<input checked="" type="checkbox"/>
11th	<input checked="" type="checkbox"/>	<input checked="" type="checkbox"/>	<input checked="" type="checkbox"/>	<input checked="" type="checkbox"/>
13th	<input checked="" type="checkbox"/>	<input checked="" type="checkbox"/>	<input checked="" type="checkbox"/>	<input checked="" type="checkbox"/>

Find all resonances

Quick-check found resonances
 Autostart measurement

Find specific resonance

Crystal: 1 Res.: 5th

Xtal: Res	F (Hz)	D (1E-6)
1: 1st	495604.6	334.6
1: 3rd	1485042.7	180.3
1: 5th	2474766.5	134.8
1: 7th	Not found	Not found
1: 9th	Not found	Not found
1: 11th	Not found	Not found
1: 13th	Not found	Not found

Resonance optimization

Automatically optimize all resonances
 Acquisition speed vs low noise
 High speed Low noise

Individual resonance settings

Crystal: 1 Res.: 1st

1st Xtal / 1st Res	Auto Value
Center freq (MHz)	4.9500
Freq range (kHz)	<input checked="" type="checkbox"/> 500
Drive amplitude	<input checked="" type="checkbox"/> 1.1
Drive time (ms)	<input checked="" type="checkbox"/> 2
Decay amplification	<input checked="" type="checkbox"/> 10.2
Decay length	<input checked="" type="checkbox"/> 768
Decay average	<input checked="" type="checkbox"/> 16
Decay sample rate (MHz)	<input checked="" type="checkbox"/> 1.9

Sweep

Amplitude vs Frequency (Hz)

Decay

Amplitude vs Time (ms)

X = 24 502 414 Y1 = 0,1301

The crystals to be included in the measurement are chosen in the **Included crystals** window. The number of harmonics to be recorded from each crystal are chosen in the **Included resonances** window.

To find the resonances of a crystal (i.e. to find its baseline and overtones), click **Find all resonances** or **Find specific resonance**. QSoft will then start a search to find the resonant frequencies. A sweep chart will appear where the resonant amplitude versus frequency is shown in the **Sweep** window. If the sensor crystal has a resonance in the specified range, the sweep curve will contain a peak. QSoft will use the peak with the largest deviation from the mean of the sweep and use this frequency, f_1 , as a starting value

for the resonance frequency fitting. The electronics unit will then excite the crystal with a drive signal with frequency f_1 . After the drive signal is turned off, a decay curve is acquired, and QSoft calculates the measured f and D values from the sensor crystal's decay curve by doing a numerical fit. The decay curve and the fit are shown in the **Decay** curve window.

For most conditions, it is recommended to use the standard settings chosen automatically by the program, by having the box **Automatically optimize all resonances** ticked in the **Resonance optimization** window.

If there would appear any problems in finding the resonances, it is possible to individually adjust the settings for each resonance on each sensor crystal by un-clicking the **Automatically optimize all resonances** tickbox. A settings window will then appear:

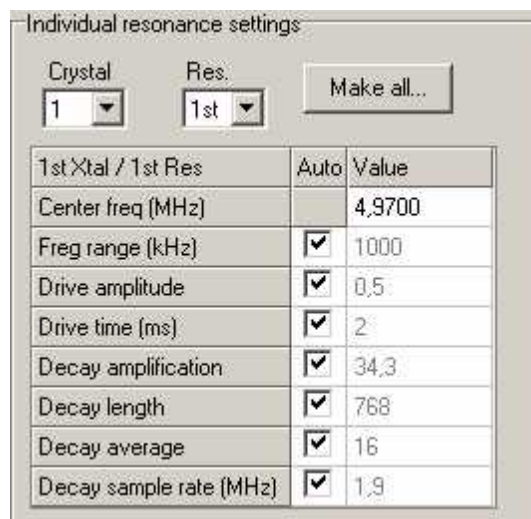

Center frequency (MHz)

Sets the median frequency value around which the resonance search should be done. For instance, the fundamental frequency of a standard non-coated sensor crystal is around 4.97 MHz.

Frequency range (kHz)

Sets how large the frequency interval around "Center Frequency (MHz)" should be.

Drive amplitude

Determines the amplification of the drive amplifier, i.e. indirectly how much voltage should be applied over the sensor to excite it into oscillation. Normally 0.5-1.0 is enough. The actual voltage across the sensor crystal depends on the current D value. For a given D , drive amplitude is proportional to the voltage across the sensor.

Drive time (ms)

Sets how long the sensor crystal should be excited before the voltage is turned off and the decay curve is recorded. This setting seldom needs to be changed.

Decay amplification

Sets the amplification level of the signal from the sensor before it reaches the analog-to-digital converter.

Decay length

Sets how many data points should be collected for the numerical fit.

Decay average

Sets how many decay curve fittings should be calculated before presenting an averaged value on the screen. 16 is the default setting. Lower values will give higher time resolution, but also more noise.

Decay sample rate (MHz)

Sets how detailed the data point collection should be for fitting of the decay curve. For air measurements, around 0.5 is recommended, for water measurements, a value around 2 is recommended. Since the decay is much quicker in water than in air, more data points need to be collected before it has leveled out, and a higher sampling frequency is needed.

Different types of measurements demand different time resolution. If very fast processes needs to be followed on the screen, higher amount of data points per minute are sampled by moving the pin below towards **High speed**. The trade-off is higher signal-to-noise ratio.

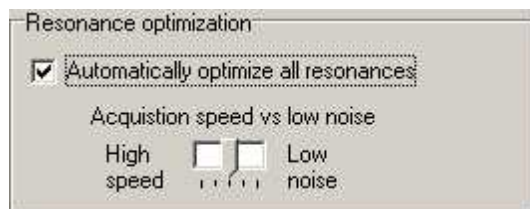
**Temperature Programming**

If temperature changes are desired during a measurement, they can be programmed in the **Temperature** tab under **Setup Measurement** in the **Acquisition** menu. In order to activate programmed temperature control select the Programmed radio button. Temperature control will automatically activate (if it not was so before) when turning on programmed temperature control.

Crystals
Temperature

Type of control
 Manual
 Programmed

Set temperature (C)

Temperature control active

Step	Temp. (C)	Time (min)	Slope (C/min)
1	25	5	0
2	25	10	1
3	35	5	0
4	35	10	-1
5	25	10	0
6			

Loop
 Use loop
 Return to step

Default ramp time (minutes)

A temperature program consists of a number of steps (at least two). For each step there is a starting temperature and a time. The time denotes how long it should take before reaching the temperature of the next step. The temperature slope is automatically calculated based on the temperature difference between current row temperature and the next and how long time is specified.

The temperature program, if activated, will start as soon acquisition starts. It is therefore advisable to let the first and second step have the same temperature to let temperature stabilize first. When the program reaches the end it either stops or, if "Use loop" is checked, returns to the step indicated.

The "Default ramp time (minutes)" edit box only determines the default time entered in the Time cell for a new step in the program.

You can save (or open) a temperature program by clicking the obvious button.

6.3 Measurement Windows

To start an acquisition, click **Start Measurement** in the **Acquisition** menu:

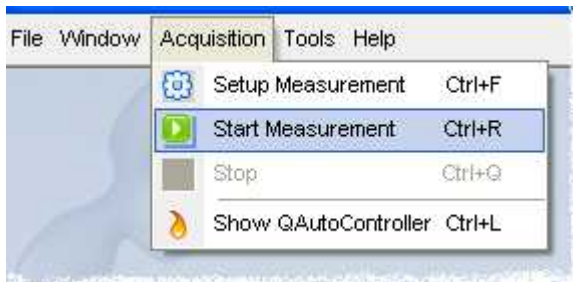

When starting the acquisition, one f and D vs Time chart for each included sensor crystal will appear. These charts will be watermarked with the number 1 through 4 (for E1 users, only one sensor is available). In addition to these charts, one notes panel (with a simple text editor), a temperature chart and a table with absolute values for f and D are displayed. The visibility of these panels can be controlled with the buttons in the toolbar. In the figure below, sensor 1, 2, and 3 has been hidden while all the rest of the windows are visible.

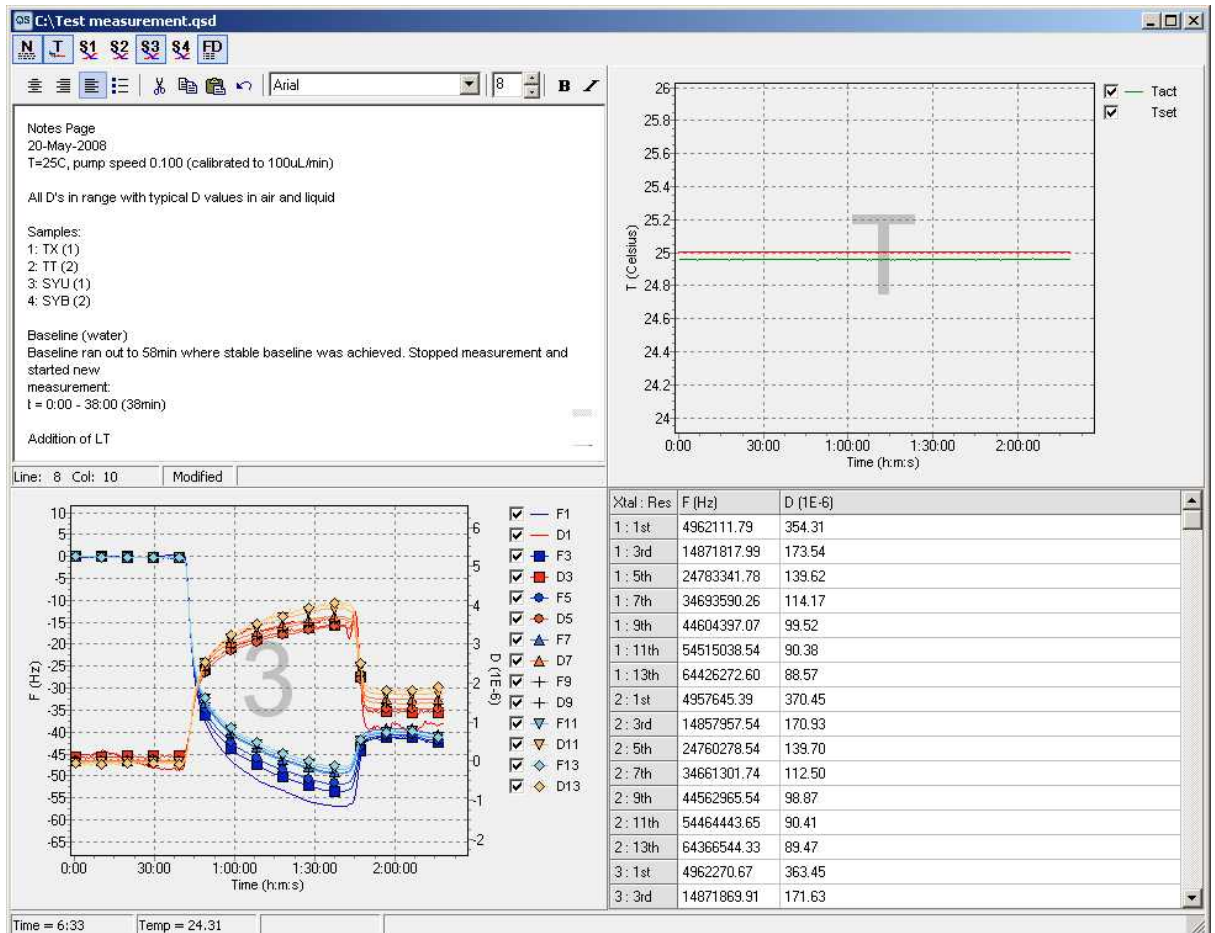

The watermark numbers in the background of the graphs refers to the slots 1-4 on the chamber platform.

You can show or hide these charts and panels by clicking the corresponding button in the toolbar. Also, double-clicking a panel hides all other panels.

Notes panel

The notes panel lets you keep an experimental log that is saved consists of a simple rich-text editor which has the most basic text editing capabilities. You can copy and paste text to and from other text editor, such as Microsoft Word but only features compatible with the rich-text file (*.rtf) format can be handled.

F and D chart panels

Acquired frequency values are plotted in various hues of blue and presented on the left hand axis, while dissipation values are plotted in red to yellow hues and presented on the right hand axis:

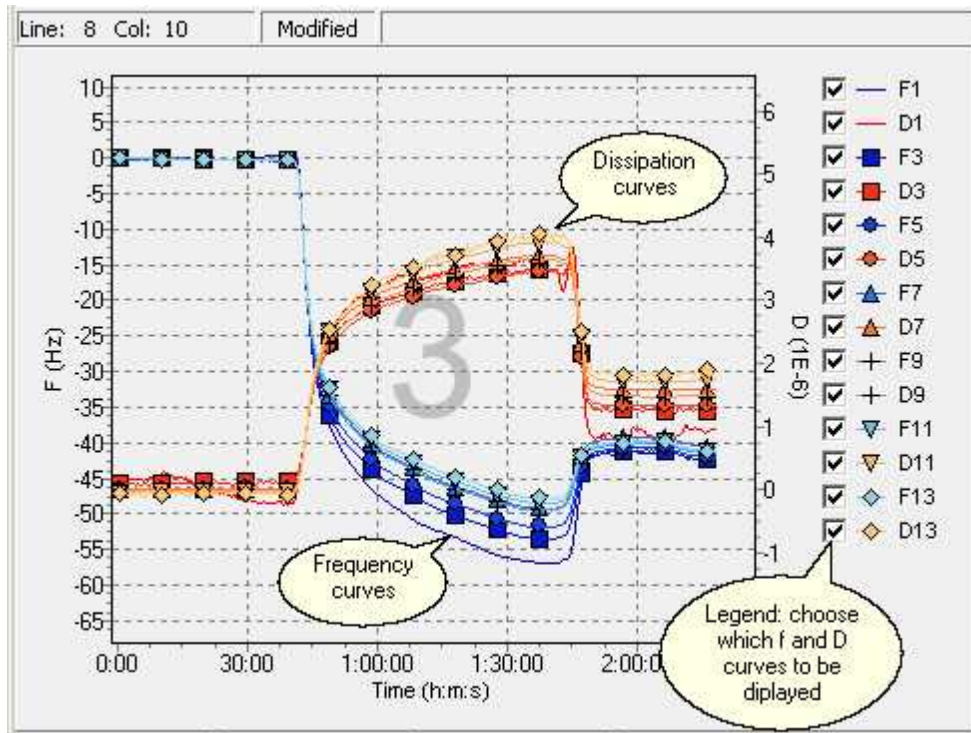

Note that the f and D values are automatically offset so they all start at zero.

For quick setup of displayed f and D curves, use the right mouse button menu in the measurement window:



The offset function allows you to choose a different time than time zero for which all the curves are offset to zero.

Zooming

To zoom in on a specific area of a chart, hold the left mouse button and drag the mouse down and to the right. A rectangle will appear around the selected area. Release the left mouse button to zoom. You can continue zooming again and again.

To restore (or undo) the zoom, drag a rectangle in the opposite direction (up/left).

If you hold down the Shift key during a zoom, the x-axis will not be zoomed.

If you hold down the Ctrl key during a zoom, the left y-axis will not be zoomed.

If you hold down the Alt key during a zoom, the right y-axis will not be zoomed.

You can combine the Shift, Ctrl, and Alt keys as you like to zoom in on any combination of the axes.

The chart will scroll by clicking the right mouse button anywhere on the chart, holding down the mouse button, and then moving it (along with the chart) around.

Temperature panel

The graph displays the Set temperature (in red color when turned on and blue when turned off) and the Actual temperature (in green color). Since Tset can be both blue and red in the chart, it does not have a colored line after the check box like Tact.

F&D table panel

To see the absolute values of each resonance, open this table. It is the last acquired values that are displayed.

6.4 Terminating a Measurement

To stop the acquisition, select the **Acquisition/Stop** menu item. Stopping an acquisition may take a few moments depending on where in the acquisition cycle the stop was issued.



A **Save file** dialogue will appear. Enter a file name and click **Save** to save your data.

QSoft continually saves the measured data during an acquisition in a temporary data file called xxx.-qd (where xxx is a number) located in the local user directory C:\Documents and Settings\ [User's account] \Application Data\Q-Sense\QSoft. The temporary data file is created after 10 minutes, and then updated after every new 10 minutes measured. The file is removed when the user saves the measured data. If, for some reason, a measurement is abnormally terminated before you have a chance to save your measured data, next time QSoft401 is started it will check the directory for temporary data files. If it finds a temporary file it will open it and prompt you to save it.

6.5 Condense a measurement

The number of data points in a data file depends the [speed vs low noise setting](#) in measurement setup and for how long the measurement has been going on. If the data file you have acquired turn out to unmanageably large you can use the condense function of QSoft. You find it under the File menu.

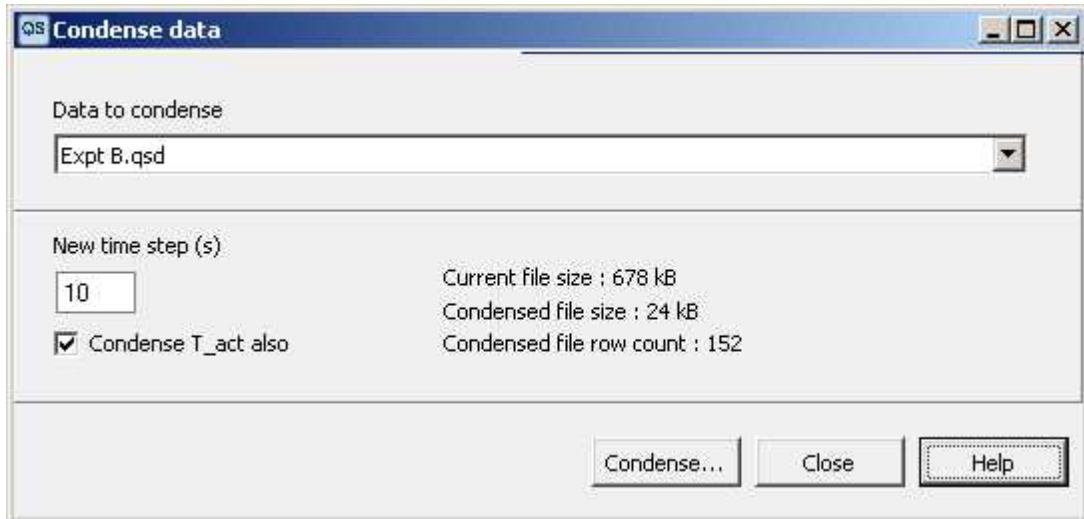

The condense function works by creating a new time step vector (column in QTools) and then calculate what the frequency or dissipation values should be at each of these new time steps. QSoft does so by fitting a second degree polynomial to all the points that fall between the new time step just before and the new time step just after the new time step that is currently being calculated (the first and last time step is little different). Say that your data file contains a frequency data point from fifth overtone of sensor 1 every second and you have specified a new time step of 10 s. Then for, say, the time step a 50 s, the new frequency will be calculated from the polynomial that best fits the measured data points recorded between 40 and 60 s.

If you want the measured temperature to be calculated in the same manner for the new time steps, check the "Condense T_act also" tick box.

6.6 Stitch data files

If you have made two measurements you may sometimes want to analyse the data as one data set. For example, you have spin coated a sensor and you have measured the sensor before and after coating. To stitch these two data files together would make for an easier analysis in QTools.

Open the two data files you want to stitch together and select **Stitch Data Files** from the **File** menu.

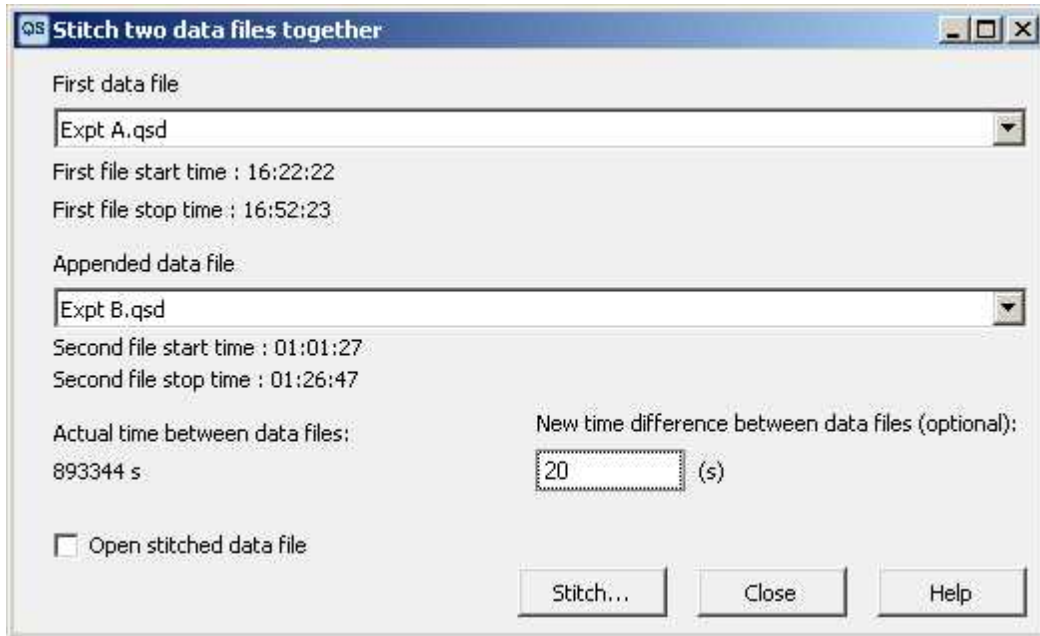

You can either manually set how large time gap it should be in the new data file between the two measurements or let QSoft use the actual time difference. If the first data file was recorded after the data that is to be appended, you have to set a new time difference.

If the "Open stitched data file" check box is ticked then the new stitched file will be opened by QSoft when the operation is finished.

7 Your First Measurement

Get familiarized with your QCM-D instrument! In the standard shipment accessories, there is a set of samples for a simple first test measurement: one vial of Diethylaminoethyl-Dextran (DEAE-Dextran) and one vial of Dextran Sulphate Sodium salt (described in detail in the package).

1. Mount a standard Au sensor crystal, cleaned according to the separate cleaning protocols.
2. Connect the provided tubing to a flow module and fill it with distilled water.
3. Start QSoft and set up the measurement according to Chapter "QSoft 401/Find Resonances".
4. Start a measurement, and establish a baseline in flow conditions at 150 $\mu\text{l}/\text{min}$:

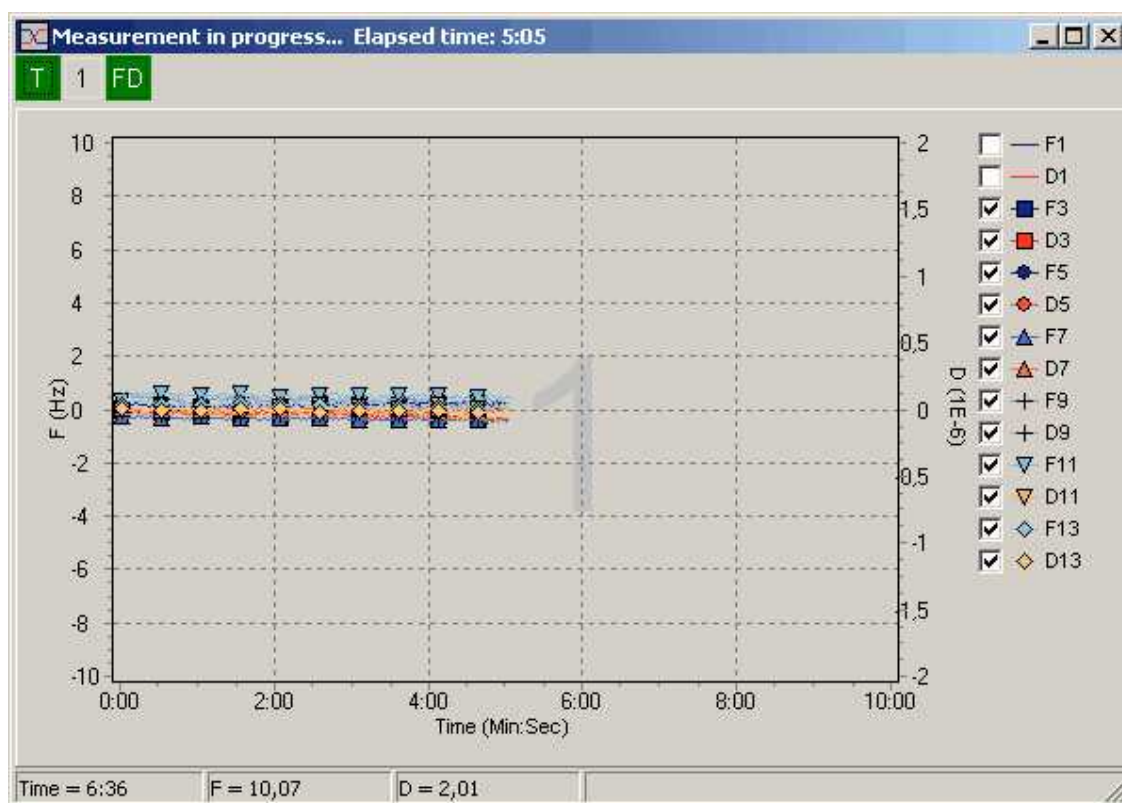

5. Stop the pump shortly and put the tubing into the **DEAE-Dextran** vial. Start the pump again and await adsorption (make sure no bubbles are introduced when switching between vials). After stabilization, stop the pump, switch to the **Dextran Sulphate** solution and start the pump again. By alternatively flowing the two positively and negatively charged polymers over the surface, a multilayer will build up.

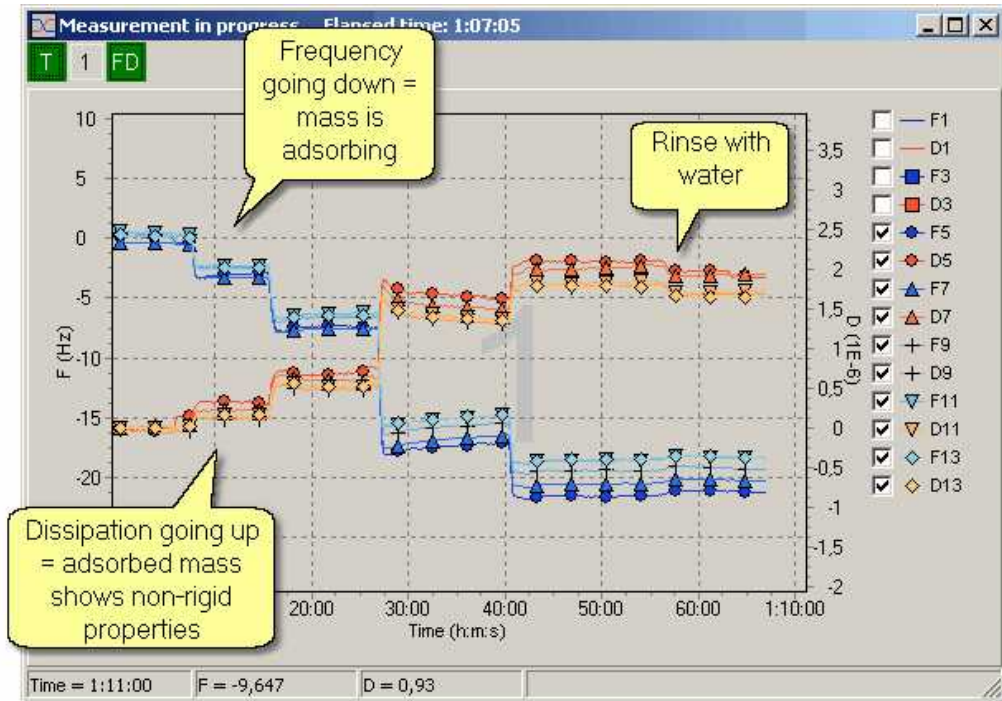

6. Point of interest: watch how the frequency and dissipation recover slowly, starting around the build-up of the third or fourth layer. Why does this happen? The reason is that the molecules first adsorb rather quickly, and then starts to organize themselves on the layer below. By that they form a more packed structure, leading to water release from the film. The **decreasing dissipation** indicates the film is getting more rigid by this, and the **increasing frequency** reflects the released water.

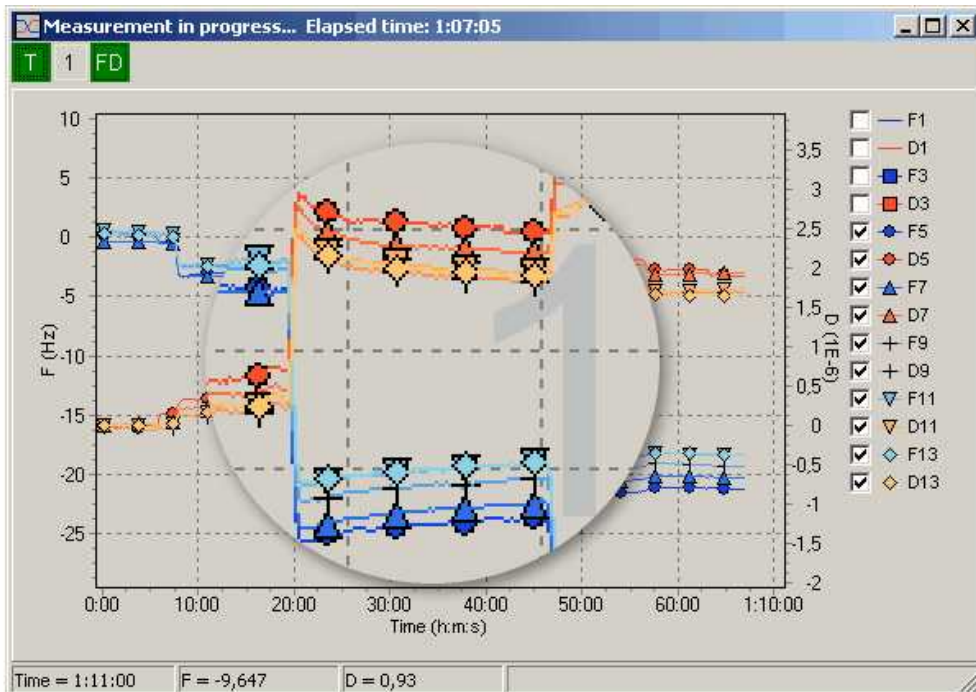

8 Troubleshooting

8.1 Prior to Measurement

The instrument does not start:

1. Check that the power cord is connected.
2. Check that the voltage rating on the back panel of the instrument is properly set for local voltage conditions in the lab. If not, open the plastic cover and turn the drum so that the right voltage is read through the window. Check that the fuse is not blown.

There is no connection with the instrument:

1. Check that the USB cable is plugged into the PC and the instrument.
2. Check if the hardware "Q-Sense E-Series Device" is found and installed on your computer. If not, open the installation file found in the C: directory under Program Files/Q-Sense/QSoft 401. Follow the instructions (see also sub Chapter "Installing Software"). The software should be installed before the instrument is started for the first time.
3. Check that you have the file "Driverx.sys" installed in the folder "C:\WINDOWS\system32\drivers". If it is not there, please contact Q-Sense to receive this file.

8.2 When Starting a Measurement

No resonance peaks can be found

1. The settings to drive the sensor crystal may need to be adjusted if the resonance frequency lies outside the search range specified in the settings. Uncheck "Automatically optimize all resonances" in the "Find resonances" window and widen the frequency range under "Individual resonance settings", until a resonance peak appears visible.
2. The sensor resonance may be too damped. The damping can become too high if the medium in which the sensor is emerged is too viscous or has high density. A film attached to the sensor can also cause heavy damping as can certain defects in the sensor. In this case the resonance peak in the sweep chart is small and can even be hard to distinguish from the background noise.
 - a) Verify the crystal is installed correctly and/or not broken.
 - b) Check whether a frequency can be found with another clean sensor or with less load on the sensor.
 - c) In some cases the sensor can still be forced to resonance by optimizing the acquisition settings. Check the effect of changing Drive amplitude under "Individual resonance settings" in the "Find resonances" window. By narrowing the "Frequency range", the resonance peak may become more pronounced.

The resonance frequency can be found but shortly after starting data acquisition the frequency is lost again, resulting in the error message "Warning bad fitting of the decay curve".

1. The loading of the sensor may be changing very fast so that the changes in frequency and dissipation cannot be tracked by the program. Possible solutions:
 - a) Increase the data acquisition speed. Optimal speed is obtained by changing the settings under "Resonance optimization" in the "Find resonances" window. Move the pin towards "High speed".
 - b) Make sure no external environmental changes affects the measurement (especially if you are measuring in open air).
2. The sensor may get more and more loaded during data acquisition and at some point the sensor cannot be driven anymore since the damping becomes too high. Solution: In some cases the sensor can still be forced to resonance by optimizing the settings for acquisition. Check e.g. the effect of changing "Drive amplitude" under "Individual resonance settings".
3. Try using a sensor with lower load.

The D values are outside specified values

1. If an overtone has a high D value, it is an indication of a bad resonance peak. Check that it is not divided (consisting of two peaks). There is no risk for incorrect measurement data, but the overtone could give higher noise than normally, since the program does not have a clear peak to follow.
2. If all D values are high: check that the o-ring has the right dimensions (1.6 mm thick for the standard flow module, 1 mm for the window module), or if the crystal does not lie horizontally on the o-ring.

8.3 During a Measurement

The measurement shows excessive noise

1. Check that the crystal is mounted correctly with the arrow-shaped electrode towards the mark on the crystal holder (to the left). See sub Chapter "Mounting the Sensor Crystal" in Chapter "Operation". If the sensor crystal is mounted in the wrong direction, the grounding of the electrodes will not be optimal, and disturbing leaking currents may interfere with the measurement.
2. If the sensor crystal has scratches or damages on its surface, this may give rise to non-wanted disturbing resonance peaks, seen adjacent to the true resonance peak in the frequency sweep window. If these disturbing modes are of the same amplitude as the true one, the instrument may jump over and follow them instead. If a false or non-pure resonance peak is followed, it could result in high noise.
3. A sensor crystal loaded with an inhomogeneous coating or a coating with high surface roughness could also give rise to non-pure resonance peaks and thus higher noise.
4. Check for bubbles, or if measuring in air, residual liquid on the crystal or in the flow module.

The dissipation curve shows negative values

Theoretically there cannot be any negative D values.

1. Make sure that it is the absolute baseline that is followed. Could there be any pre-treatment or contamination that have added mass to the surface?
2. Changing of bulk liquids above the surface means that new liquid properties will be sensed. The f and D shifts may go either up or down when going from one liquid to another, and it may be hard to predict which way to expect.
3. If the sensor crystal is loaded with a substantial amount of mass (several hundreds of nanometers), there can be internal stresses induced to the crystal, which may be released while changing the conditions during a measurement. This kind of sudden processes could result in a drop in D .

The noise is increasing with time in an ongoing measurement

1. The properties of the film on the sensor may have changed so much that the settings to drive the sensor are no longer optimal, i.e., the damping of the sensor has changed significantly. Check whether the noise can be decreased by adjusting the settings Decay sample rate under "Individual resonance settings" in the "Find resonances" window.
2. The film on the sensor may have become more inhomogeneous with time. Solution: Accept it...

The resonance frequency is lost resulting in the error message "Warning: bad fitting of the decay curve"

1. The environment of the sensor may be changing very fast, so that the changes in frequency and dissipation cannot be tracked sufficiently. Solutions:
 - a) Increase the data acquisition speed. Optimal speed is obtained by changing the settings under "Resonance optimization" in the "Find resonances" window. Move the pin towards "High speed".
2. The sensor has been more and more loaded during data acquisition and at some point the sensor cannot be driven anymore as the damping becomes too high. Solution: In some cases the sensor can

still be forced to resonance by optimizing the settings for acquisition. Check the effect of changing "Drive amplitude" under "Individual resonance settings".

The measured signals show drifts

Normally, a clean 5MHz sensor crystal operated at $25.00 \pm 0.01^\circ\text{C}$ should drift $<0.5\text{Hz}/\text{hour}$ ($<1.5\text{Hz}/\text{hour}$) in the frequency values and $<2 \cdot 10^{-8}$ /hour ($<2 \cdot 10^{-7}$ /hour) in the dissipation values in air (water) when measured at 15Mhz harmonic.

1. **Leaks.** If a tube is leaking, or the crystal is not properly mounted (or even cracked) this can cause liquid to enter spaces in the measurement chamber where it should not be. For example if the back side of the crystal becomes exposed to only small amounts of liquids or vapors large changes in f and D may occur. Also, if liquids enter the electrical parts of the measurement chamber large variations in the measured signal may result.

Solution: Eliminate leaks. Check for leaks by mounting a crystal in a dry measurement chamber. Close the outlet tube. Then fill a syringe with air and connect it to an inlet tube. Press gently for about 30 seconds and then release. You have a leak if the syringe does not return to the initial state. Check that ferrule connections are tight and the tubing is cut flush at the end. Check that the sealing gasket is seated properly.

2. **Bubbles.** Gas bubbles may form on the surface of the crystal if you use a liquid that is not properly degassed. Such bubbles will of course influence f and D . For example, the gas solubility of water decreases when the temperature is increased. If water with a lower temperature than the measurement chamber is injected, then there is a large risk for formation of bubbles. Note that the risk for bubble formation generally increases with decreasing salt concentration of a water solution.

Solution: Use only degassed liquids or make sure that the gas solubility of the liquid is not lowered during the measurement. Bubbles can often be removed by connecting a syringe at the outlet and a reservoir to the inlet and then vigorously pump liquid back and forth with the syringe. However, be careful not to introduce any new bubbles or contaminants.

3. Temperature changes.

a) The measurement chamber is temperature stabilized but large variations in the environment may not be fully compensated. Temperature changes will change the viscosity and density of a liquid and thereby change f and D . Large temperature changes of the electronics unit will also change the frequency of the reference clock. This will directly change the measured frequency (but not dissipation).

Solution: Make sure the temperature controller is turned on! Keep a constant environment around the measurement chamber and the electronics unit. Make sure air circulation is adequate and constant around the measurement chamber and electronics unit. Avoid sunshine and air-streams (e.g., from an air-conditioner) to be pointed directly at the instrument.

b) At certain temperatures the resonant modes may coincide with unwanted modes that are very temperature dependent. If measuring at such a point, the signal may be affected and drifts occur.

Solution: Change the temperature slightly to "come loose" from the mode intersection.

4. **Surface reactions.** The QCM-D is designed to measure surface reactions. However, sometimes there are reactions going on that the user does not anticipate. For example, on a bare gold crystal in contact with water there may be a slow change of the ion content in the Helmholtz double layer. There might also be a slow transfer of contaminants from the chamber walls to the crystal surface. Or there might be a slow desorption, degradation, or restructuring of the surface layer on the crystal. It is also not uncommon that, a crystal with a polymer coating absorbs or desorbs solvents or even water that will change the measured mass. These kinds of "drifts" often induce relatively larger shifts in f than in D (just like most measurements of very thin films do). The frequency "drifts" then follow the mass sensitivities of the overtones, i.e., the shifts in frequency goes as 1:3:5:7... for the fundamental and the 3rd, 5th, and 7th overtones and so on.

Solution: This is not really a drift since it is a result of surface processes, which the QCM-D is designed to measure. You can check if some kind of surface process is the cause of the "drift" by passivate the crystal surface. We have found that passivation of the crystal by lipid layers, proteins, or thiols have significantly reduced these kinds of "drifts". It is also important to thoroughly clean all parts of the chamber regularly. It may be necessary to exchange all tubing and the o-ring for new ones.

5. Pressure changes. If your measurement set-up has the pump positioned before the flow module and the outlet tube hanging free on the other side of the flow module, evaporation from the end of the outlet tube may occur. Then the pressure on the crystal will change as the liquid level changes. You can easily test how much this pressure changes f and D by starting a measurement in liquid and then slowly move the end of the outlet tube up and down. The same thing can also happen if the valve into the crystal is slowly leaking. Then the pressure (and possibly the temperature) can slowly change causing a drift.

Solution: Have the pump connected *after* the flow module. If having the outlet tube in free air, the best thing would be if the last stretch of the tube were horizontal. Then a small evaporation from the end of the tube will not change the water level and hence not the pressure felt by the crystal. It is also possible to put a valve at the end of the tube which stops evaporation altogether.

6. Mounting stresses. Most physical stresses on the crystal influence all resonant frequencies and dissipation factors even if the effects are usually more pronounced in the fundamental mode than the overtones. Mounting the crystal in a chamber will inevitably induce crystal stresses since the o-rings and the gold contact wires all exert a force on the crystal. If these forces are held absolutely constant during the run of the measurement, they will usually not cause a problem. Any changes in these stresses will, however, more or less, induce changes in f and D . For example, if the crystal is unevenly placed on the o-ring there might be a slow creep in the o-ring that will change the mounting stresses. Also, changes in temperature will change the diameter and elastic properties of the o-rings as well as the dimensions of the measurement chamber by tiny amounts. This may be enough to significantly change the mounting stresses.

Solution: Be careful when mounting the crystal to make sure it is placed evenly and centred on the o-ring. Make sure the o-rings and crystal are clean and free from dust particles. Stresses can sometimes be released by knocking hard with one finger on the flow module.

7. Backside reactions. The backside of the crystal is as sensitive to surface reactions as the front side. If, for example, there is a large change in humidity on the backside of the crystal due to leaks or a large change in temperature, the amount of adsorbed water will change and thereby influence f and D . Note that the volume at the backside of the crystal is in contact with the ambient through the holes for the spring-loaded contacts.

Solutions: Make sure the dew point of the air around the chamber platform (which is in contact with the backside of the crystal) is significantly higher than the measurement temperature. See also Leaks above.

8. O-ring swelling. Upon changing from working in one solvent to another, the o-ring might swell/shrink due to the changed properties of the liquid (see also Mounting stresses above).

Solution: Use different o-rings for different solvents, or pre-soak for a couple of hours when changing from one liquid to another.

9. Bad electrical contact. The measured dissipation factor will increase if there is a bad electrical contact (high electrical resistance) between the crystal and the gold contact wires. This will increase noise and possibly also drifts. Indicative of this problem is that a clean crystal has a high dissipation factor ($> 40 \times 10^{-6}$) when measured in air.

Solution: Make sure the crystal is properly mounted so that the gold contact wires will make good contact with the crystal electrodes. Look in the manual if you are unsure how the crystal should be mounted. It is important that the backside electrodes are clean. This can be a problem if the front side of

the crystal has been spin-coated with a non-conducting layer, which easily can spill over the edge of the crystal. Make sure the gold contact wires are undamaged and sitting firmly around their o-ring.

When rinsing with liquid the signal does not return to the baseline or becomes unstable.

1. There may be bubble formation on the sensor. In case bubbles are trapped in the vicinity of the sensor, the measurement signal often does not return to the original baseline after rinsing. Moving bubbles make the signal unstable.

Solution: Avoid the formation of bubbles. Preferably use degassed liquid. Do not insert liquid with a temperature below the working temperature of the measurement chamber, as dissolved gas can be released during heating (see also sub Chapter "Running a measurement").

2. Contaminants in the sample liquid can induce instability. Check the quality of the samples.

3. The sensor may be experiencing a "pressure shock". Irreproducible jumps in f and D can occur if the sensor is mechanically stressed by increasing the pressure on one side of the sensor when a fluid is forced through the measurement chamber. Try to not use too high pump flow rates.

4. The sensor may be experiencing a "temperature shock". Irreproducible jumps in f and D can occur if the sensor is thermally shocked, i.e., rapidly changing the temperature of the sensor. Make sure to keep sample solutions at roughly the same temperature as the Set temperature. Also, do not exceed a rinsing speed above 1 mL/min to allow the sample to stabilize at the Set temperature in the flow module before reaching the sensor surface.

The fundamental frequency is less stable than the overtones.

The fundamental frequency is much more sensitive to the mounting of the sensor and the conditions of the sample environment than the overtones.

- Small improvements might be made by remounting the sensor crystal and checking the quality of the sample liquid.
- Only collect data from the overtones (recommended).

8.4 After a Measurement

I find liquid outside the crystal sensor area after opening the flow module

Liquid on the "anchor side" of the sensor crystal is severe for QCM-D measurements. If the backside of the sensor crystal is facing any droplets of liquid, slow humidity stabilization processes will affect the f and D baselines, and destroy any attempt to make qualitative measurements. For prevention:

- Check that the crystal does not have any cracks or notches at the edges. Such damage may reduce the sealing capability of the o-ring.
- Check that the crystal is centered over the o-ring.
- Check that the tubing connections are tight. Is there any liquid outside the black nut? It is very important that the Teflon tubing is cut off at exactly 90 degrees to ensure a proper sealing. It is recommended to use the tubing cutter included in the Liquid Handling Set.

The QSoft data file is very large and hard to operate with usual data handling programs.

A very long measurement (several hours and longer) with high time-resolution can easily make the QSoft data file size exceed 1 MB. Solutions:

- Use the Condense function, in QSoft "File" menu.



See chapter "QSoft 401 / Condense a measurement" for more details.

b) For future long measurements the amount of data can be kept smaller by moving the pin towards "Low noise" in the "Resonance optimization window".

9 Consumables & Accessories

Liquid Handling

<i>Cat #</i>	<i>Description</i>
QLH 401	Liquid Handling Set, incl. Teflon® tubing, ferrules, perifits, and nuts, o-rings and gaskets
QCS 005	Tubing PTFE 1/16" OD x 0.75 mm ID, 10m
QCS 001	O-rings, standard, for Flow Module QFM 401 (Viton® 4 pcs)
QCS 002	O-rings, standard for QFM 401 (Viton® 20 pieces)
QCS 019	O-rings, standard for QWM, QEM, QOM, QHM, QELM (Viton® 4 pcs)
QCS 017	O-rings, highly resistant for QFM 401 (Kalrez® 4 pcs)
QCS 023	O-rings, highly resistant for QWM, QEM, QOM, QHM, QELM (Kalrez® 4 pcs)
QCS 024	O-ring kit for QEM, 2 sets (12x1 mm 2pcs, 1.15x1 mm 4 pcs, 1.78x1 mm 2 pcs)
QCS 011	Sealing gasket for QFM 401 (Viton® 4 pcs)
QCS 018	Sealing gasket, highly resistant for QFM 401 (Kalrez® 4 pcs)
QCS 027	Sealing kit for QELM (gasket, o-rings: 12x1mm, 14x1mm, 5x1mm 2pcs, 1.15x1mm 4pcs)
QCS 006	Tygon tubing for Ismatec Reglo Digital / Reglo Analog
QCS 007	Tygon tubing for Ismatec IPC-N4
QCS 012	Ferrules (Teflon®, 30 pcs to connect tubing to black nuts)
QCS 013	Nuts, Black (Tubing holder screw, 12 pcs)
QCS 014	Perifits (Connectors to pump tubing, 4 pcs)
QCS 020	Sapphire glass for QWM 401
QCS 025	Gore® Membrane 12.5x21.5 mm for QHM 401 (1 pcs)
QCS 026	Reference electrode plastic screw for QEM (1 pcs)

Accessories

QCLH 301	Teflon cleaning holder for 5 sensor crystals
----------	--

For price and delivery information, please contact your local provider or Q-Sense. Contact details are found in Chapter "Support and Service".

10 Materials Guide

- All metal parts contacting sample fluids are made of **Titanium**, grade 2.
- Tubing is made of **Teflon**.
- Standard o-rings are made of A-type **Viton®**.
- Standard flow module sealing gaskets are made of A-Type **Viton®**.
- Highly resistant o-rings are made of **Kalrez® 6375**.
- Highly resistant sealing gaskets are made of **Kalrez® 6375**.

Common chemicals:

Chemical	Viton	Teflon	Chemraz	Kalrez
Ethanol	G	E	E	E
Hellmanex II 2%	E	E	E	E
Hexane	F	E	X	E
Toluene	X	E	E	E
NH ₄ O ₄ 30%	F	E	E	E
H ₂ O ₂ 30%	G	E	E	E
Dimethyl sulfoxide (DMSO)	X	E	E	E
Dimethylformamide (DMF)	X	E	E	E

For other media, please check a more extensive chemical compatibility guide under the user pages on our website www.q-sense.com.

11 Support and Service

If you need support on your Q-Sense product, please follow this process:

1. Check the Chapter "Troubleshooting" if your problem is mentioned here.
2. Contact your local Q-Sense provider, or
3. Contact Q-Sense directly:



send an e-mail to support@q-sense.com



call +46 31 769 7690 (headquarters in Sweden, time zone: GMT+1)



fax +46 31 69 80 40 (headquarters in Sweden, time zone: GMT+1)



call +1 (877) 773 6730 (US office, MD, time zone: EST)



fax +1 (866) 415 8164 (US office, MD, time zone: EST)

For updated contact details of your local provider, please go to our website www.q-sense.com and click on "Contact".

If you think your Q-Sense product needs service, please use the same contact information as above. Service of malfunctioning instruments during the limited warranty period is free of charge. When this warranty period has ceased, Q-Sense will charge a cost for the service, unless a Service agreement is written and paid for.

12 Technical Specifications E4

Operating conditions

The instrument is intended for indoor operation in a laboratory environment. For optimal measurements the ambient temperature has to be in the range 18 to 25°C and stable within 2°C. Do not operate at ambient temperatures below 5°C and above 30°C.

Electrical Data QE401

Rated supply voltages	100 / 115-120 / 220 / 230-240 V AC 50-60 Hz
Power, max	The power supply should be properly grounded. 120 VA
Fuse rating	T800 mA 250 V (at 220 / 230-240 V) T1.6 AL 250 V (at 100 / 115-120 V)

Software

PC requirements	USB 2.0, Windows 2000, XP
Input data, analysis software	Multiple frequency and dissipation data
Output data, analysis software	Modelled values of viscosity, elasticity, thickness and kinetic constants.
Import/export	Excel, BMP, JPG, WMF etc.

Sensors and sample handling system

Volume above each sensor	~ 40 µl using Q-Sense Flow Module for 5 MHz crystals
Minimum sample volume	~ 300 µl
Working temperature	15 to 45 °C, controlled via the software, stability ± 0.02 K _a
Flow rates	0-1 ml/min
Sensor crystals ^b	5 MHz, 14 mm diameter, polished, AT-cut, gold electrodes
Max load ^c	~ 0.1 mg/cm ²
Active area of sensor crystal	~ 0.2 cm ²

Frequency and dissipation characteristics

Frequency range	1-70 MHz (up to the 13th overtone, 65 MHz for a 5 MHz crystal)
Maximum time resolution, 1 sensor, 1 frequency	~ 100 data points per second
Maximum mass sensitivity in liquid ^d	~ 0.5 ng/cm ² (5 pg/mm ²)
Normal mass sensitivity in liquid ^e	~ 1.8 ng/cm ² (18 pg/mm ²)
Maximum dissipation sensitivity in liquid ^d	~ 0.04 x 10 ⁻⁶
Normal dissipation sensitivity in liquid ^e	~ 0.1 x 10 ⁻⁶

Dimensions	Height (cm)	Width (cm)	Depth (cm)	Weight (kg)
Electronics unit	18	36	21	9
Chamber platform	12	23	34	8

^a The ambient temperature (i.e. the temperature of the sample solutions outside the chamber) should preferably be within +/- 2K from the working temperature.

^b Several other sensor materials are available, for example, SiO₂, Titanium, Stainless steel, Polystyrene to mention a few.
^c Depends on the resonant frequency of the sensor crystal, and the density and the viscoelastic properties of the deposited film. Values given here are only approximate and applicable for a 5 MHz sensor crystal with a polystyrene adlayer.

^d Data from 1 sensor in single frequency mode. 1 data point is collected every 5 seconds. The Sauerbrey relation is assumed to be valid.

^e Data from all y66234 sensors in multiple frequency modes (3 harmonics) are collected within 1 second. The Sauerbrey relation is assumed to be valid.

Index

- A -

Abbreviations 5
 Accessories 54
 Acquisition menu 36, 41
 Acquisition software 9, 10
 Acronyms 5
 Analyzing software 9
 Assembly
 E4 system 24
 AutoController 36

- B -

Baseline 27
 Blow-drying 23

- C -

Cables 10
 Cautions 6
 Center frequency 37
 Chamber Platform 9, 20
 Chemical compatibility 26
 Cleaning
 cover 14
 ellipsometry module 34
 window module 30
 Cleaning procedures 27
 Condensing a data file 43
 Connecting the instrument together 10
 Contact info 56
 Conventions 5

- D -

D values 27
 Data acquisition 26
 DEAE 46
 Decay 37
 amplification 37
 average 37
 length 37
 sample rate 37
 Degassing 19
 Demounting the flow module 27

Dextran 46
 Dimensions 57
 Drift 27
 Drive
 amplitude 37
 time 37

- E -

Earth ground 8
 ELECTRICAL SHOCK 7
 Electrochemistry 29
 Electrochemistry module 9
 Electronics unit 9, 10
 Ellipsometry 31
 Ellipsometry module 9
 Environmental Aspects 10
 External pump 9

- F -

F&D panel 41
 F&D values 41
 absolute 27
 Features 5
 Ferrule 23
 Find all 37
 Find specific 37
 Flow chart
 measurement 15
 Flow mode
 continuous 20, 26
 stop- 20
 Flow module 9, 20, 23
 dismounting of 27
 function of 20
 order of 24
 sealer sheet 27
 working with 20, 25
 Frequency range 37, 57
 Front panel 20
 Fundamental resonance tone 27
 Fuses 57

- H -

Humidity Module 9, 34

- I -

Initialize 12

- K -

Kalrez 55

- M -

Materials 55

Measurement 26
 condensing a 43
 procedure 26
 terminating a 43

Measurement set-up
 typical 20

Measurements
 optimizing 26, 57

Microscopy 29

- N -

Noise levels 27

Notes 6

Notes panel 41

Nut 23

- O -

Open Module 9, 35

O-ring
 removal of 22, 27

O-rings 55

Overview of measurement procedure 15

- P -

Packaging 7, 10

PC 10

Power 10, 57

Power button 12

Pump 23

- Q -

QAutoController 36

QCP 401 20

QELM 401 31
QEM 401 29
QHM 401 34
QOM 401 35
QSoft 401 9, 10
QSoft401 10
 location 12
QTools 401 9
Quartz 16
QWM 401 29

- R -

Resonances 37
Rinsing speed 26

- S -

Safety precautions 7
Salt solution RH values 35
Sample liquid 26
 degassing of 19
Sample liquids 8
 preparation of 19
Sensitivity
 D 57
 f 57
 mass 57
Sensor crystal 9
 active area 16, 57
 cleaning 17
 description of 16
 handling of 16, 23
 load 17
 mounting of 22
 position 22
 verification of function 27
Service 56
Setpoint temperature 12
Setup measurement 36
Solvent properties 19
Stitching data files 44
Storage 7
Support 56
Sweep 37
System Overview 9

- T -

Teflon 23, 55

Teflon slits 22
Telephone numbers 56
Temperature 7
 control 36, 39, 41
 panel 41
 stabilization of samples 19
 working 19
Titanium 55
Transport 7
Tubing 23, 55
 connection of 23
Tweezers 16

- U -

USB 10, 57

- V -

Ventilation 7
Verification of functioning crystal 27
Viton 55
Voltage rates 7, 10, 57
Volumes
 chamber void 57
 sample 57

- W -

Warnings 6
Window Module 29