

## The electro-mechanical behaviour of flexural ultrasonic transducers

Steve Dixon, Lei Kang, Michael Ginestier, Christopher Wells, George Rowlands, and Andrew Feeney

Citation: *Appl. Phys. Lett.* **110**, 223502 (2017); doi: 10.1063/1.4984239

View online: <http://dx.doi.org/10.1063/1.4984239>

View Table of Contents: <http://aip.scitation.org/toc/apl/110/22>

Published by the [American Institute of Physics](#)

---

---



**FIND THE NEEDLE IN THE  
HIRING HAYSTACK**

POST JOBS AND REACH THOUSANDS OF  
QUALIFIED SCIENTISTS EACH MONTH.

PHYSICS TODAY | JOBS  
[WWW.PHYSICSTODAY.ORG/JOBS](http://WWW.PHYSICSTODAY.ORG/JOBS)

## The electro-mechanical behaviour of flexural ultrasonic transducers

Steve Dixon,<sup>a)</sup> Lei Kang, Michael Ginestier, Christopher Wells, George Rowlands, and Andrew Feeney

University of Warwick, Department of Physics, Coventry CV4 7AL United Kingdom

(Received 7 April 2017; accepted 15 May 2017; published online 30 May 2017)

Flexural ultrasonic transducers are capable of high electro-mechanical coupling efficiencies for the generation or detection of ultrasound in fluids. They are the most common type of ultrasonic sensor, commonly used in parking sensors, because the devices are efficient, robust, and inexpensive. The simplest design consists of a piezoelectric disc, bonded to the inner surface of a metal cap, the face of which provides a vibrating membrane for the generation or detection of ultrasonic waves in fluids. Experimental measurements demonstrate that during the excitation of the piezoelectric element by an electrical voltage, there are three characteristic regions, where the frequency of the emitted ultrasonic wave changes during the excitation, steady-state, and the final decay process. A simple mechanical analogue model is capable of describing this behaviour. © 2017 Author(s). All article content, except where otherwise noted, is licensed under a Creative Commons Attribution (CC BY) license (<http://creativecommons.org/licenses/by/4.0/>). [<http://dx.doi.org/10.1063/1.4984239>]

Flexural ultrasonic transducers (FUTs) are ideally suited to generate or detect ultrasonic waves in fluids. They operate by a bending or flexing action of a metal membrane on which a piezoelectric element is bonded. The coupled system of the membrane and piezoelectric element vibrates at one or more resonant frequencies, and the piezoelectric used is usually so thin that the response of the total system is dominated by the resonant properties of the membrane alone. Commercial FUTs consist of an aluminium cap, in which the piezoelectric material is bonded to the inner surface of the cap as shown in Fig. 1. The cap forms both the vibrating membrane for the device and provides a protective enclosure for the piezoelectric element.

In medical ultrasound or non-destructive testing, piezoelectric sensors are typically used in a through thickness resonance mode of vibration, where the thickness of the piezoelectric defines the dominant frequency of the ultrasonic transducer.<sup>1</sup>

Using this type of thickness resonant mode transducer to generate ultrasonic waves in a fluid is straightforward, despite the significant acoustic impedance mismatch. It is more difficult to obtain high detection sensitivity, due to the large mismatch between the acoustic impedance of the transducer and the fluid. The standard strategy to reduce this impedance mismatch is to use a quarter wave matching layer,<sup>2</sup> but even then, the improvement in coupling efficiency is limited. Some transducers also operate via a radial mode resonant frequency.<sup>3</sup> This can have the advantage that a lower frequency of operation can be achieved using a thinner piezoelectric element, which requires a lower voltage to achieve a suitably high electric field within the material.

FUTs operate on a different principle to through thickness or radial mode, piezoelectric resonance mode based sensors. A circular flexural transducer operates through the bending of a compliant membrane, whose compliance can be

increased by increasing the diameter of the membrane or decreasing the thickness of the membrane, or by changing the membrane material. The membrane is also the housing of the sensor and so usually a suitably robust material would be used for the application, such as titanium or coated aluminium. Flexural transducers have a number of resonant modes that can be usefully exploited, some of which are axisymmetric, which are generally more useful.<sup>4-6</sup>

Despite the widespread use of FUTs in parking sensors, ultrasonic alarms, and a range of other applications, there is relatively little published research on their design and operation. In this paper, we describe the general response of these ultrasonic sensors, focusing on readily available sensors operating at 40 kHz, although the findings also apply to sensors operating at higher frequencies. We describe an efficient and simple way to accurately measure the resonant frequencies of flexural sensors, and explain the effects of driving these sensors at frequencies away from their resonant frequency. These findings are essential considerations when looking at applications of the sensors.

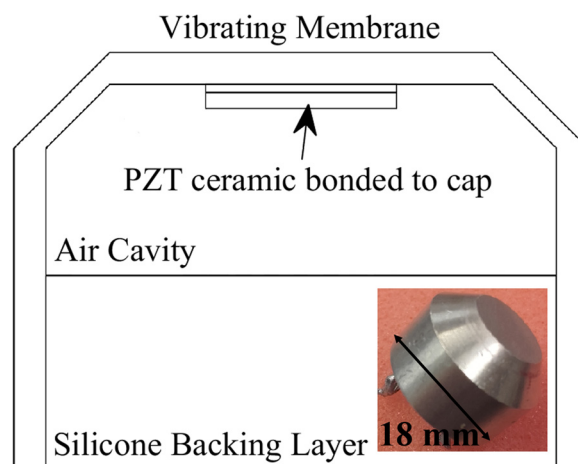

FIG. 1. Schematic diagram, not to scale, of the FUT, and the real device (inset). The piezoelectric ceramic disc is usually thinner than the membrane.

<sup>a)</sup>Email: s.m.dixon@warwick.ac.uk

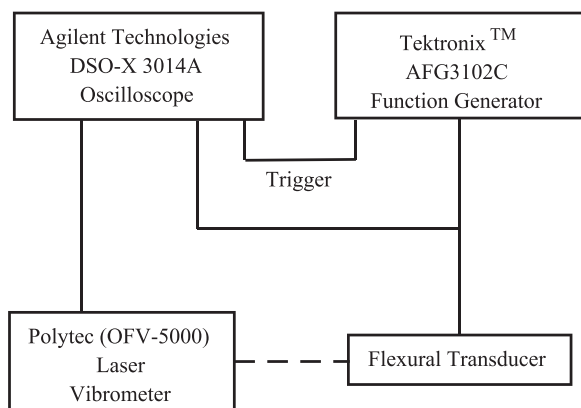

FIG. 2. Experimental set-up using a function generator to drive a flexural ultrasonic transducer and an oscilloscope to measure the voltage across the FUT’s piezoelectric contacts. The laser Doppler vibrometer is shown to demonstrate how velocity measurement can be incorporated into the set-up.

Approaches to accurately measuring the resonant frequency of flexural ultrasonic sensors include the use of impedance analysers, measuring a frequency swept response of a sensor using secondary calibrated ultrasonic generators or detectors, or using wideband excitation of a FUT and performing Fourier analysis of its response.<sup>5</sup> Consider the simple experimental set-up shown in Fig. 2. A function generator is used to drive a FUT using a few cycles of a particular frequency and voltage level. An oscilloscope attached to the function generator will measure the output of the function generator and simultaneously the response of the piezoelectric element within the FUT. A laser Doppler vibrometer can be easily included in the set-up as shown to enable the measurement of the vibration velocity.

The signals shown in Fig. 3 are clearly dominated by the relatively large amplitude of the driving voltage. If we look carefully at the displacement or electrical signal from the FUT after the drive signal has been switched off, the transducer vibrates at its resonant frequency almost immediately, decaying exponentially. This is displayed in the inset of Fig. 3. This measurement of the ring-down frequency can be used to tune the drive voltage frequency to the FUT resonance if desired.

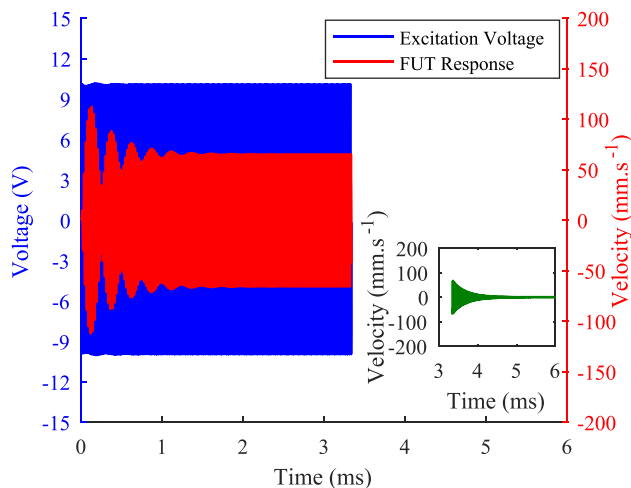

FIG. 3. Voltage signal measured by the oscilloscope for a 45 kHz drive frequency (main), and the FUT ringing down at its resonant frequency after the drive signal is switched off (inset).

There is a discontinuity in the phase of the signal measured on the oscilloscope when the drive voltage is switched off. The point at which this phase discontinuity in the voltage signal occurs will become stable when the system reaches a steady-state condition, but it is dependent on both the amplitude and frequency of the drive voltage. The reason for this is that there is a phase difference between the drive voltage and the displacement of the FUT’s vibrating membrane, which is dependent on both the amplitude and frequency of the driving voltage.

When a FUT is driven at a frequency close to resonance, it will give a high output level of ultrasonic pressure waves. It does however take a number of cycles of the driving voltage to reach a steady-state condition, where the amplitude of vibration of the FUT membrane does not change and it oscillates at the driving voltage frequency, with a phase difference between the drive voltage and transducer displacement. A plot of FUT membrane vibration amplitude is shown in Fig. 4, for a range of frequencies around the FUT’s nominal 40 kHz resonance mode, using a fixed amplitude voltage drive of 20 V peak-peak. In this paper, the FUT membrane displacement is always measured using a Polytec point measurement vibrometer, directed at the centre of the membrane.

When the FUT is initially activated by the driving voltage, the frequency of the vibration is in fact ill-defined, as the displacement of the membrane is not sinusoidal. By measuring the change in the peak and trough positions of the membrane displacement signal or the zero crossing points, we are able to obtain an effective instantaneous frequency of vibration measurement and measure when the system reaches steady-state. Driving the FUT at the same frequencies as shown in Fig. 4, and plotting an effective frequency from zero crossing points of the displacement response of the sensor, yields the result shown in Fig. 5.

At values close to the resonant frequency of the FUT, the effective instantaneous frequency of vibration of the membrane smoothly converges towards the drive voltage frequency. At drive voltage frequencies further from the resonant frequency, the effective frequency of vibration appears to oscillate around and then converge to the drive frequency. In all cases, where there has been some vibration of the membrane, when the drive voltage is switched off, the

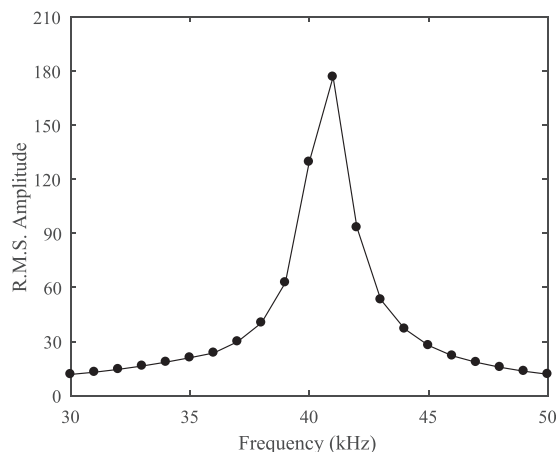

FIG. 4. Amplitude response of the centre of the FUT membrane for a constant amplitude drive voltage over a range of frequencies close to resonance.

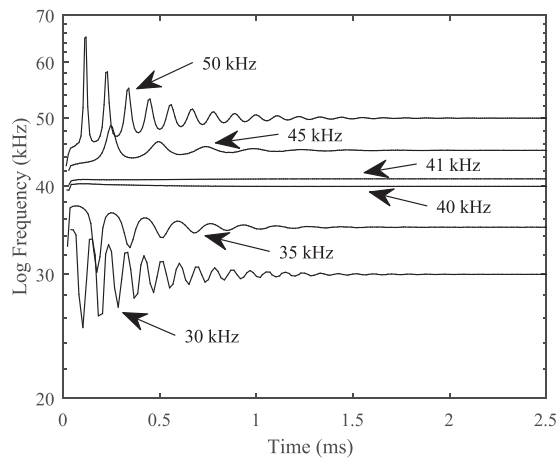

FIG. 5. Effective frequency response of the FUT for different excitation frequencies.

vibration frequency instantly becomes the resonant frequency of the membrane, and its amplitude of vibration decays exponentially.

This system can be modelled as a mechanical analogue system, using a spring in parallel with a dashpot that is attached to a mass as shown in Fig. 6. The mass represents the effective mass of the vibrating membrane, the spring represents the effective elasticity of the vibrating membrane, and the dashpot represents the damping of the system, which will be due to loading from the fluid surrounding the membrane and other mechanical losses in the membrane system. Note that this approach does not give an accurate physical model of the FUT itself, as this would require something similar to finite element modelling.<sup>4</sup> It can however provide valuable insights, descriptions, and predictions into the mechanical response of the transducer.

There are three distinct regions in the experimental data that also arise in the mechanical analogue. The first stage is when the drive voltage is initially applied to the piezoelectric element when the membrane starts at rest, up until a point in time where the system reaches steady-state. In this first region, the equation of motion can be solved by treating the driving force as a Heaviside function convolved with a sinusoidal wave. The resultant equation of motion for this region is given as

$$M\ddot{x} + C\dot{x} + Kx = F \sin(\omega t) \cdot H(t_0 - t). \quad (1)$$

In this equation,  $t$  is the time,  $\omega$  is the driving frequency,  $F$  is the time-dependent force acting on the effective mass,  $M$  is the mass,  $x$  is the displacement,  $C$  is the damper coefficient, and  $K$  is the effective spring stiffness.

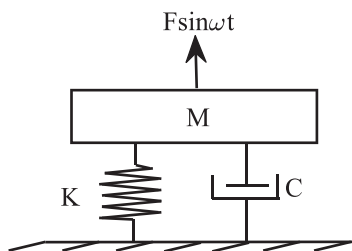

FIG. 6. Simple mechanical analogue of the FUT that is used to gain insights into the response of the transducer.

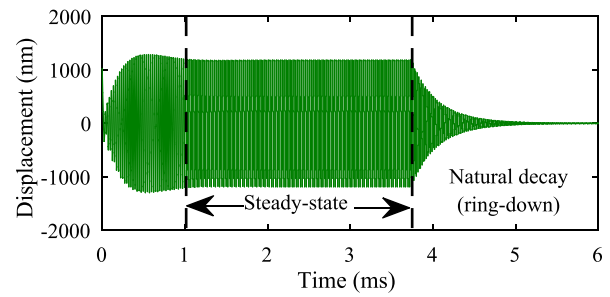

FIG. 7. Experimentally measured response of a FUT for a 40 kHz drive frequency, showing the three response regions.

The equation for the second region describes the mechanical analogue at steady-state, where the forcing function is a sine wave. In the final stage, the driving force to the mass is switched off ( $F = 0$ ), and the system oscillates at its resonance frequency, with decaying amplitude. The results for both these two final stages are standard results available in most undergraduate text books and are not reproduced here.<sup>7</sup> The vibrometer measured membrane amplitude from each of these regions is plotted in Fig. 7.

An alternative view of the system response is to consider the start of the drive voltage as a wideband source that excites the FUT at its resonant frequency, which will subsequently decay exponentially, whilst simultaneously the FUT is forced to vibrate at the driving voltage frequency. Fitting a model of a sum of an exponentially decaying sinusoidal wave at the resonant frequency and adding to it a sinusoidal wave at the drive voltage frequency yields an excellent fit to the experimental data for the range of conditions tested. In this fit, the initial amplitude and decay rate of the resonant frequency vibration, the amplitude of the driving voltage frequency, and the relative phase of the two signals are allowed to vary. The frequencies of each sinusoid are fixed for each measurement. The results for driving a FUT with a resonant frequency of 41 kHz at frequencies of 30, 40, and 45 kHz are shown in Fig. 8, together with fits to the data, in accordance with Eq. (2), where  $\theta$  is the drive signal phase,  $\omega_n$  is the FUT resonance frequency,  $\Phi$  is the resonance phase, and  $A$  and  $B$

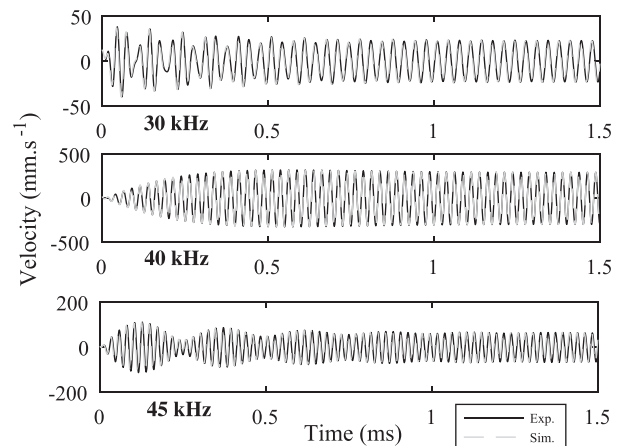

FIG. 8. Experimental data (black solid) for the initial stage response of the FUT with fitted simulation data (grey dash), assuming that the response consists of one decaying sinusoidal signal at resonance and a second sinusoidal signal at the drive frequency.

are the amplitudes of the drive and resonance signals, respectively.

$$x(t) = A \sin(2\pi\omega t - \theta) + B e^{-\frac{c}{2M}t} \sin(2\pi\omega_n t - \Phi). \quad (2)$$

The results show that the response of the transducer is consistent with the assumed response and the parameters obtained from the fits are all reasonable. The response of flexural ultrasonic transducers has been rigorously quantified in experimental measurements, modelled, and explained, and a straightforward method to directly measure the resonant frequency of the transducers has also been demonstrated. These findings will help tremendously in application designs for sensors of this type.

This research was funded by EPSRC Grant No. EP/N025393/1. The data from the results reported in these experiments are available at [http://www2.warwick.ac.uk/fac/sci/physics/research/ultra/research/APL\\_AF1.zip](http://www2.warwick.ac.uk/fac/sci/physics/research/ultra/research/APL_AF1.zip).

- <sup>1</sup>Q. Zhou, S. Lau, D. Wu, and K. K. Shung, *Prog. Mater. Sci.* **56**, 139 (2011).
- <sup>2</sup>A. J. Mulholland, N. Ramadas, R. L. O'Leary, A. Parr, G. Hayward, A. Troge, and R. A. Pethrick, *IMA J. Appl. Math.* **73**, 936 (2008).
- <sup>3</sup>V. K. Chillara, C. Pantea, and D. N. Sinha, *Appl. Phys. Lett.* **110**, 064101 (2017).
- <sup>4</sup>T. J. R. Eriksson, S. N. Ramadas, and S. M. Dixon, *Ultrasonics* **65**, 242 (2016).
- <sup>5</sup>T. J. Eriksson, M. Laws, L. Kang, Y. Fan, S. N. Ramadas, and S. Dixon, *Sensors* **16**, 1363 (2016).
- <sup>6</sup>R. Mitra, *IEEE T. Ultrason. Ferr.* **43**, 858 (1996).
- <sup>7</sup>W. T. Thomson and M. D. Dahleh, *Theory of Vibration with Applications*, 5th ed. (Pearson, 1997).