

# Heavy Flavour Physics at the LHC

Tim Gershon

University of Warwick and CERN

Lessons from the first phase of the LHC

DESY

27 September 2012

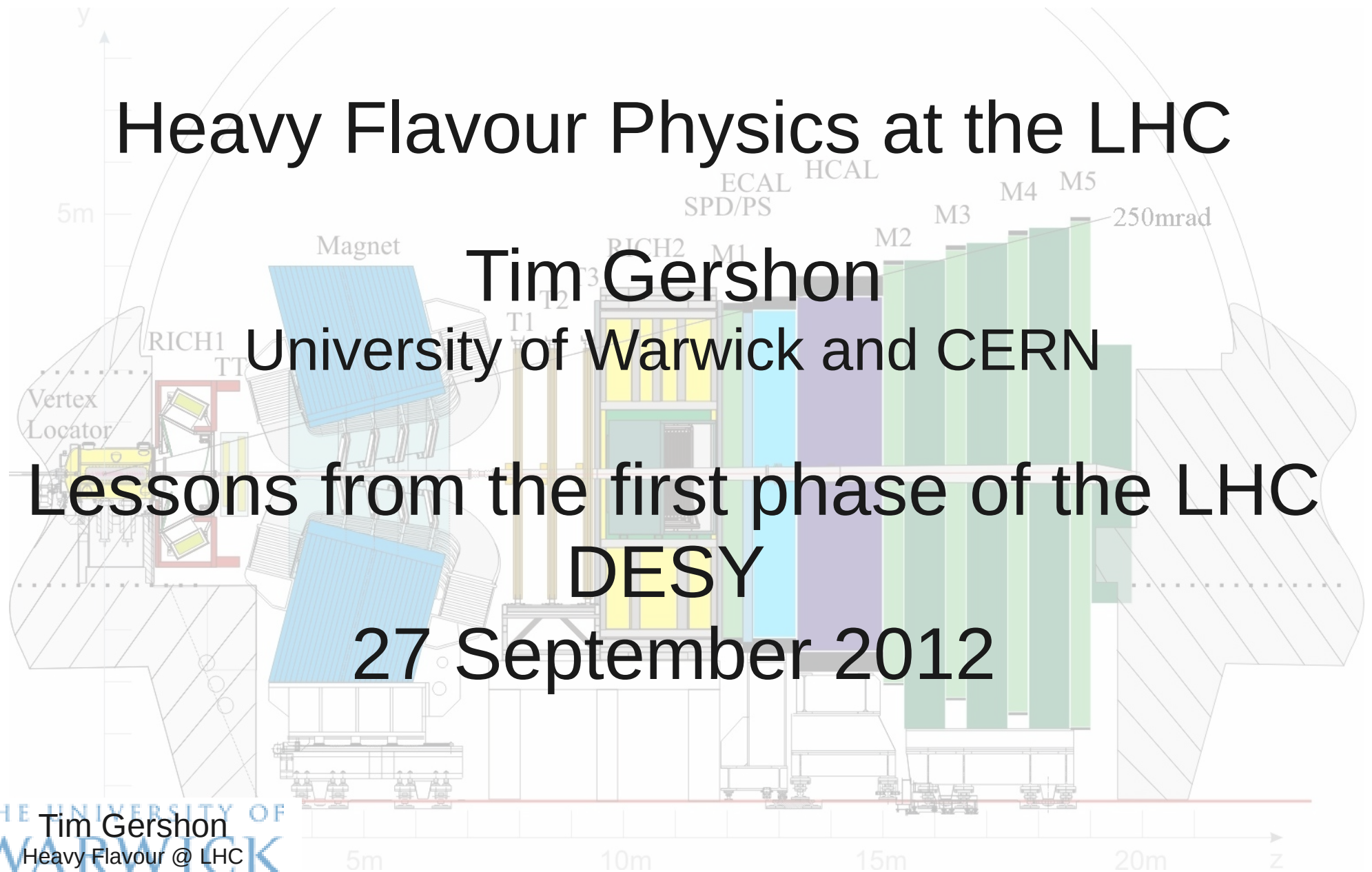

# Outline

- Heavy flavour production at the LHC
- The LHCb experiment
- Selected highlights of results in rare decays
- Selected highlights of results in CP violation
- The LHCb upgrade

# Flavour physics at hadron colliders

	$e^+e^- \rightarrow \Upsilon(4s) \rightarrow B\bar{B}$ PEP-II, KEK-B	$p\bar{p} \rightarrow b\bar{b}X$ ( $\sqrt{s} = 2$ TeV) TeVatron	$pp \rightarrow b\bar{b}X$ ( $\sqrt{s} = 14$ TeV) LHC
prod	1 nb	$\sim 100$ $\mu\text{b}$	$\sim 500$ $\mu\text{b}$
typ. $b\bar{b}$ rate	10 Hz	$\sim 100$ kHz	$\sim 500$ kHz
purity	$\sim 1/4$	$\sigma_{b\bar{b}}/\sigma_{inel} \approx 0.2\%$	$\sigma_{b\bar{b}}/\sigma_{inel} \approx 0.6\%$
pile-up	0	1.7	0.5-20
B content	$B^+B^-$ (50%), $B^0\bar{B}^0$ (50%)	$B^+$ (40%), $B^0$ (40%), $B_s$ (10%), $B_c$ ( $< 1\%$ ), b-baryons (10%)	
B boost	small, $\beta\gamma \sim 0.56$	large, decay vertices are displaced	
event structure	$BB$ pair alone	many particles non-associated to $b\bar{b}$	
prod. vertex	Not reconstructed	reconstructed with many tracks	
$B^0\bar{B}^0$ mixing	coherent	incoherent $\rightarrow$ flavour tagging dilution	

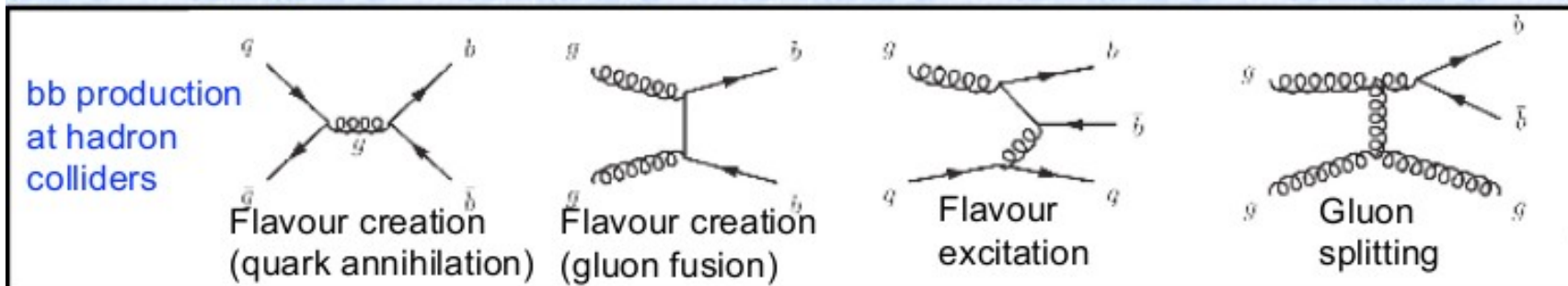

# Heavy flavour production @ ATLAS

“Measurement of the differential cross-sections of inclusive, prompt and non-prompt  $J/\psi$  production in proton-proton collisions at  $\sqrt{s} = 7$  TeV”  
 Nucl. Phys. B 850 (2011) 387

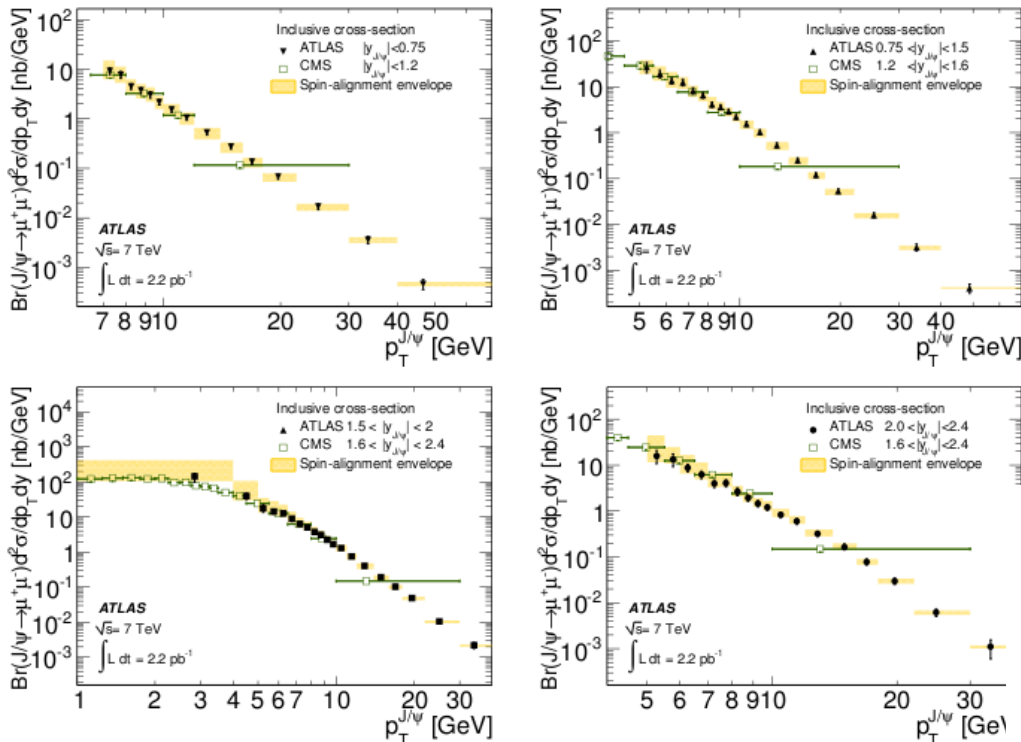

“Measurement of the b-hadron production cross section using decays to  $D^{*+} \mu^- X$  final states in pp collisions at  $\sqrt{s} = 7$  TeV with the ATLAS detector”  
 Nucl. Phys. B 864 (2012) 341

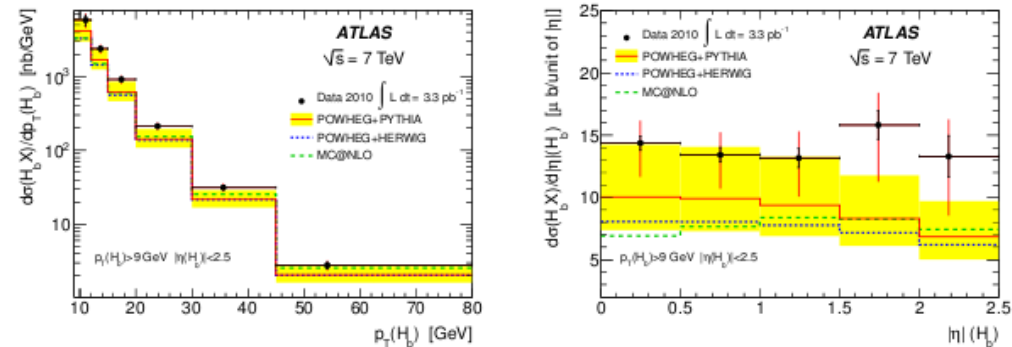

(a)

(b)

# Heavy flavour production @ CMS

“J/ψ and ψ(2S) production in pp collisions  
at  $\sqrt{s} = 7$  TeV”

J. High Energy Phys. 02 (2012) 011

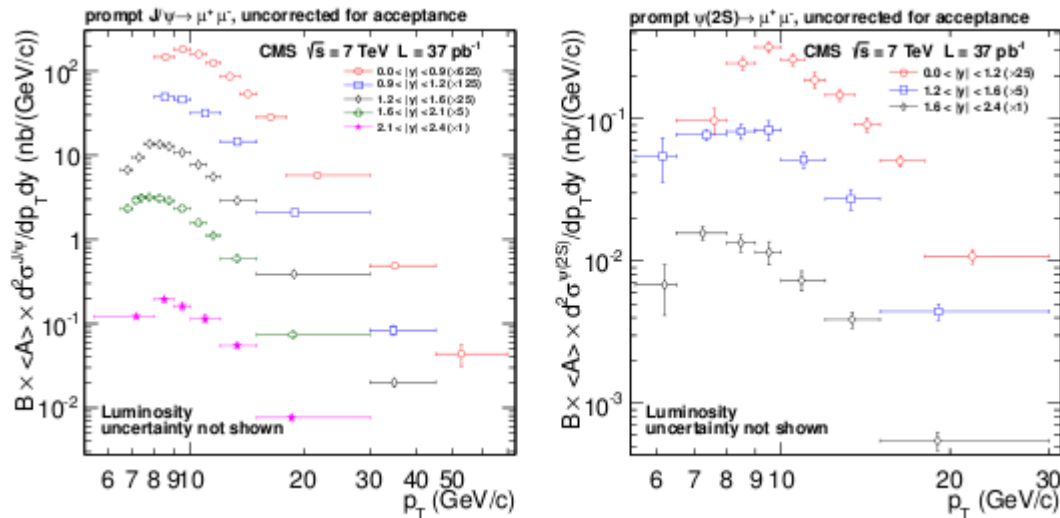

“Measurement of the cross section for  
production of b b-bar X, decaying to  
muons in pp collisions at  $\sqrt{s}=7$  TeV”

J. High Energy Phys. 06 (2012) 110

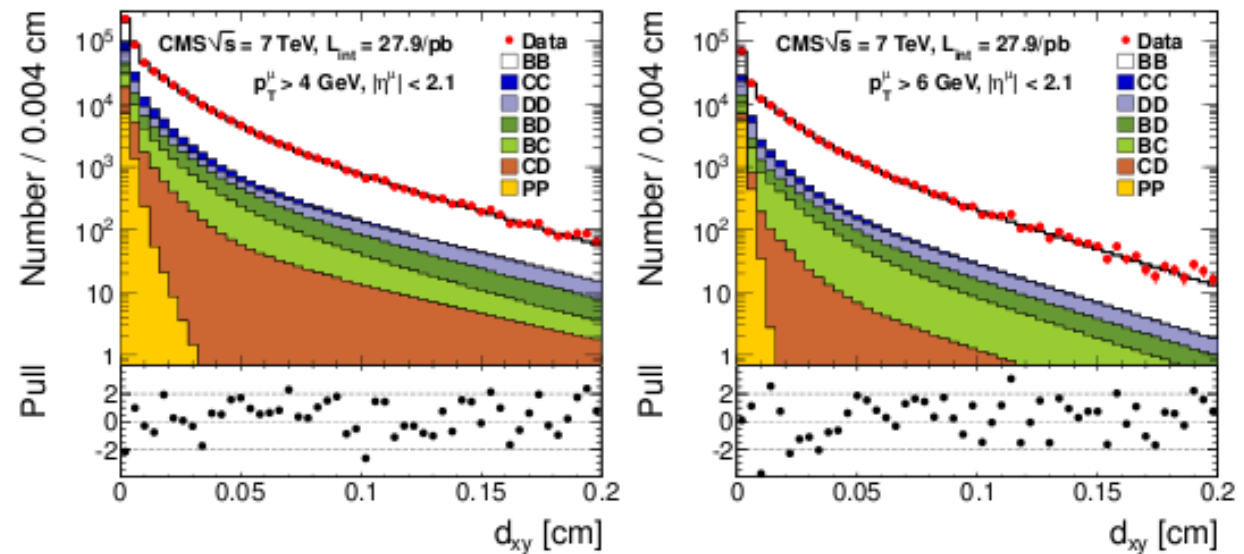



# Geometry

- In high energy collisions,  $b\bar{b}$  pairs produced predominantly in forward or backward directions
- LHCb is a forward spectrometer
  - a new concept for HEP experiments

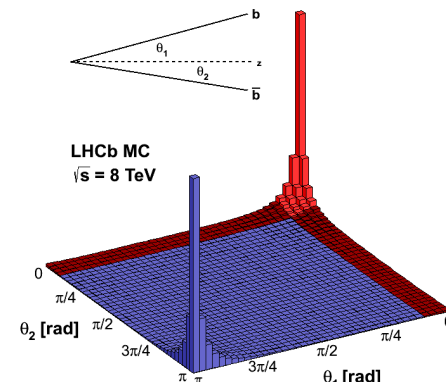

The LHCb Detector  
JINST 3 (2008) S08005

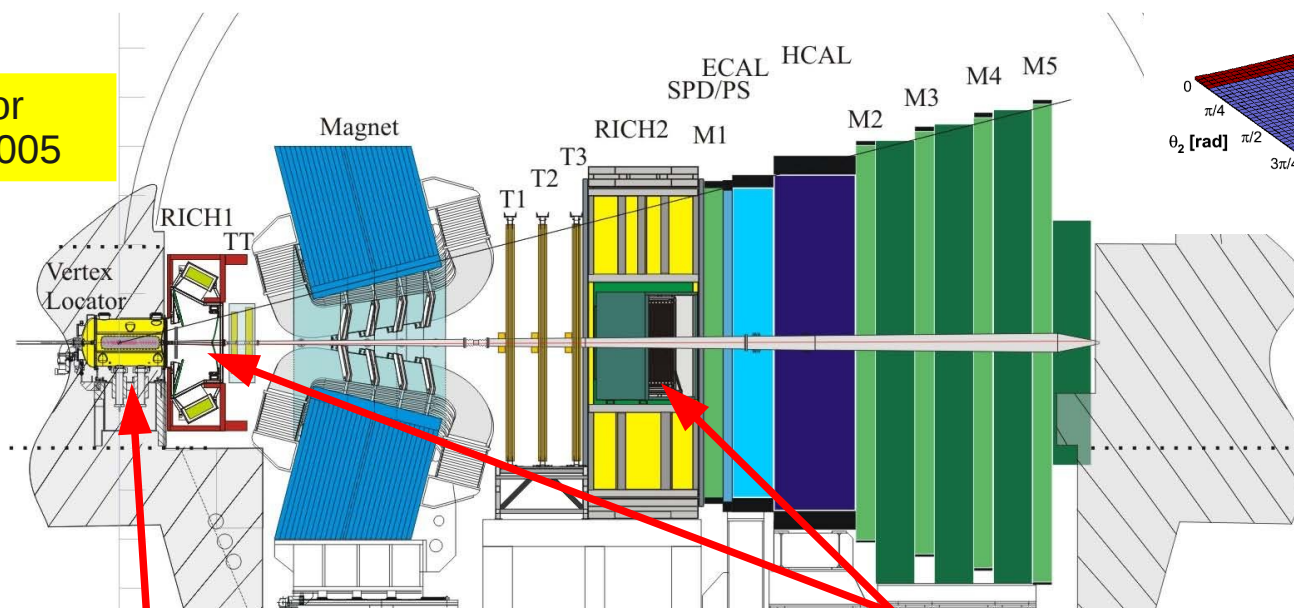

Precision primary and secondary vertex measurements

Excellent  $K/\pi$  separation capability

# VELO

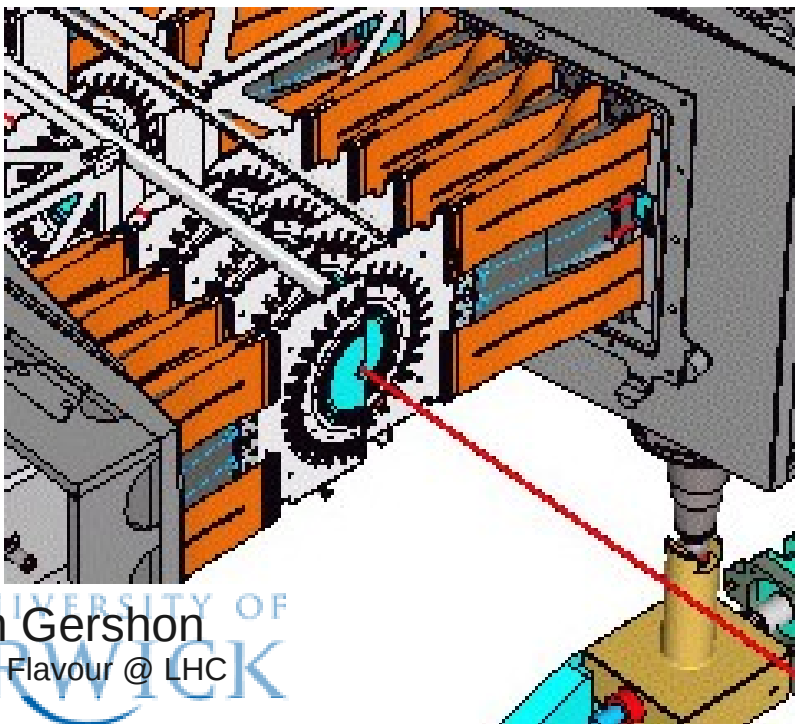

IP<sub>x</sub> Resolution Vs 1/p<sub>T</sub>

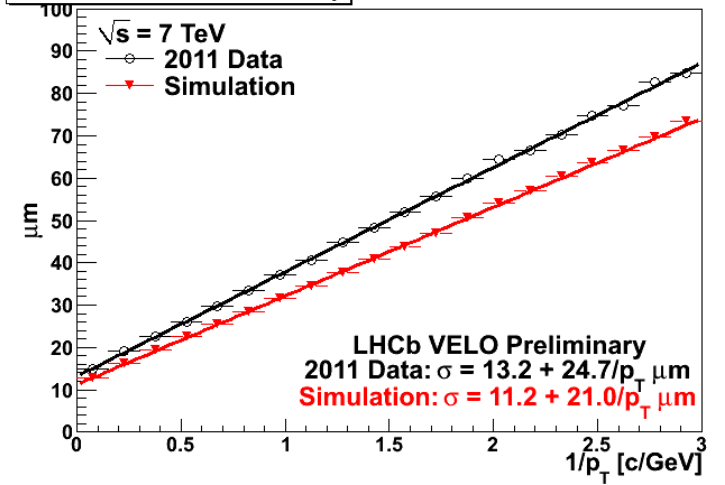

Material imaged used beam gas collisions

LHCb VELO Preliminary

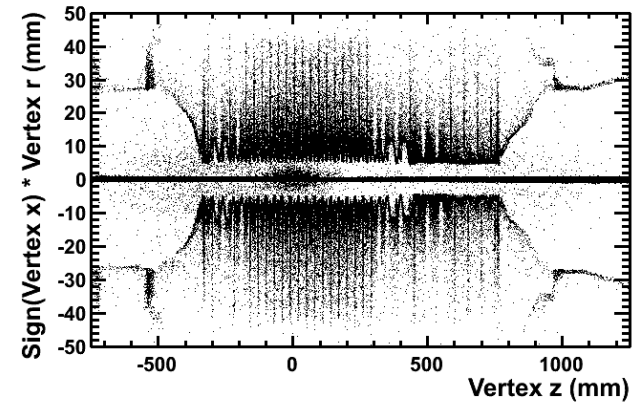

LHCb VELO Preliminary

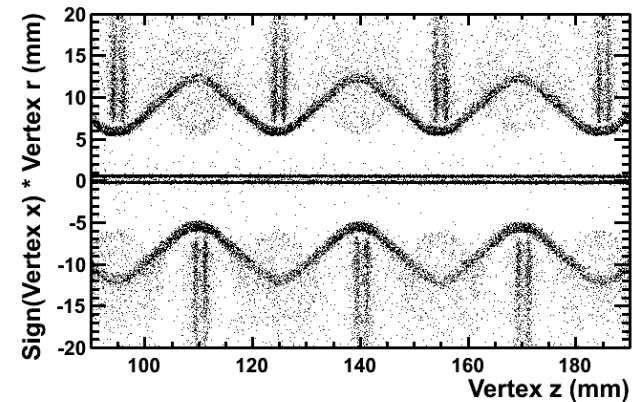



# RICH

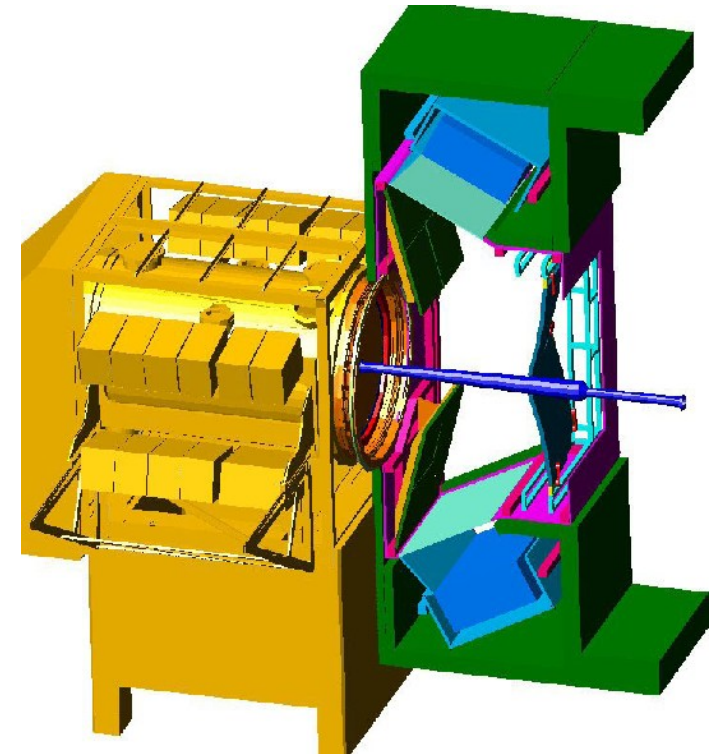
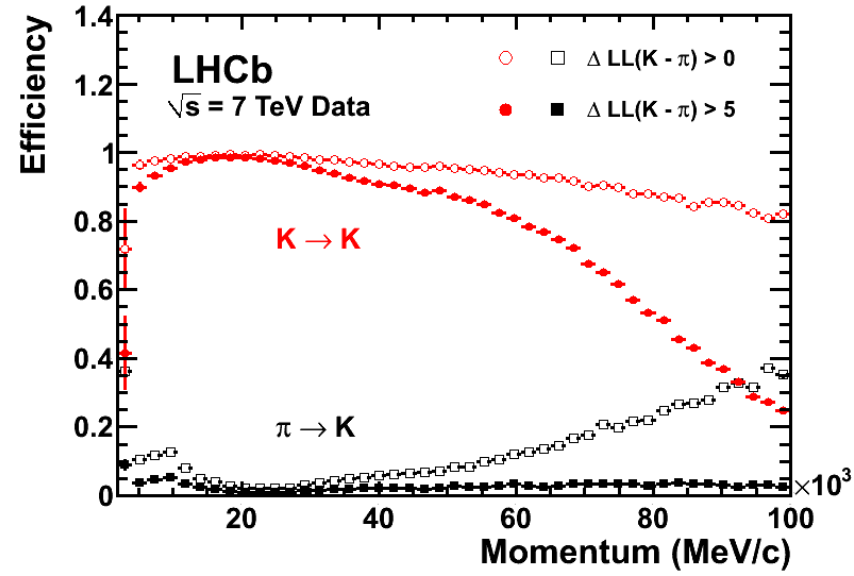
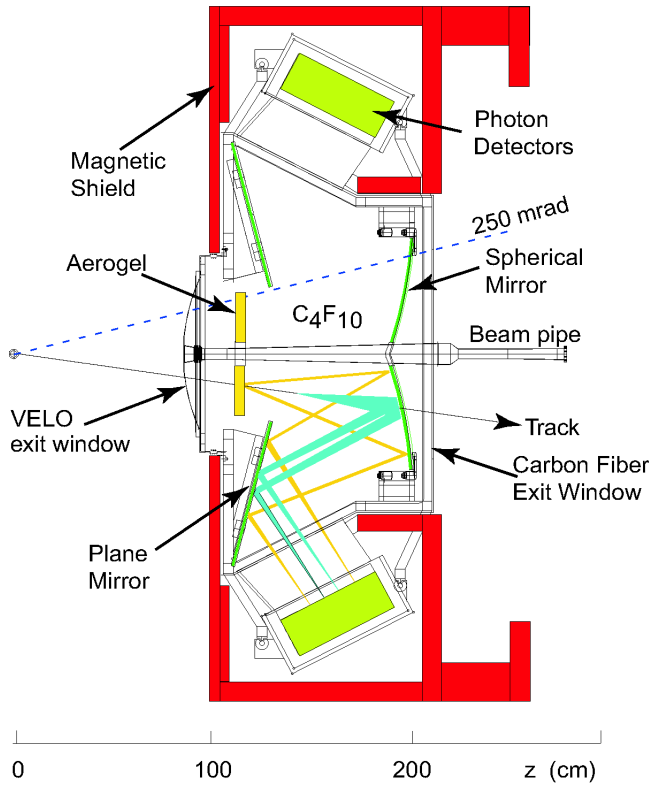



# The all important trigger

## Challenge is

- to efficiently select most interesting B decays
- while maintaining manageable data rates

## Main backgrounds

- “minimum bias” inelastic pp scattering
- other charm and beauty decays

## Handles

- high  $p_T$  signals (muons)
- displaced vertices

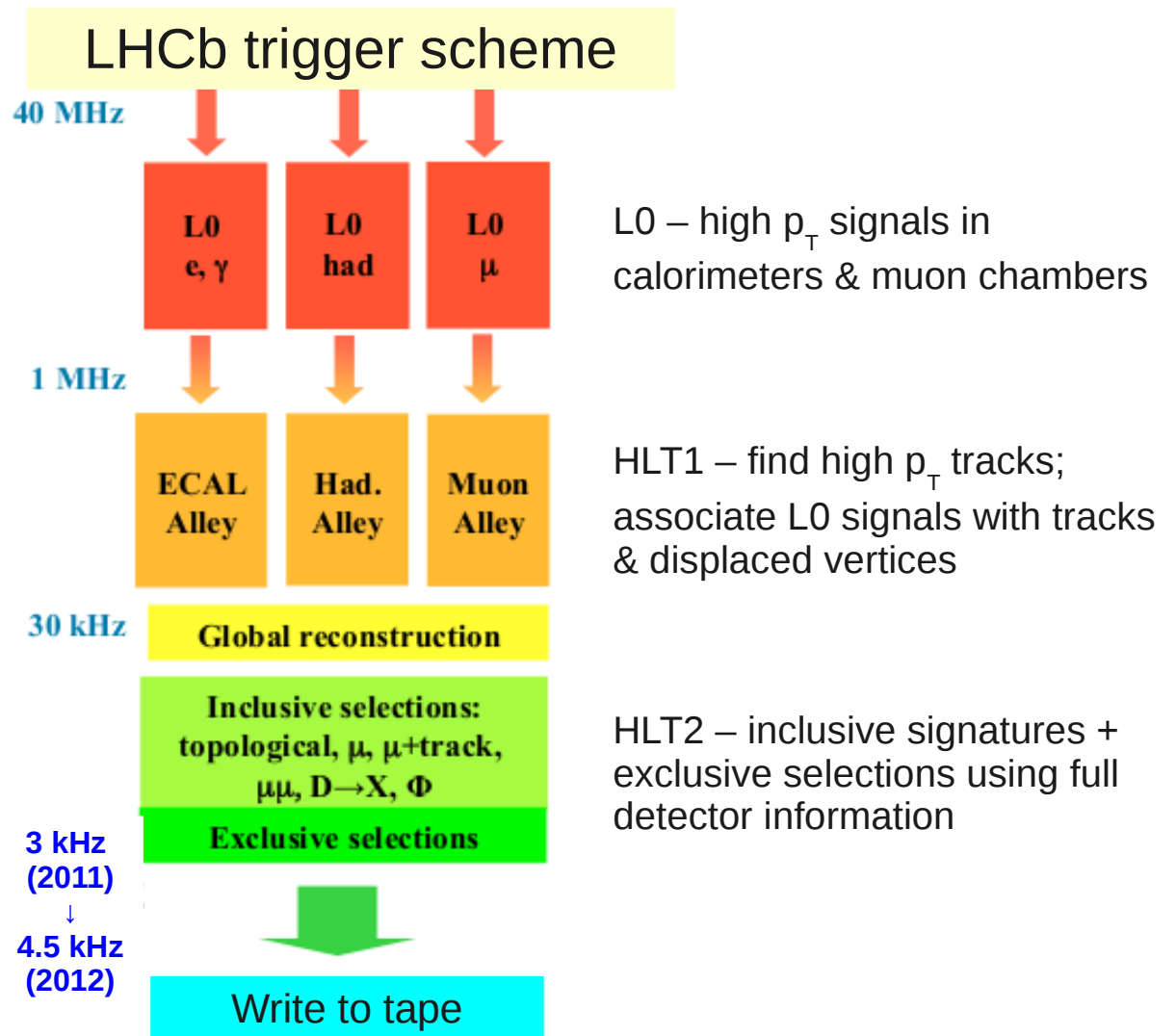

# Heavy flavour production @ LHCb

“Prompt charm production in pp collisions at  $\sqrt{s} = 7$  TeV”  
LHCb-CONF-2010-013

“Measurement of  $J/\psi$  production in pp collisions at  $\sqrt{s} = 7$  TeV”  
Eur. Phys. J. C 71 (2011) 1645

$D^0+c.c.$  cross-section

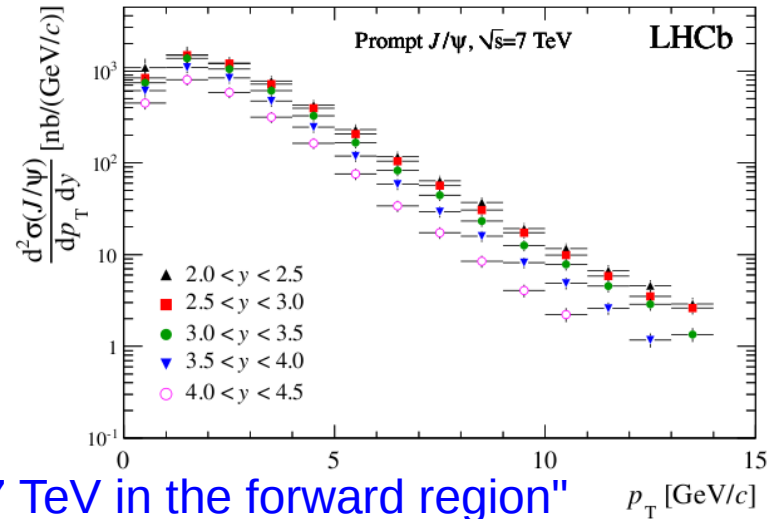
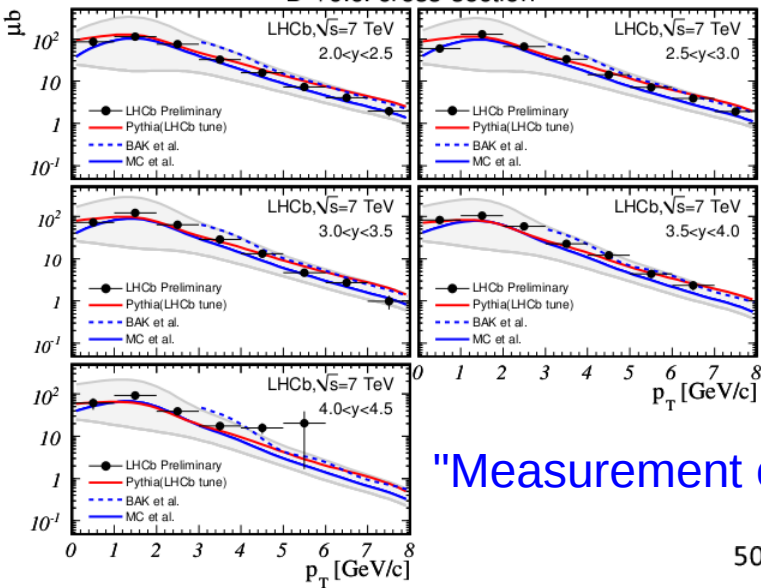

“Measurement of  $\sigma(pp \rightarrow b\bar{b}X)$  at  $\sqrt{s} = 7$  TeV in the forward region”  
Physics Letters B 694 (2010) 209

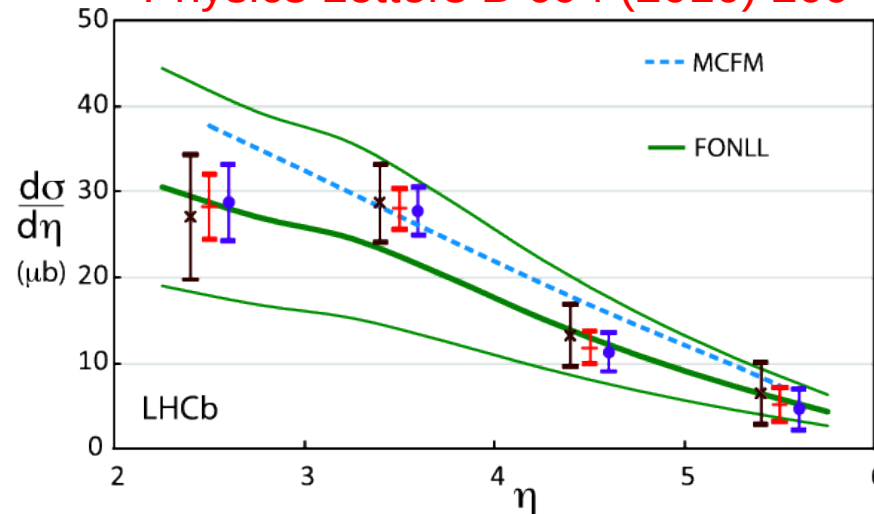

# Observations of new states

(no, not the Higgs)

“Observation of a New  $\chi_b$  State in Radiative Transitions to  $Y(1S)$  and  $Y(2S)$  at ATLAS”

Phys. Rev. Lett. 108 (2012) 152001

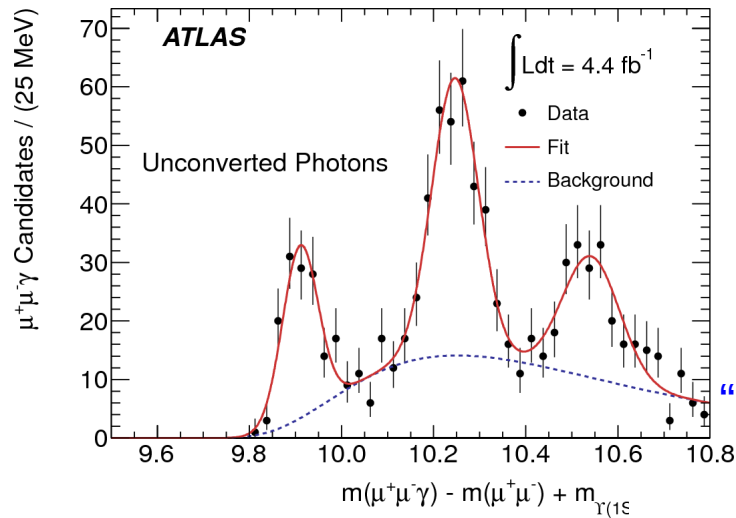

“Observation of excited  $\Lambda_b^0$  baryons”

arXiv:1205.3452

“Observation of a New  $\Xi_b$  Baryon”

Phys. Rev. Lett. 108 (2012) 252002

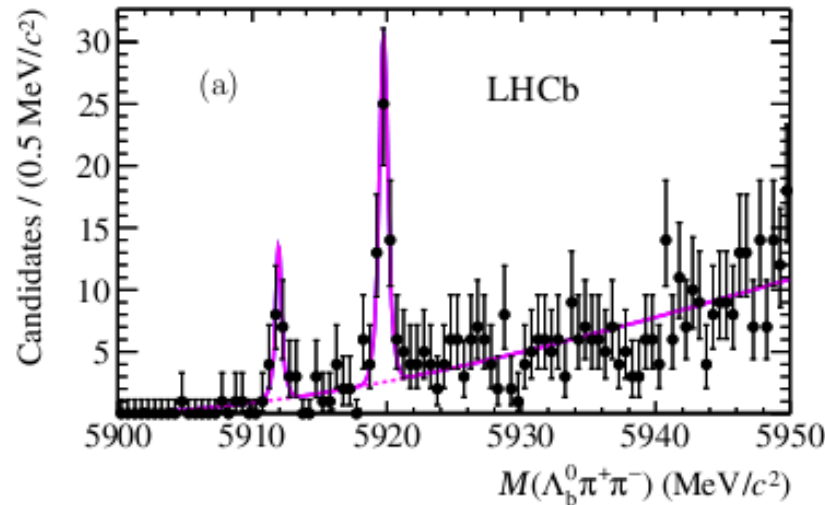
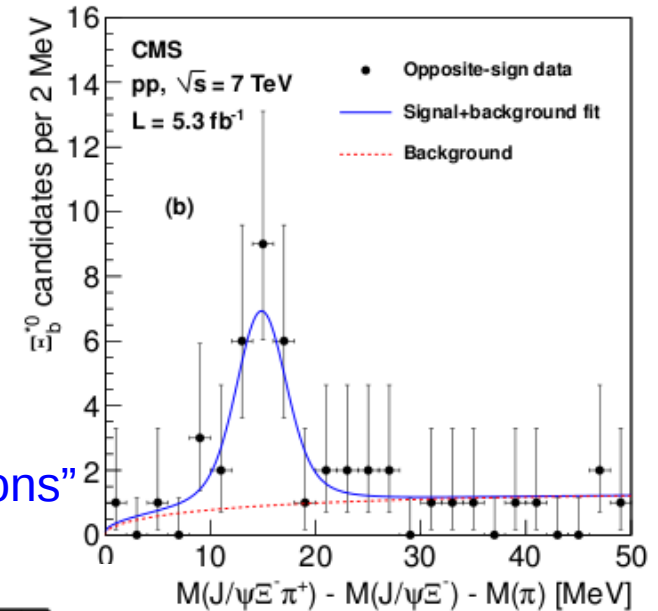

# The LHC





# LHC performance 2011

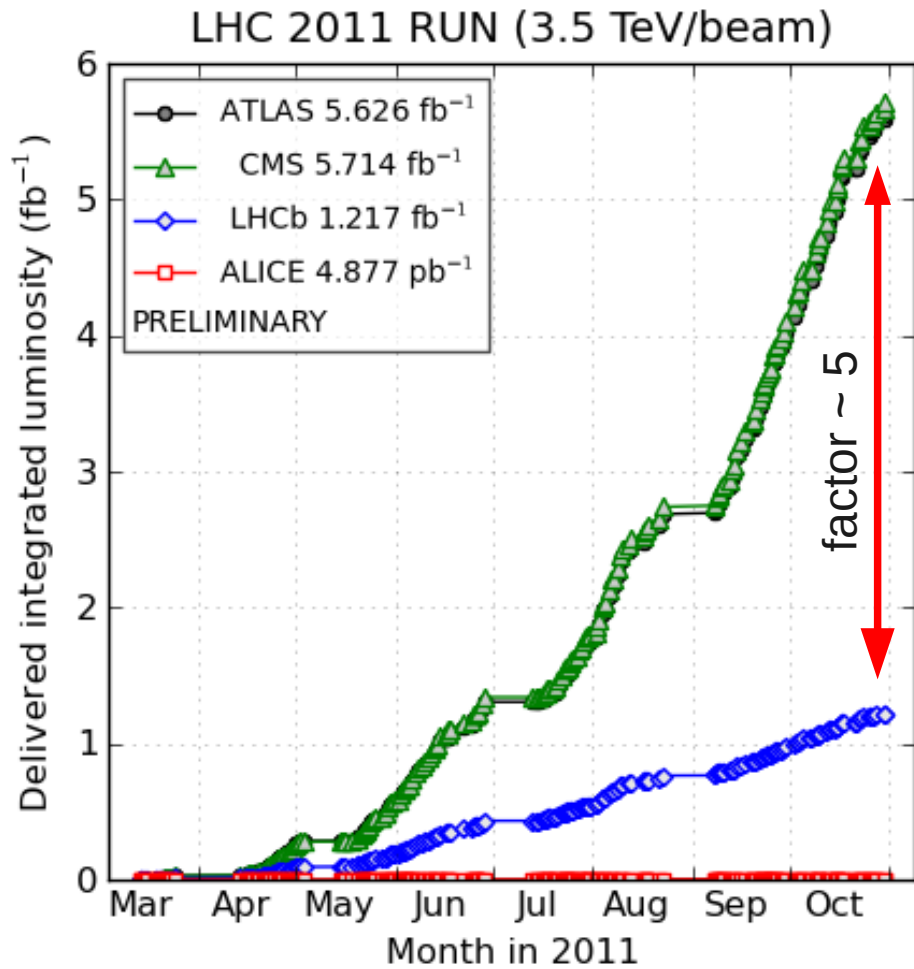

(generated 2011-12-01 19:35 including fill 2267)

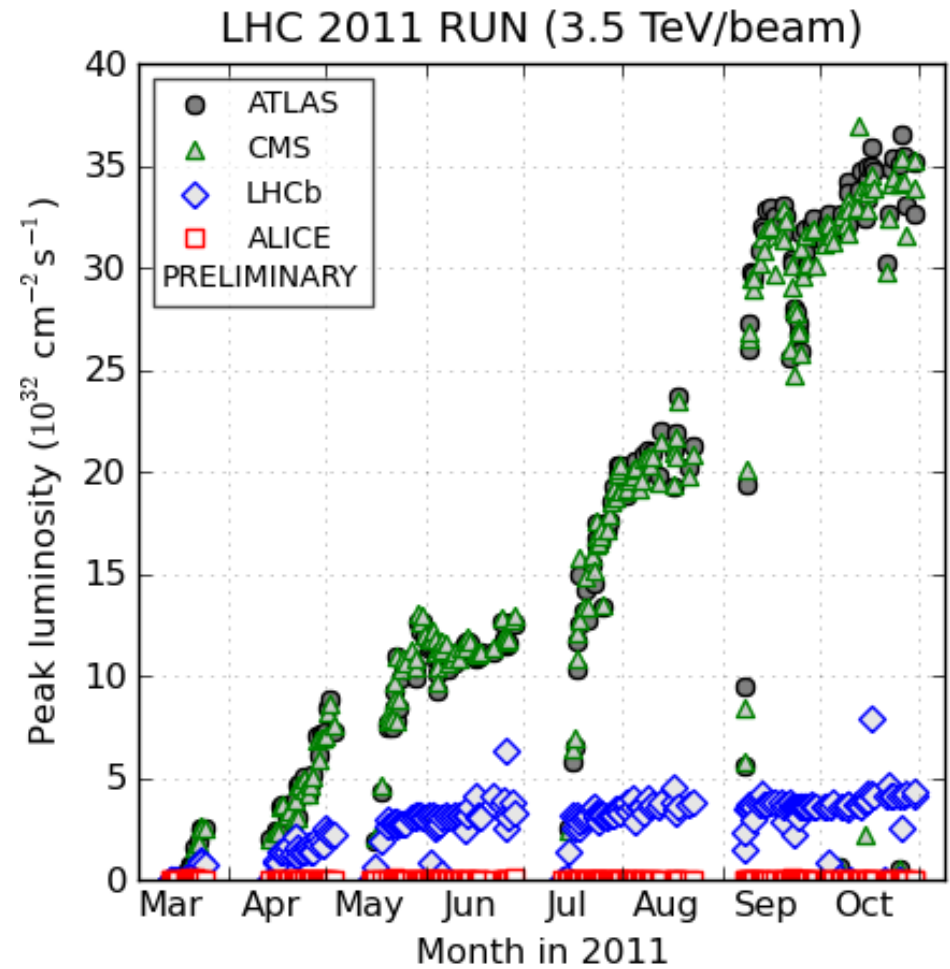

(generated 2011-12-01 19:35 including fill 2267)

# LHC performance 2012

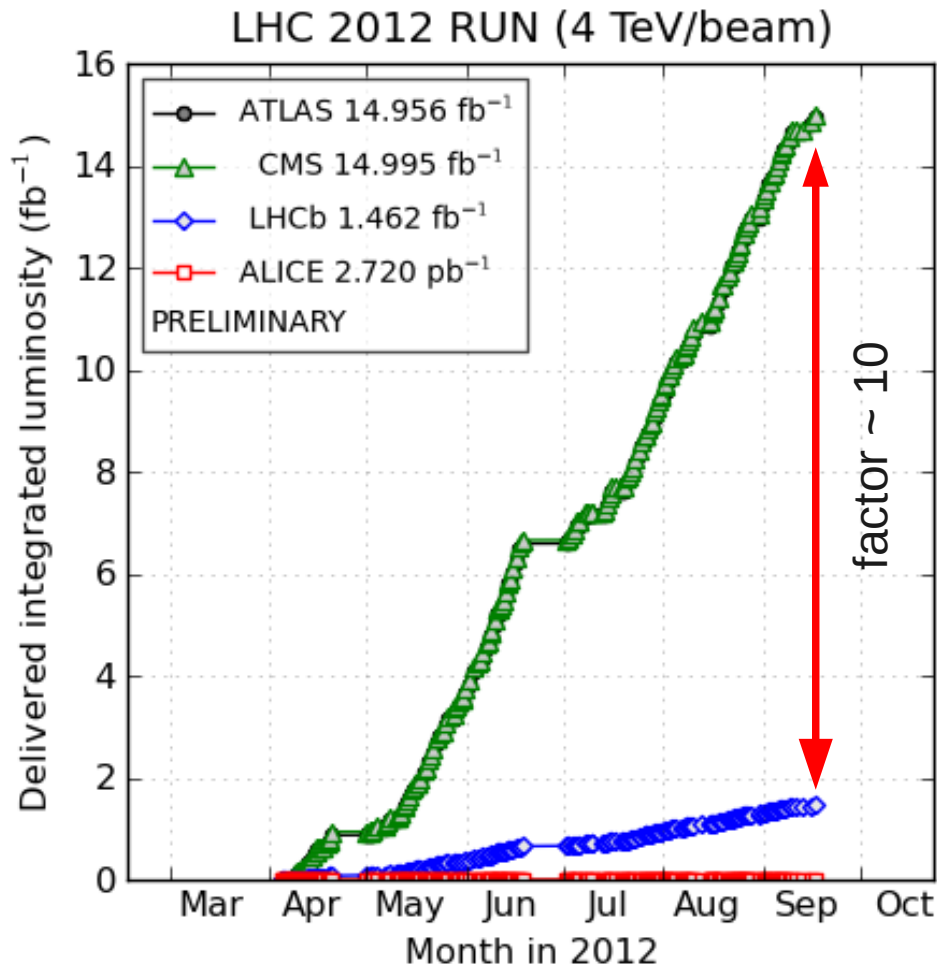

(generated 2012-09-22 18:17 including fill 3071)

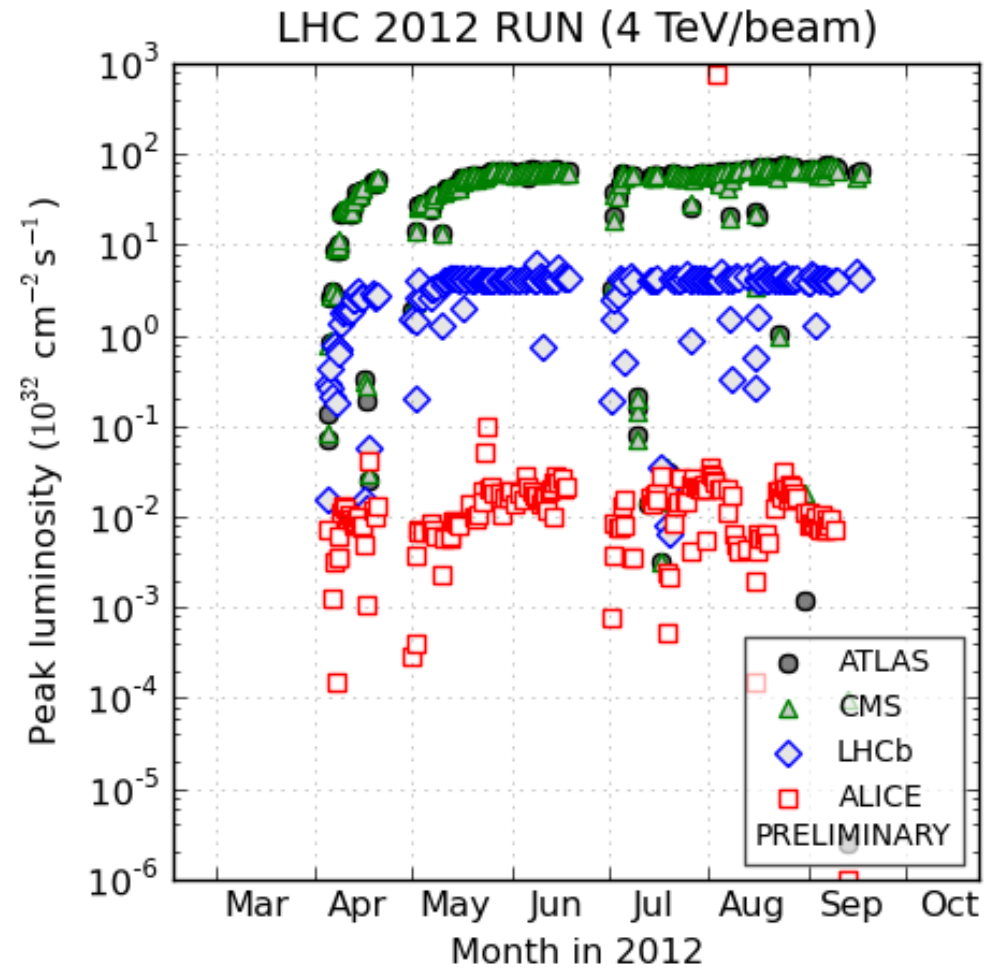

(generated 2012-09-22 18:17 including fill 3071)

# PROTON PHYSICS: STABLE BEAMS

Energy:

3500 GeV

I(B1):

1.63e+14

I(B2):

1.61e+14

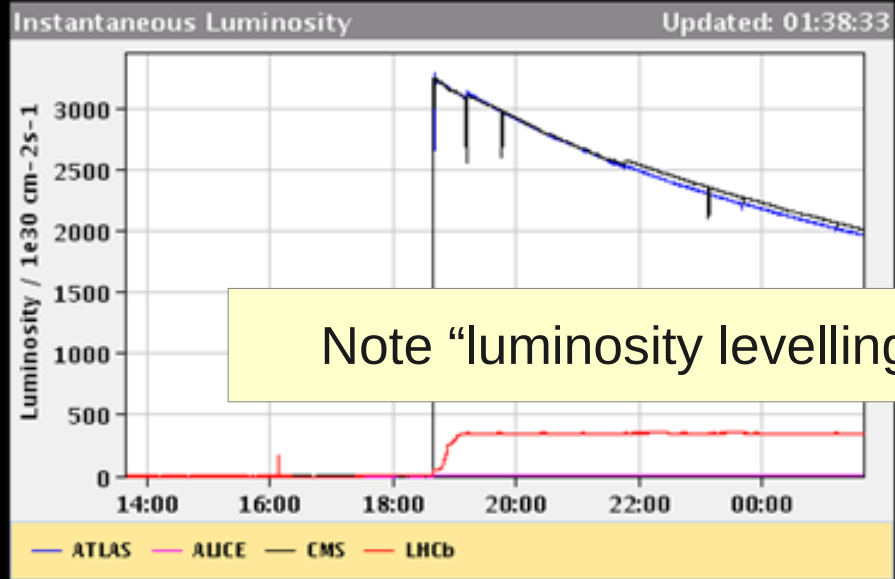
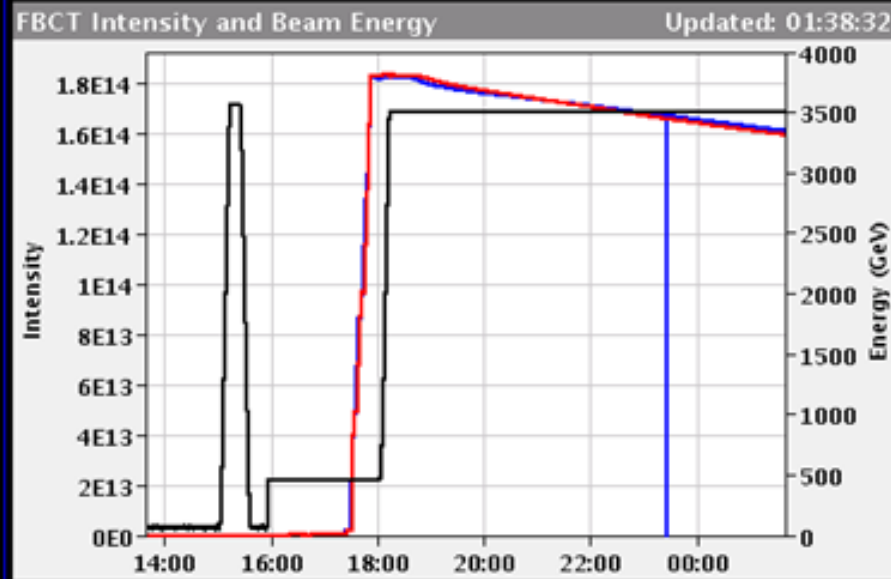

Comments 03-10-2011 01:37:51 :

\*\*\* STABLE BEAMS \*\*\*

!!! CONGRATULATIONS TO LHCb !!!

!!! FOR THEIR 1ST 1.00/fb !!!

BIS status and SMP flags

B1

B2

Link Status of Beam Permits

true true

Global Beam Permit

true true

Setup Beam

false false

Beam Presence

true true

Moveable Devices Allowed In

true true

Stable Beams

true true

PM Status B1

ENABLED

PM Status B2

ENABLED

# Selected highlights of results

## Rare Decays



$$B_s \rightarrow \mu^+ \mu^-$$

## Killer app. for new physics discovery

Very rare in Standard Model due to

- absence of tree-level FCNC
- helicity suppression
- CKM suppression
- ... all features which are not necessarily reproduced in extended models

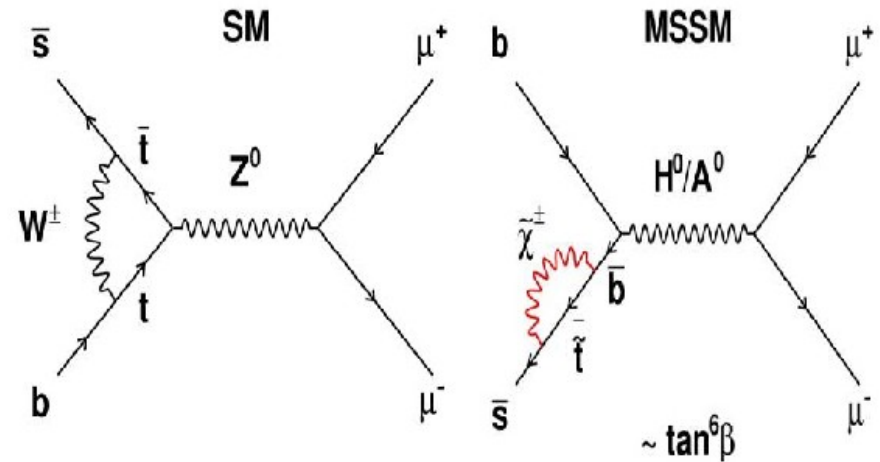

$$B(B_s \rightarrow \mu^+ \mu^-)^{SM} = (3.2 \pm 0.3) \times 10^{-9}$$

$$B(B_s \rightarrow \mu^+ \mu^-)^{MSSM} \sim \tan^6 \beta / M_{A^0}^4$$

# Latest results on $B_s \rightarrow \mu^+ \mu^-$

ATLAS (2.4/fb)  
Phys.Lett. B713 (2012) 387

CMS (5/fb)  
J. High Energy Phys. 04 (2012) 033

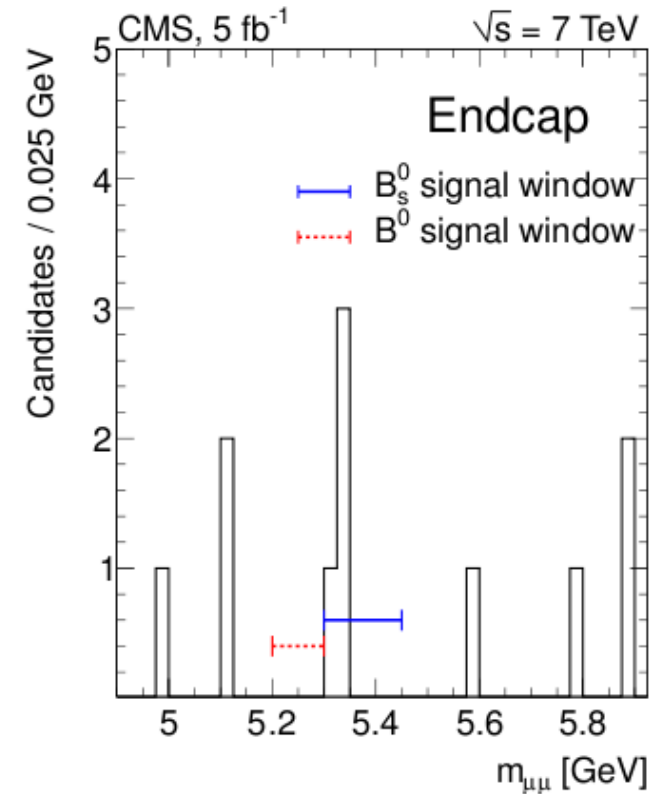
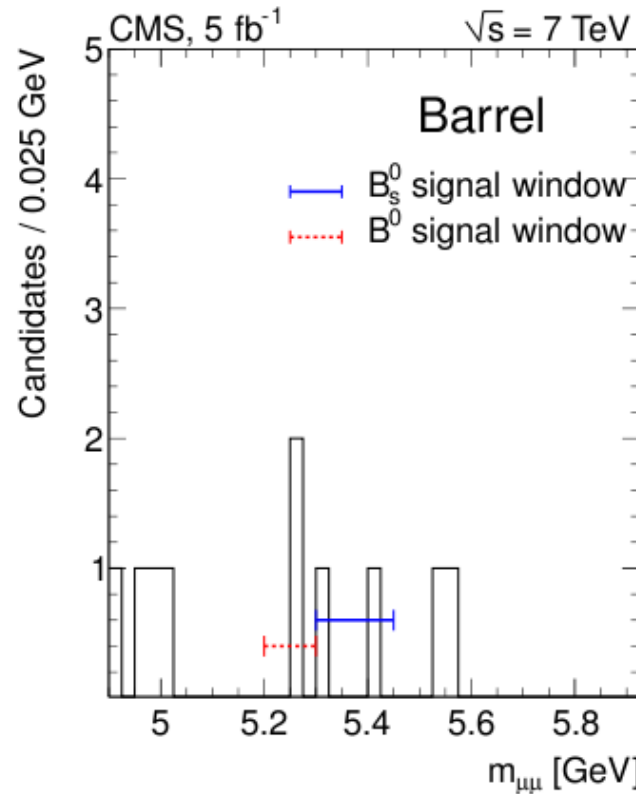
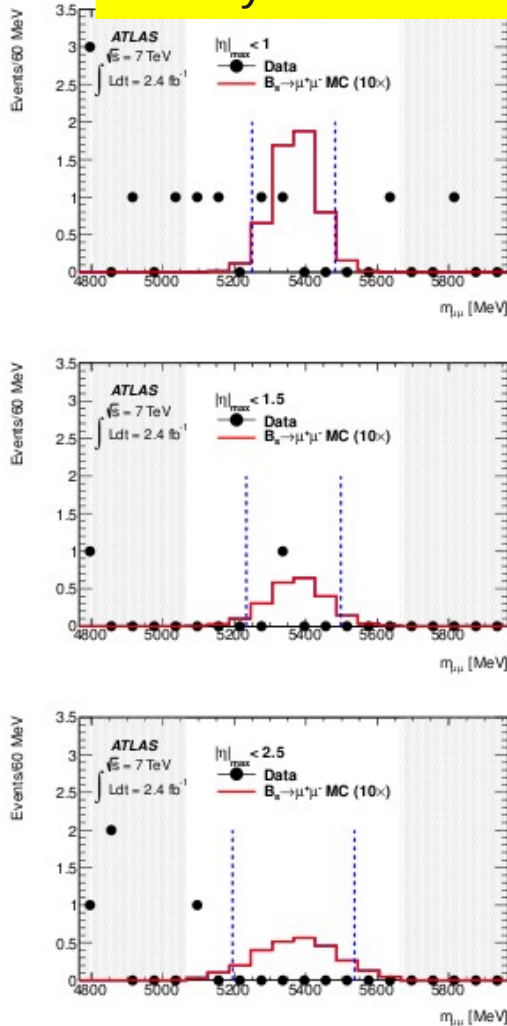

ATLAS  $B(B_s \rightarrow \mu^+ \mu^-) < 2.2 \text{ (1.9)} \times 10^{-8}$  @ 95% (90%) CL  
CMS  $B(B_s \rightarrow \mu^+ \mu^-) < 7.7 \text{ (6.4)} \times 10^{-9}$  @ 95% (90%) CL

# Latest results on $B_s \rightarrow \mu^+ \mu^-$

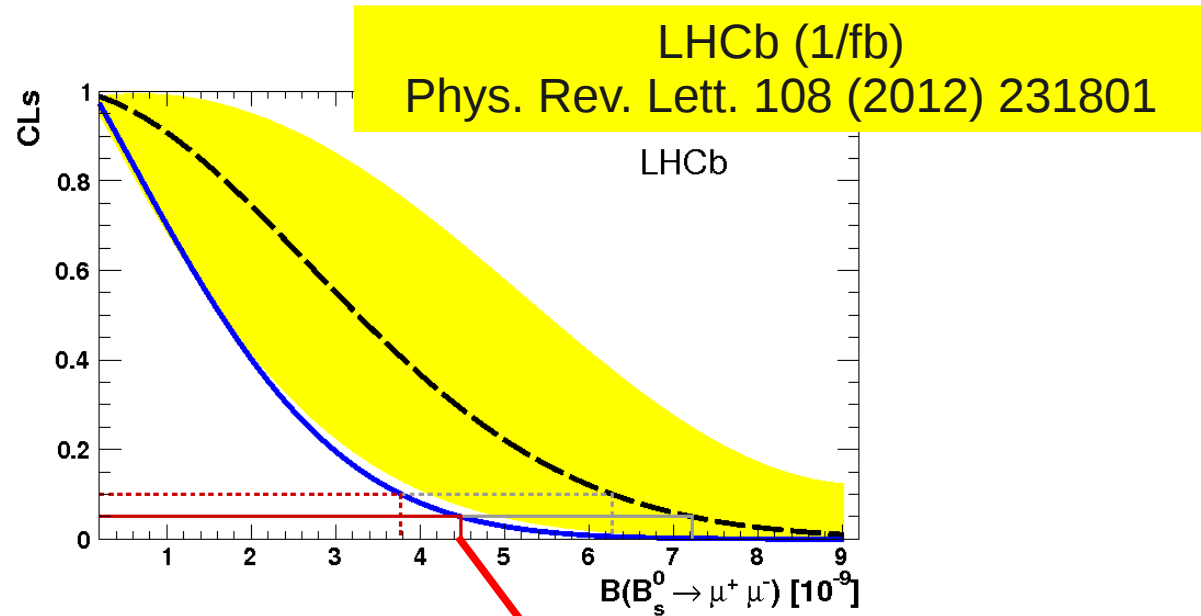
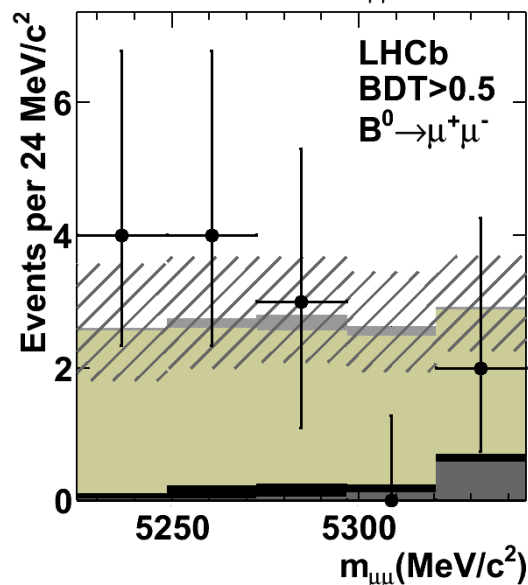
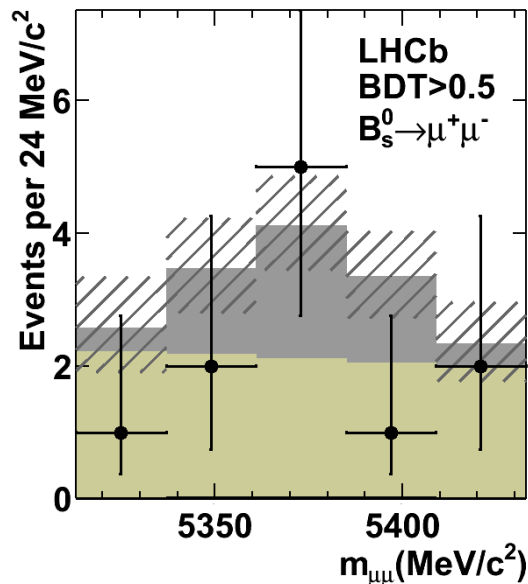

Mode	Limit	at 90% CL	at 95% CL
$B_s^0 \rightarrow \mu^+ \mu^-$	Exp. bkg+SM	$6.3 \times 10^{-9}$	$7.2 \times 10^{-9}$
	Exp. bkg	$2.8 \times 10^{-9}$	$3.4 \times 10^{-9}$
	Observed	$3.8 \times 10^{-9}$	$4.5 \times 10^{-9}$
$B^0 \rightarrow \mu^+ \mu^-$	Exp. bkg	$0.91 \times 10^{-9}$	$1.1 \times 10^{-9}$
	Observed	$0.81 \times 10^{-9}$	$1.0 \times 10^{-9}$

Standard Model expectation, e.g.  $(3.2 \pm 0.3) \times 10^{-9}$   
Buras et al, arXiv:1208.0934

N.B. Should be corrected up by 9% since measurement is of the time-integrated branching fraction (arXiv:1204.1737)

# Implications

G.Dissertori Moriond QCD summary talk:

“Numbers most often mentioned:  $3.2 \times 10^{-9}$  and 125”

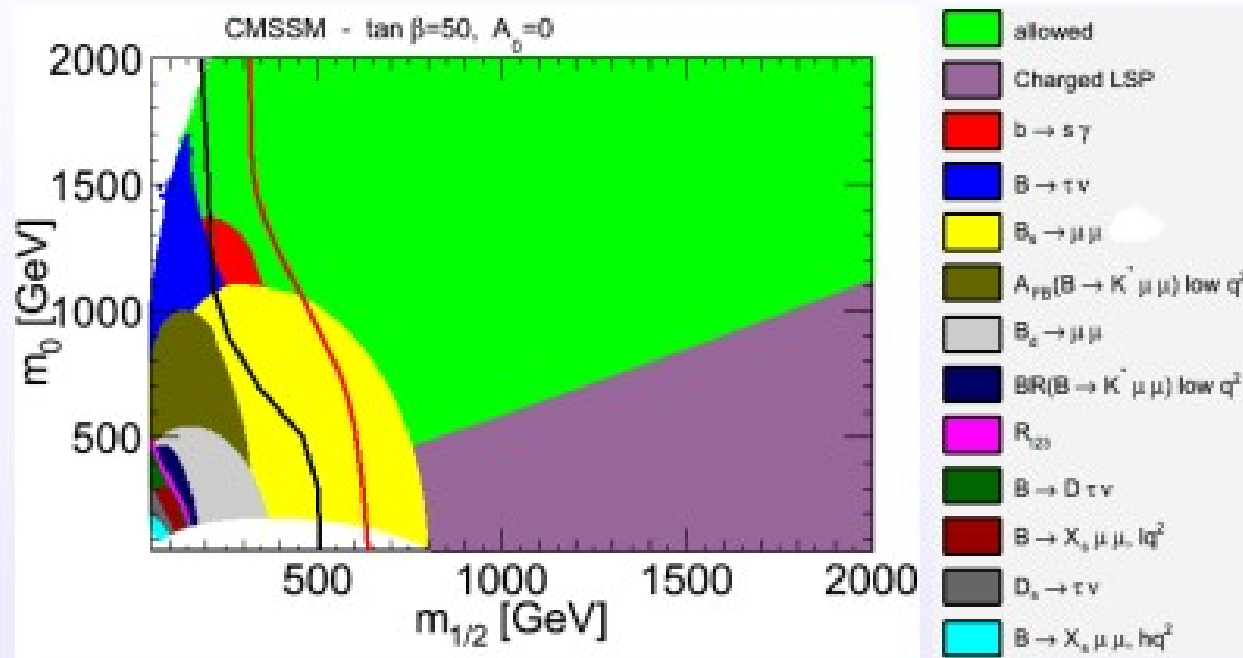

Black line: CMS exclusion limit with  $1.1 \text{ fb}^{-1}$  data

Red line: CMS exclusion limit with  $4.4 \text{ fb}^{-1}$  data

... before ...

SuperIso v3.2+



# Implications

G.Dissertori Moriond QCD summary talk:

“Numbers most often mentioned:  $3.2 \times 10^{-9}$  and 125”

*“the wow plot”*

Simple TeV-scale models with large  $\tan \beta$  ~ ruled out

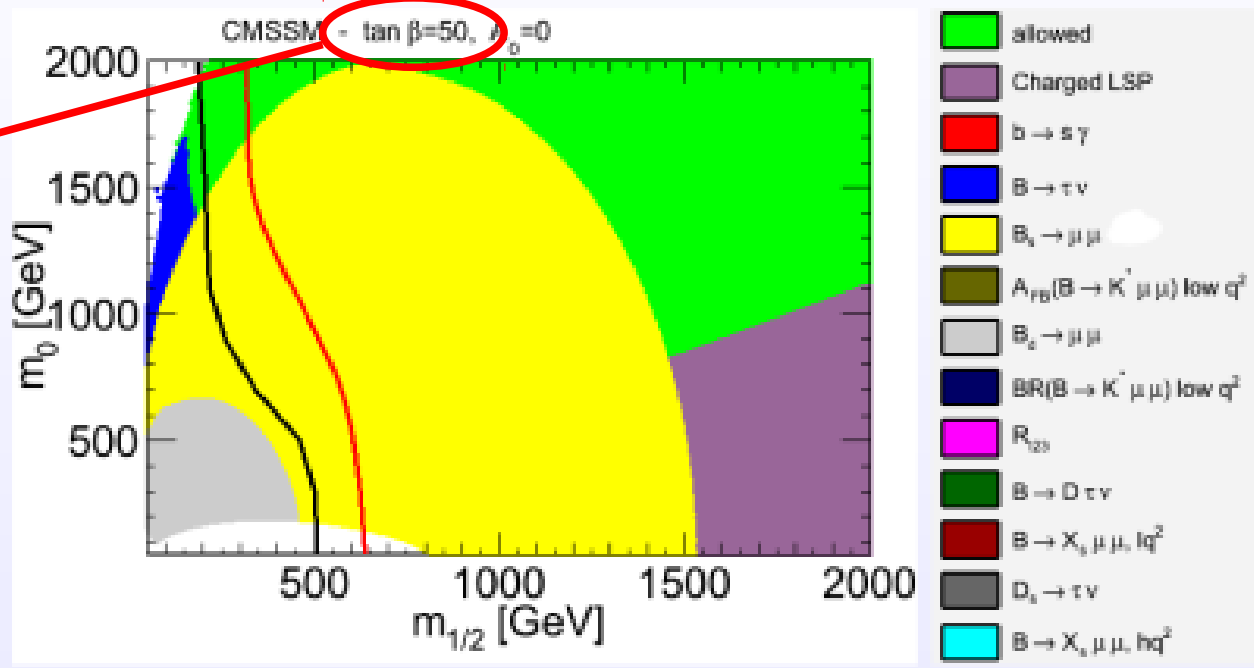

Black line: CMS exclusion limit with  $1.1 \text{ fb}^{-1}$  data  
 Red line: CMS exclusion limit with  $4.4 \text{ fb}^{-1}$  data  
 New LHCb limits for  $\text{BR}(B_s \rightarrow \mu^+ \mu^-)$  and  $\text{BR}(B_d \rightarrow \mu^+ \mu^-)$

... after ...

Superba v3.2+

$$B \rightarrow K^* \mu^+ \mu^-$$

- $B_d \rightarrow K^{*0} \mu^+ \mu^-$  provides complementary approach to search for new physics in  $b \rightarrow s l^+ l^-$  FCNC processes
  - rates, angular distributions and asymmetries sensitive to NP
  - superb laboratory for NP tests
  - **experimentally clean signature**
  - many kinematic variables ...
  - **... with clean theoretical predictions**

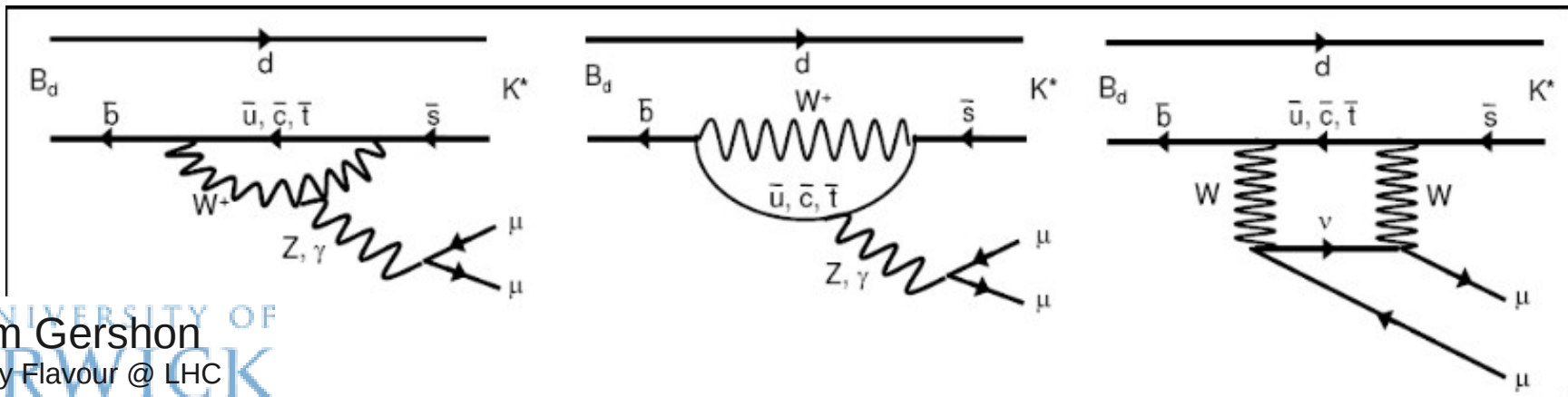

# Differential branching fraction and angular analysis of the $B^0 \rightarrow K^{*0} \mu^+ \mu^-$ decay

LHCb-CONF-2012-008

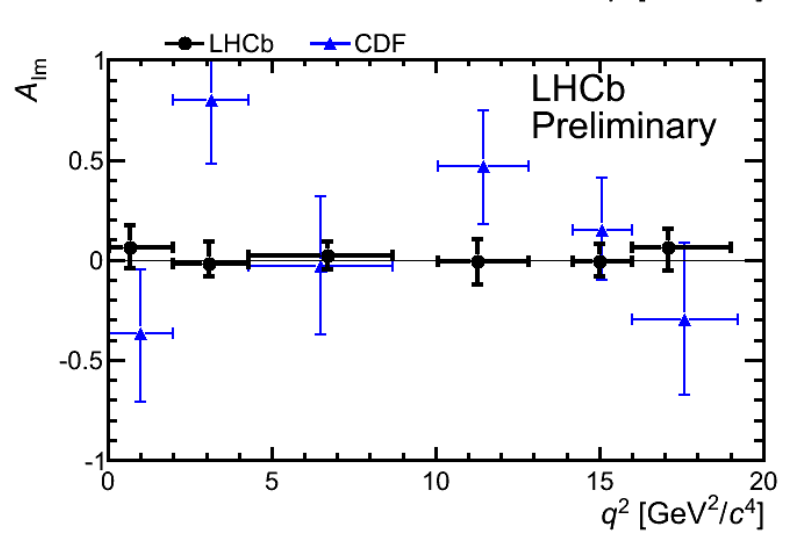
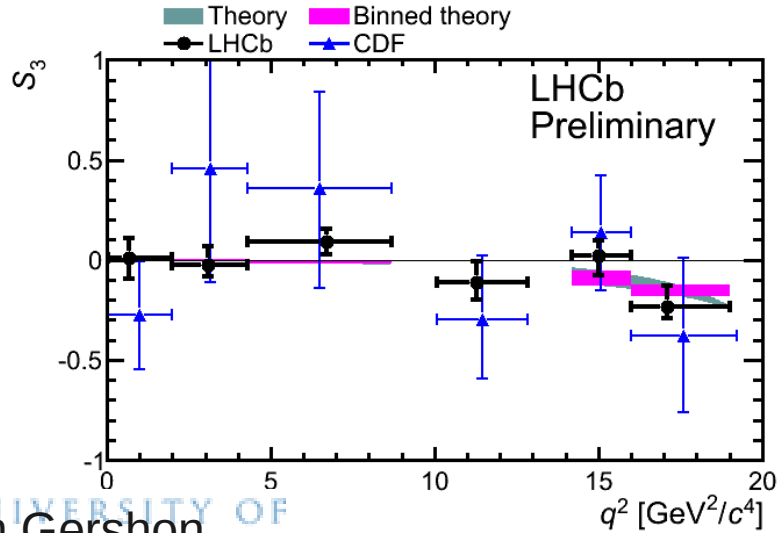
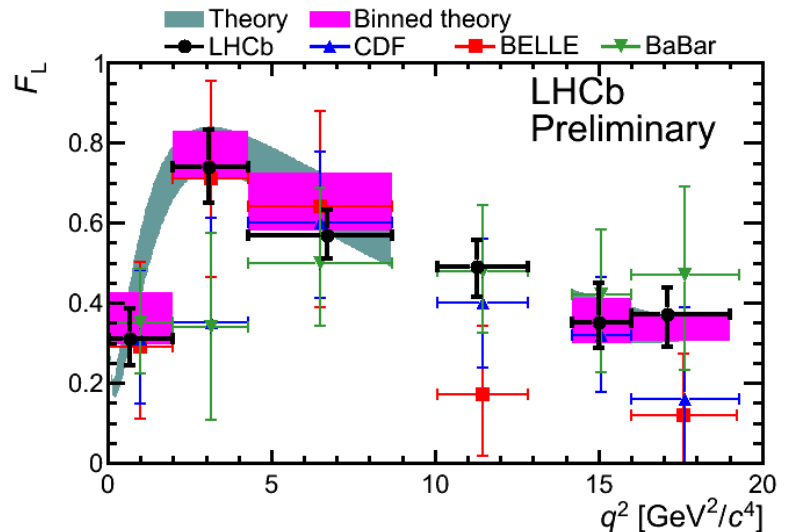
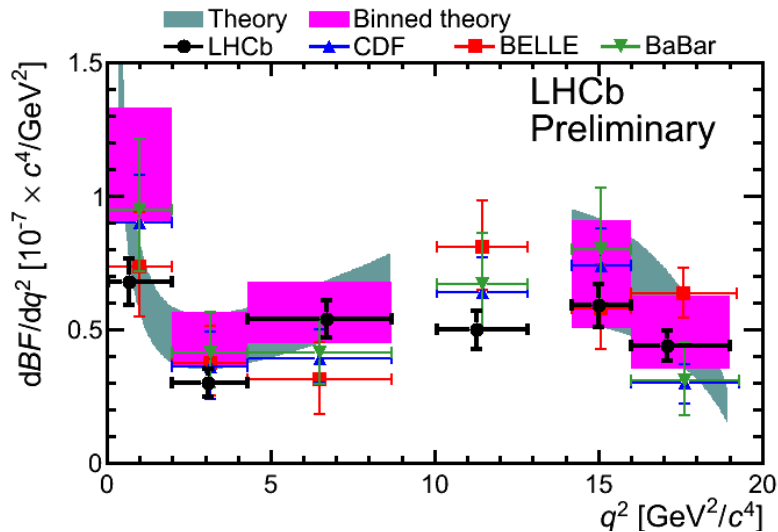

# Differential branching fraction and angular analysis of the $B^0 \rightarrow K^{*0} \mu^+ \mu^-$ decay

LHCb-CONF-2012-008

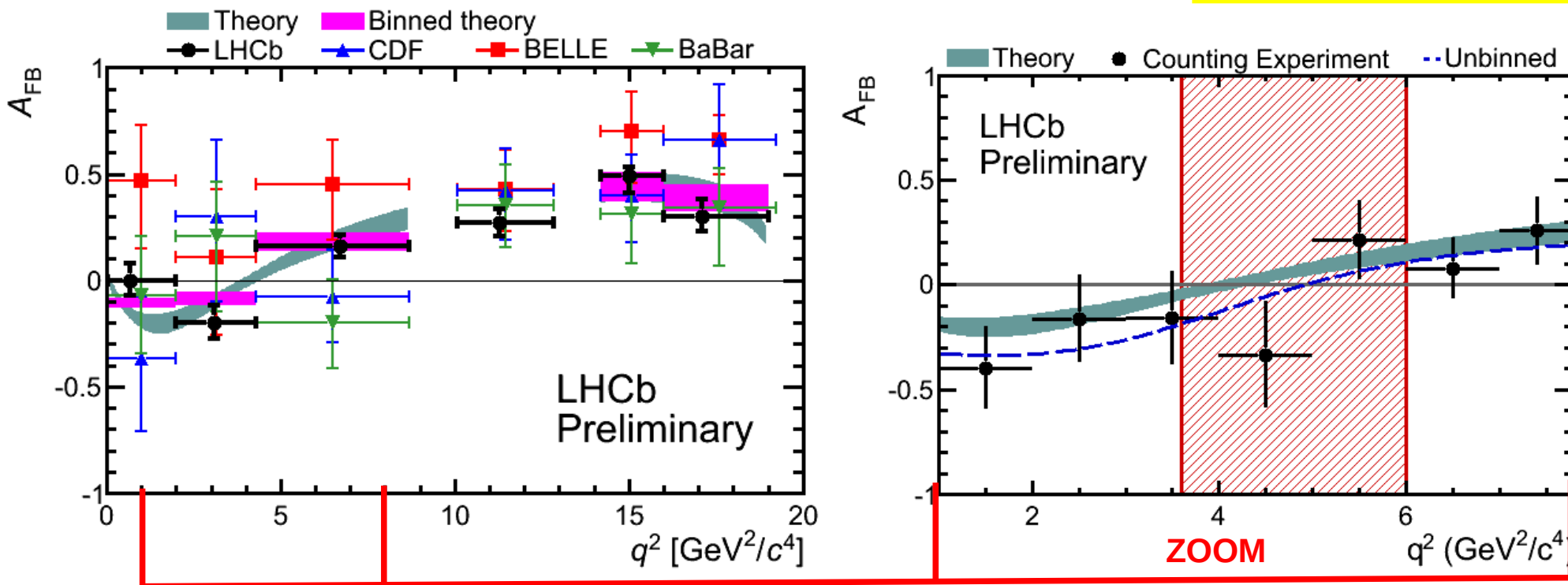

First measurement of the zero-crossing point of the forward-backward asymmetry

$$q_0^2 = (4.9^{+1.1}_{-1.3}) \text{ GeV}^2$$

(SM predictions in the range 4.0 – 4.3 GeV<sup>2</sup>)

# Isospin asymmetry in $B \rightarrow K^{(*)} \mu \mu$

LHCb  
 J. High Energy Phys. 07 (2012) 133

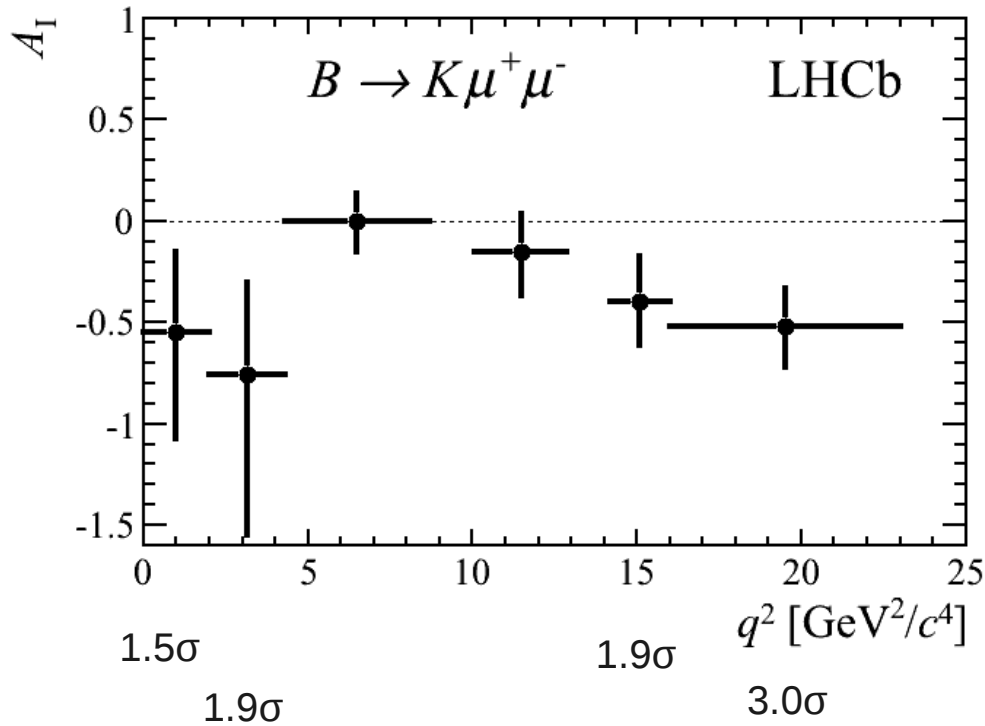

Deviation from zero integrated over  $q^2 \sim 4.4\sigma$   
 Consistent with previous measurements  
 (BaBar, Belle, CDF)

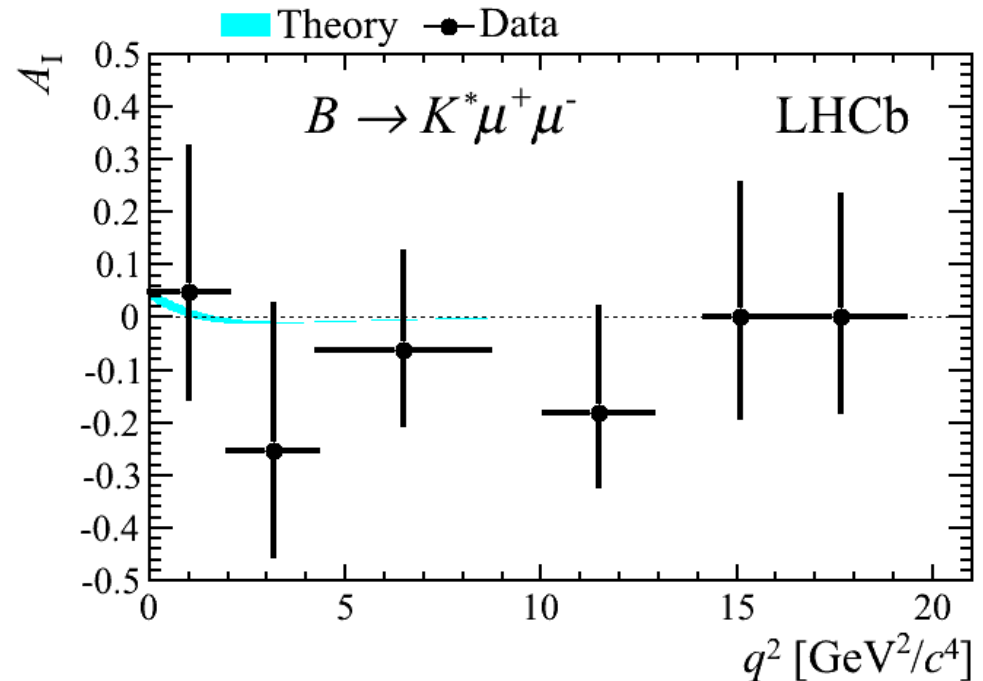

Consistent with zero & with SM prediction  
 Consistent with previous measurements  
 (BaBar, Belle, CDF)



# Selected highlights of results CP violation

# Evidence for CP violation in $D \rightarrow h^+h^-$ decays

LHCb PRL 108 (2012) 111602

Measurement of CP asymmetry at pp collider requires knowledge of production and detection asymmetries; e.g. for  $D^0 \rightarrow f$ , where D meson flavour is tagged by  $D^{*+} \rightarrow D^0\pi^+$  decay

$$A_{\text{raw}}(f) = A_{CP}(f) + A_D(f) + A_D(\pi_s^+) + A_P(D^{*+}).$$

final state detection asymmetry vanishes for CP eigenstate

Cancel asymmetries by taking difference of raw asymmetries in two different final states (Since  $A_D$  and  $A_P$  depend on kinematics, must bin or reweight to ensure cancellation)

$$\Delta A_{CP} = A_{\text{raw}}(K^-K^+) - A_{\text{raw}}(\pi^-\pi^+).$$

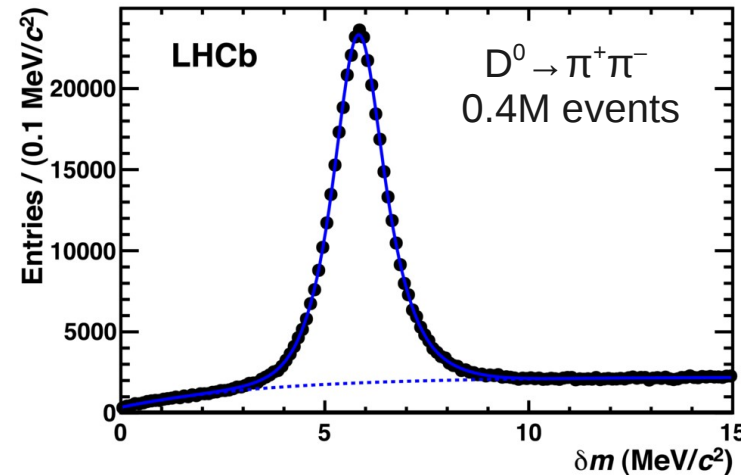
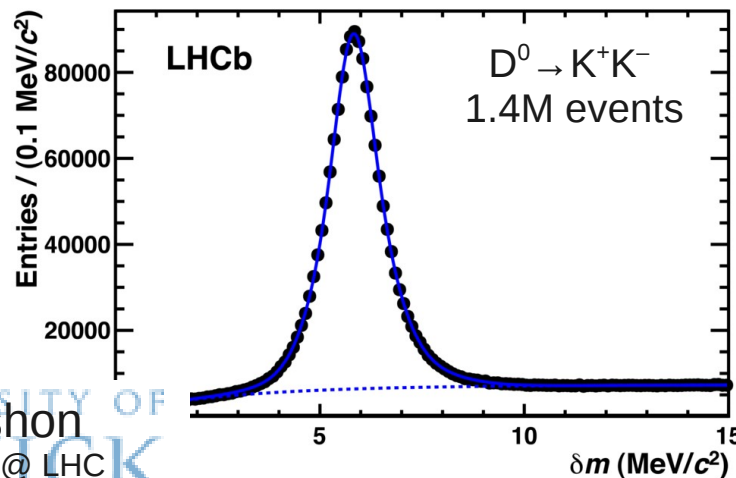

# Evidence for CP violation in $D \rightarrow h^+h^-$ decays

LHCb PRL 108 (2012) 111602

Result, based on 0.62/fb of 2011 data  
 $\Delta A_{CP} = [-0.82 \pm 0.21(\text{stat.}) \pm 0.11(\text{syst.})]\%$

Naively expected to be much smaller  
 in the Standard Model

$\Delta A_{CP}$  related mainly to direct CP violation  
 (contribution from indirect CPV suppressed by  
 difference in mean decay time)

$$\begin{aligned} \Delta A_{CP} &\equiv A_{CP}(K^-K^+) - A_{CP}(\pi^-\pi^+) \\ &= [a_{CP}^{\text{dir}}(K^-K^+) - a_{CP}^{\text{dir}}(\pi^-\pi^+)] + \frac{\Delta\langle t \rangle}{\tau} a_{CP}^{\text{ind}} \end{aligned}$$

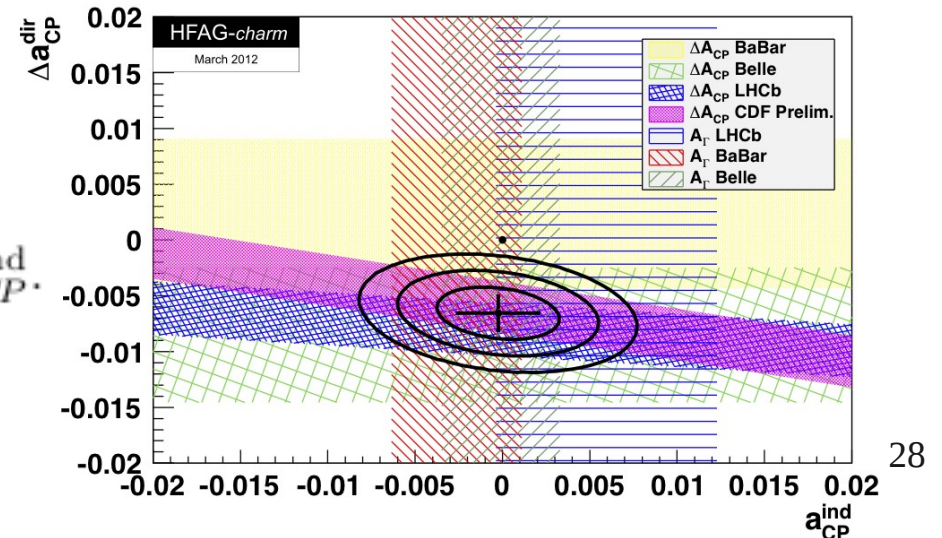
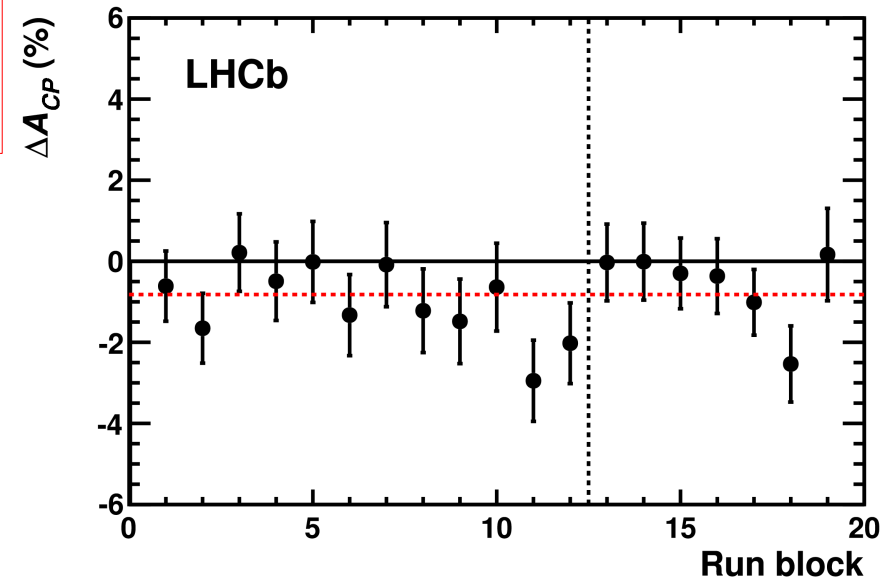

B → DK decays  
give theoretically clean  
way to measure  
CKM phase  $\gamma$

# B → DK decays

## “GLW” and “ADS” methods

LHCb  
Phys. Lett. B 712 (2012) 203

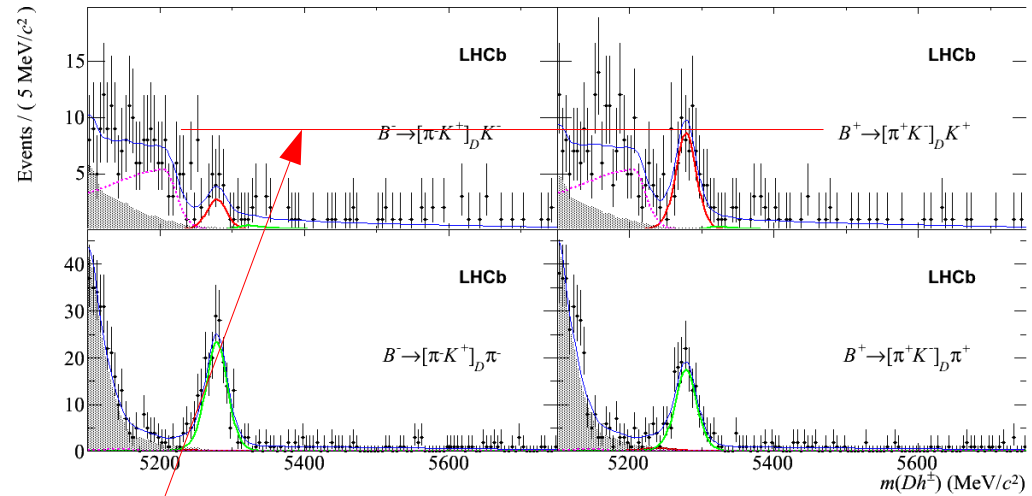
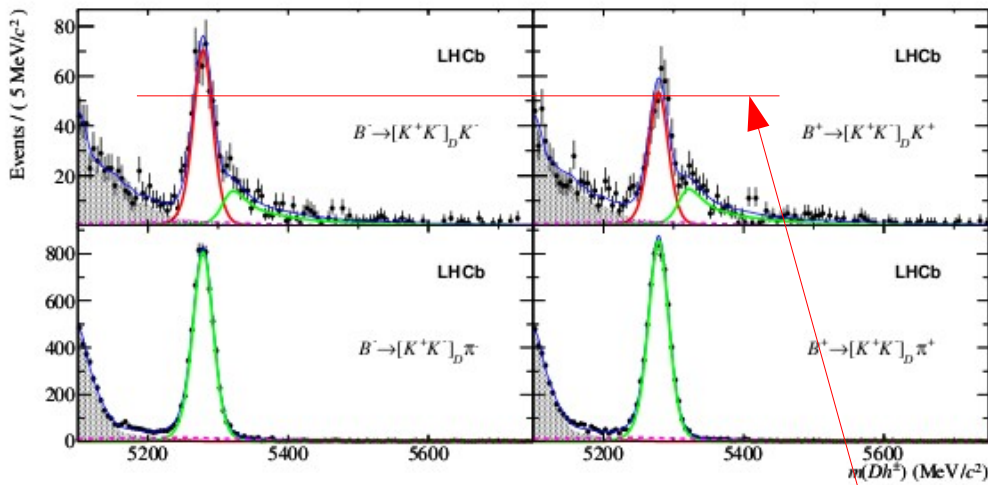

$D_{CP} K A_{CP+}$  **HFAG**  
Moriond 2012  
PRELIMINARY

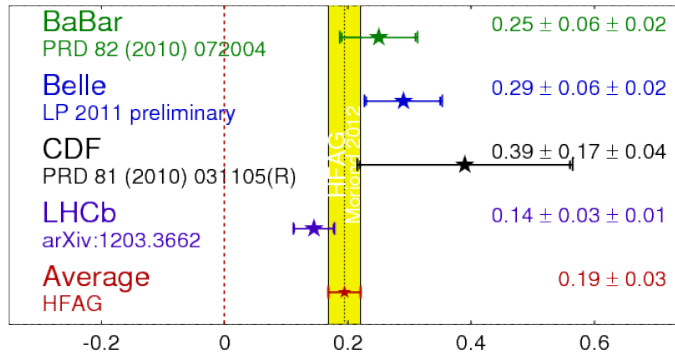

$D_K \pi K R_{ADS}$  **HFAG**  
Moriond 2012  
PRELIMINARY

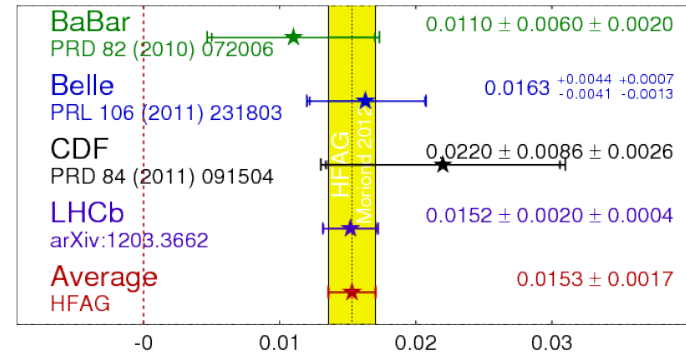

Observation of CP violation in B → DK decays

$$\Phi_s = -2\beta_s (B_s \rightarrow J/\psi\phi)$$

- VV final state

three helicity amplitudes

→ mixture of CP-even and CP-odd

disentangled using angular & time-dependent distributions

→ additional sensitivity

many correlated variables

→ complicated analysis

- LHCb also uses  $B_s \rightarrow J/\psi f_0$  ( $f_0 \rightarrow \pi^+\pi^-$ )

- CP eigenstate; simpler analysis

- fewer events; requires input from  $J/\psi\phi$  analysis ( $\Gamma_s, \Delta\Gamma_s$ )

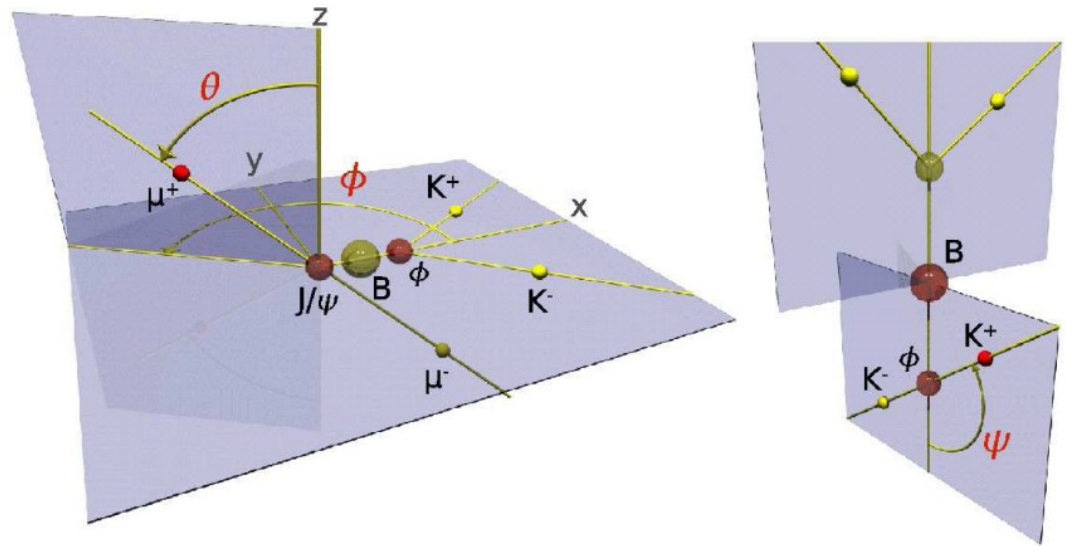



# CP violation in $B_s \rightarrow J/\psi\phi$ & $J/\psi\pi\pi$

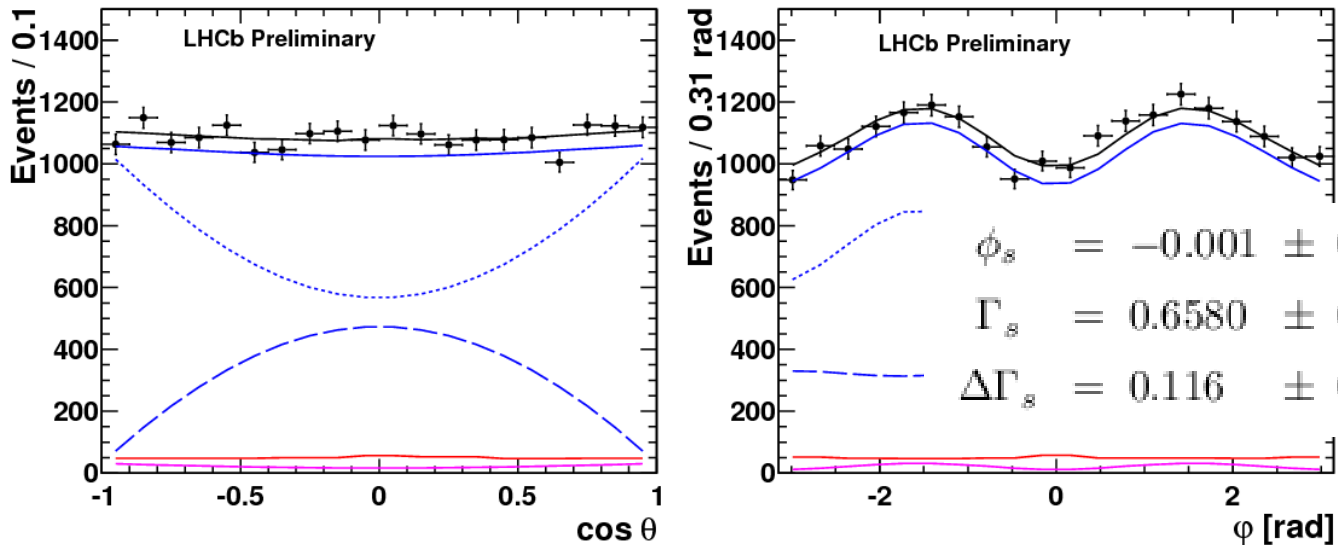
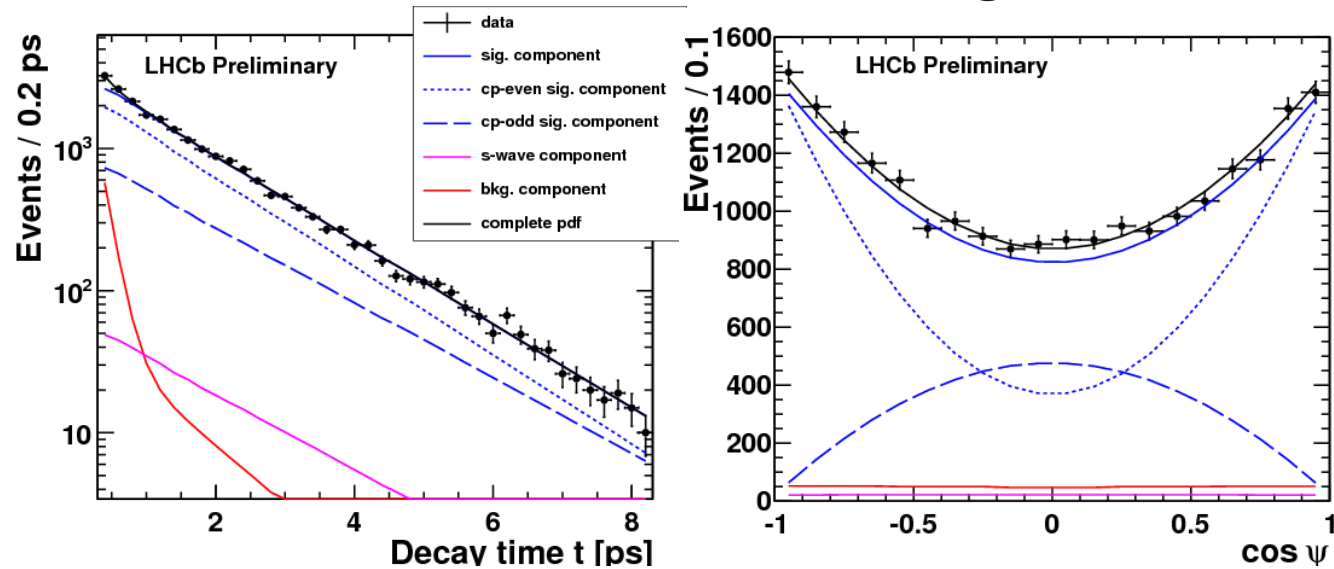

LHCb-CONF-2012-002

$$\begin{aligned} \phi_s &= -0.001 \pm 0.101 \text{ (stat)} \pm 0.027 \text{ (syst)} \text{ rad,} \\ \Gamma_s &= 0.6580 \pm 0.0054 \text{ (stat)} \pm 0.0066 \text{ (syst)} \text{ ps}^{-1}, \\ \Delta\Gamma_s &= 0.116 \pm 0.018 \text{ (stat)} \pm 0.006 \text{ (syst)} \text{ ps}^{-1}. \end{aligned}$$

# CP violation in $B_s \rightarrow J/\psi\phi$ & $J/\psi\pi\pi$

- Ambiguity resolution
- Tagged time-dependent angular analysis of  $J/\psi\phi$  with  $1/\text{fb}$
- Amplitude analysis to determine CP content of  $J/\psi\pi\pi$
- Tagged time-dependent analysis of  $J/\psi\pi\pi$

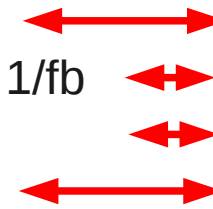

PRL 108 (2012) 241801  
 LHCb-CONF-2012-002  
 PRD 86 (2012) 052006  
 PLB 713 (2012) 378

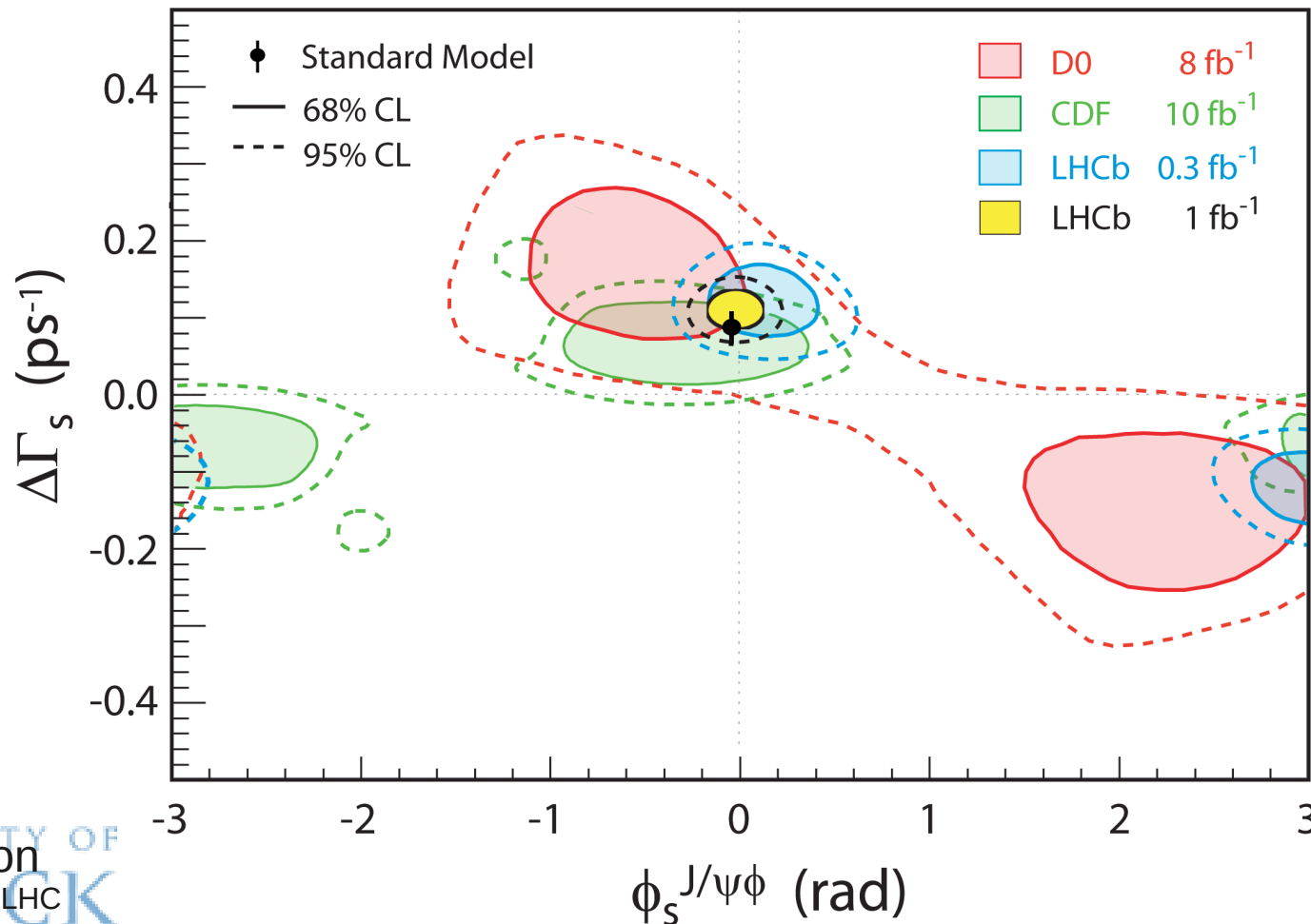

# ATLAS results on $B_s \rightarrow J/\psi\phi$

arXiv:1208.0572

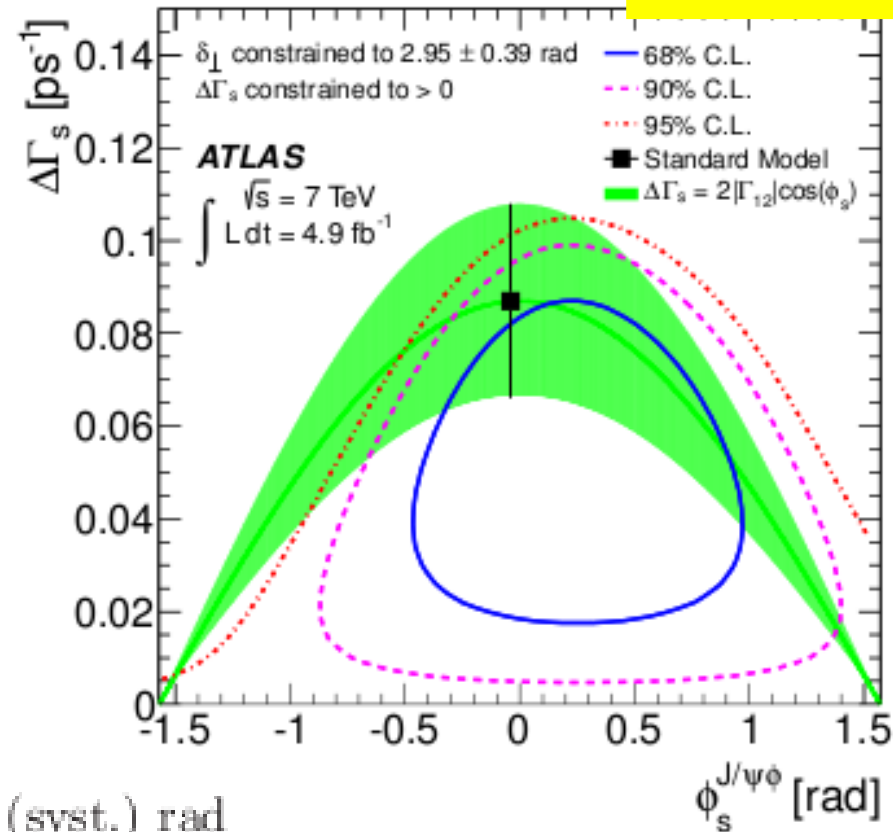

$$\phi_s = 0.22 \pm 0.41 \text{ (stat.)} \pm 0.10 \text{ (syst.) rad}$$

$$\Delta\Gamma_s = 0.053 \pm 0.021 \text{ (stat.)} \pm 0.008 \text{ (syst.) ps}^{-1}$$

$$\Gamma_s = 0.677 \pm 0.007 \text{ (stat.)} \pm 0.004 \text{ (syst.) ps}^{-1}$$

untagged, hence reduced sensitivity

high statistics measurements with 4.9/fb

# Semileptonic asymmetries

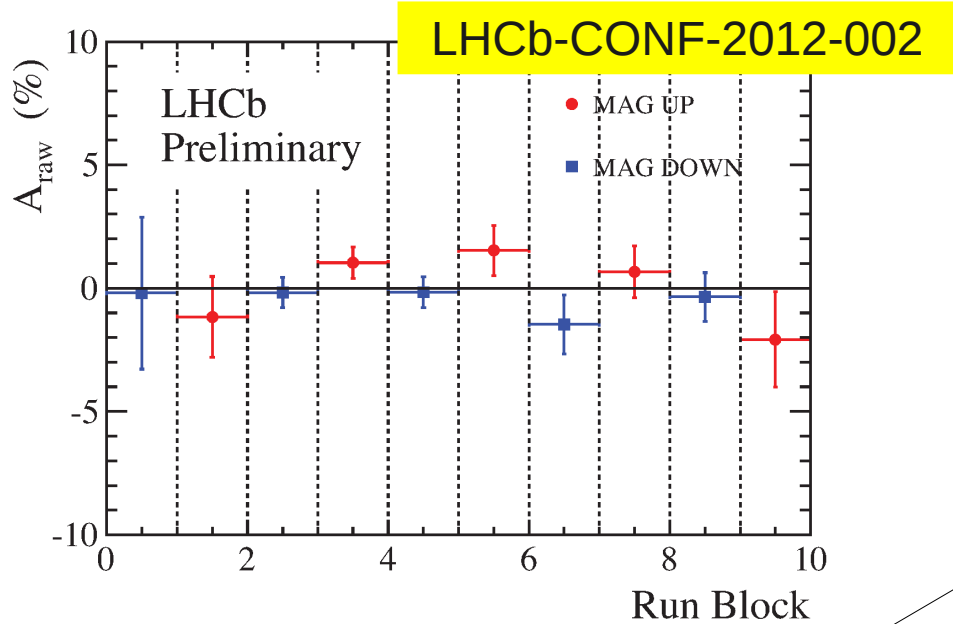

$$a_{\text{sl}}^s = (-0.24 \pm 0.54 \pm 0.33)\%$$

Based on  $B_s \rightarrow D_s \mu \nu X$  with  $D_s \rightarrow \phi \pi$

D0 inclusive dimuon result  $3.9\sigma$  from SM  
PRD 84 (2011) 052007

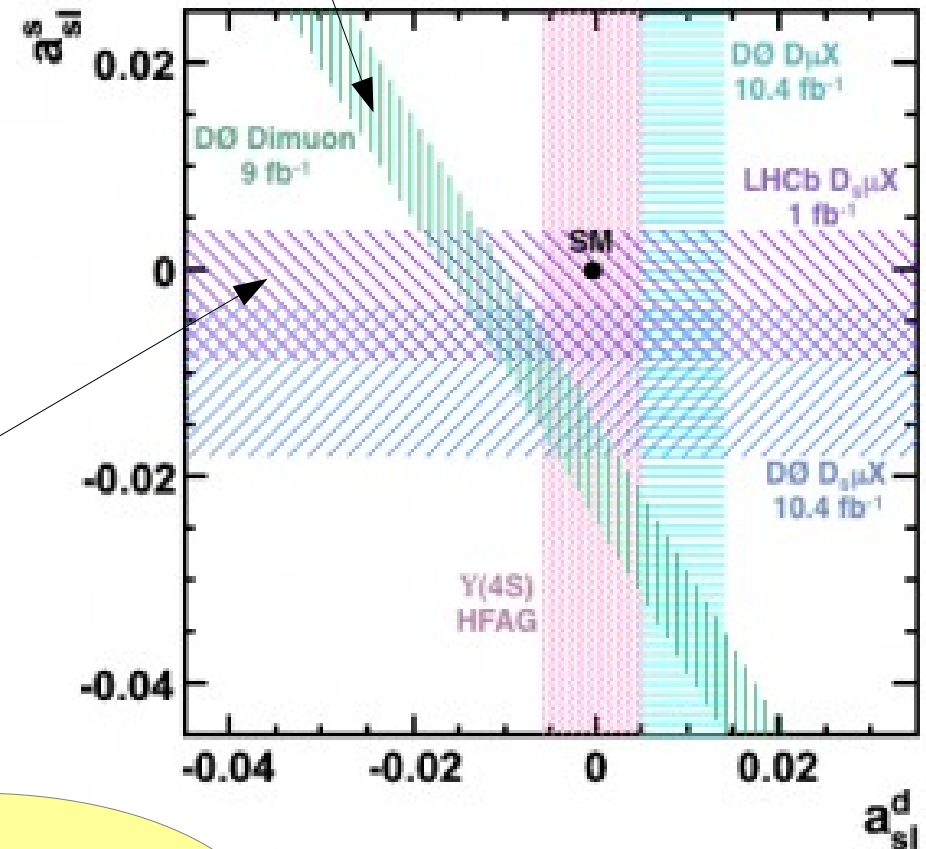

Situation unclear –  
improved measurements  
needed

# The LHCb upgrade



# LHCb upgrade

- To fully exploit LHC potential for heavy flavour physics will require an upgrade to LHCb
  - full readout & trigger at 40 MHz to enable high L running
  - “high L” =  $10^{33}/\text{cm}^2/\text{s}$  (so independent of machine upgrade)
  - planned for 2018 shutdown
- With full software trigger, LHCb upgrade will be a general purpose detector in the forward region
  - physics case extends far beyond flavour physics
  - (e.g. search for long-lived exotic particles)

# The all important trigger

## Challenge is

- to efficiently select most interesting B decays
- while maintaining manageable data rates

## Main backgrounds

- “minimum bias” inelastic pp scattering
- other charm and beauty decays

## Handles

- high  $p_T$  signals (muons)
- displaced vertices

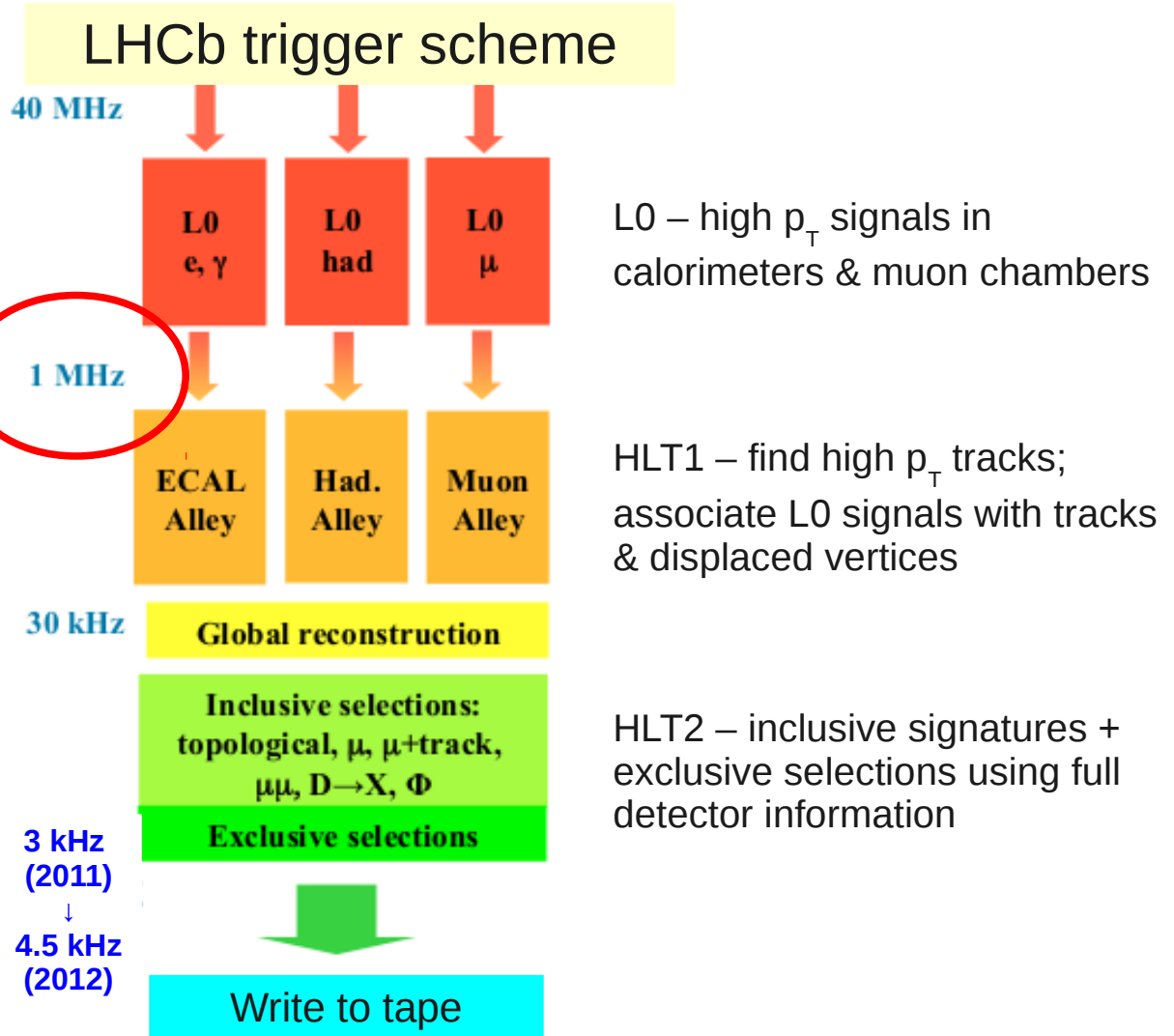

Limitation is at 1 MHz L0 o/p

# LHCb detector upgrade

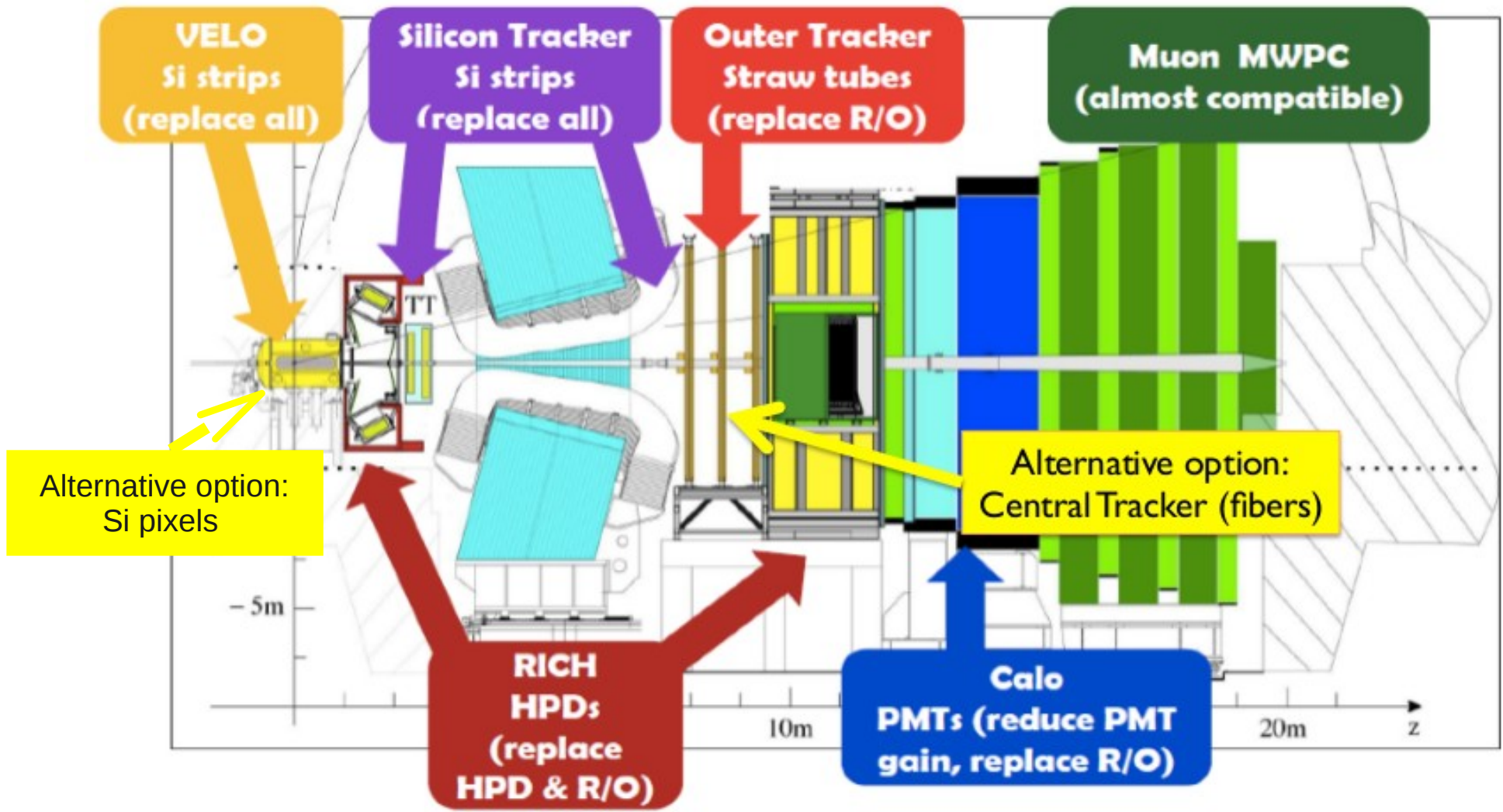

# Upgrade – expected sensitivities

Type	Observable	Current precision	LHCb 2018	Upgrade (50 fb <sup>-1</sup> )	Theory uncertainty
$B_s^0$ mixing	$2\beta_s (B_s^0 \rightarrow J/\psi \phi)$	0.10 [9]	0.025	0.008	$\sim 0.003$
	$2\beta_s (B_s^0 \rightarrow J/\psi f_0(980))$	0.17 [10]	0.045	0.014	$\sim 0.01$
	$A_{\text{fs}}(B_s^0)$	$6.4 \times 10^{-3}$ [18]	$0.6 \times 10^{-3}$	$0.2 \times 10^{-3}$	$0.03 \times 10^{-3}$
Gluonic penguin	$2\beta_s^{\text{eff}}(B_s^0 \rightarrow \phi\phi)$	–	0.17	0.03	0.02
	$2\beta_s^{\text{eff}}(B_s^0 \rightarrow K^{*0}\bar{K}^{*0})$	–	0.13	0.02	$< 0.02$
	$2\beta_s^{\text{eff}}(B^0 \rightarrow \phi K_S^0)$	0.17 [18]	0.30	0.05	0.02
Right-handed currents	$2\beta_s^{\text{eff}}(B_s^0 \rightarrow \phi\gamma)$	–	0.09	0.02	$< 0.01$
	$\tau^{\text{eff}}(B_s^0 \rightarrow \phi\gamma)/\tau_{B_s^0}$	–	5 %	1 %	0.2 %
Electroweak penguin	$S_3(B^0 \rightarrow K^{*0}\mu^+\mu^-; 1 < q^2 < 6 \text{ GeV}^2/c^4)$	0.08 [14]	0.025	0.008	0.02
	$s_0 A_{\text{FB}}(B^0 \rightarrow K^{*0}\mu^+\mu^-)$	25 % [14]	6 %	2 %	7 %
	$A_1(K\mu^+\mu^-; 1 < q^2 < 6 \text{ GeV}^2/c^4)$	0.25 [15]	0.08	0.025	$\sim 0.02$
	$\mathcal{B}(B^+ \rightarrow \pi^+\mu^+\mu^-)/\mathcal{B}(B^+ \rightarrow K^+\mu^+\mu^-)$	25 % [16]	8 %	2.5 %	$\sim 10\%$
Higgs penguin	$\mathcal{B}(B_s^0 \rightarrow \mu^+\mu^-)$	$1.5 \times 10^{-9}$ [2]	$0.5 \times 10^{-9}$	$0.15 \times 10^{-9}$	$0.3 \times 10^{-9}$
	$\mathcal{B}(B^0 \rightarrow \mu^+\mu^-)/\mathcal{B}(B_s^0 \rightarrow \mu^+\mu^-)$	–	$\sim 100\%$	$\sim 35\%$	$\sim 5\%$
Unitarity triangle angles	$\gamma (B \rightarrow D^{(*)}K^{(*)})$	$\sim 10\text{--}12^\circ$ [19, 20]	$4^\circ$	$0.9^\circ$	negligible
	$\gamma (B_s^0 \rightarrow D_s K)$	–	$11^\circ$	$2.0^\circ$	negligible
	$\beta (B^0 \rightarrow J/\psi K_S^0)$	$0.8^\circ$ [18]	$0.6^\circ$	$0.2^\circ$	negligible
Charm	$A_\Gamma$	$2.3 \times 10^{-3}$ [18]	$0.40 \times 10^{-3}$	$0.07 \times 10^{-3}$	–
CP violation	$\Delta A_{CP}$	$2.1 \times 10^{-3}$ [5]	$0.65 \times 10^{-3}$	$0.12 \times 10^{-3}$	–

Table 1: Statistical sensitivities of the LHCb upgrade to key observables. For each observable the current sensitivity is compared to that which will be achieved by LHCb before the upgrade, and that which will be achieved with 50 fb<sup>-1</sup> by the upgraded experiment. Systematic uncertainties are expected to be non-negligible for the most precisely measured quantities.

- sample sizes in most exclusive B and D final states far larger than those collected elsewhere
- no serious competition in study of  $B_s$  decays and CP violation

# The need for more precision

- “Imagine if Fitch and Cronin had stopped at the 1% level, how much physics would have been missed”

– A.Soni

- “A special search at Dubna was carried out by Okonov and his group. They did not find a single  $K_L^0 \rightarrow \pi^+\pi^-$  event among **600 decays** into charged particles (Anikira et al., JETP 1962). At that stage the search was terminated by the administration of the lab. **The group was unlucky.**”

– L.Okun

(remember:  $B(K_L^0 \rightarrow \pi^+\pi^-) \sim 2 \cdot 10^{-3}$ )



# Summary

- Concept of LHCb definitively proved
  - Dedicated experiment for heavy flavour physics (forward spectrometer) at a hadron collider
- Many world leading results already with 2011 data ... and many more to come
  - Several new results to be presented at CKM2012 next week
  - Significant increase in available samples with 2012 data
- Standard Model still survives
  - Not a cause for depression! Now probing regions where “realistic” new physics effects might appear
- LHCb upgrade to be installed in 2018
  - Essential next step forward for flavour physics
  - A core component of LHC exploitation