

# Heavy Flavour Physics

## Lecture 1 of 3

Tim Gershon  
University of Warwick

HCPSS 2015  
1 July 2015



# Contents

- **Part 1**
  - Why is flavour physics interesting?
- **Part 2**
  - What do we know from the previous generation of experiments?
- **Part 3**
  - What do we hope to learn from current and future heavy flavour experiments?

Today hope to cover Part 1 & start Part 2

# What is flavour physics?

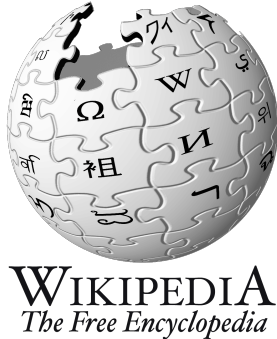

## Flavour (particle physics)

From Wikipedia, the free encyclopedia

In [particle physics](#), **flavour** or **flavor** is a [quantum number](#) of [elementary particles](#). In [quantum chromodynamics](#), flavour is a global symmetry. In the [electroweak theory](#), on the other hand, this symmetry is broken, and flavour-changing processes exist, such as quark decay or [neutrino oscillations](#).

“The term flavor was first used in particle physics in the context of the quark model of hadrons. It was coined in 1971 by Murray Gell-Mann and his student at the time, Harald Fritzsch, at a Baskin-Robbins ice-cream store in Pasadena. Just as ice cream has both color and flavor so do quarks.”

RMP 81 (2009) 1887

### Flavour in [particle physics](#)

#### Flavour [quantum numbers](#):

- Baryon number:  $B$
- Lepton number:  $L$
- Strangeness:  $S$
- Charm:  $C$
- Bottomness:  $B'$
- Topness:  $T$
- Isospin:  $I$  or  $I_3$
- Weak isospin:  $T$  or  $T_3$
- Electric charge:  $Q$
- X-charge:  $X$

#### Combinations:

- Hypercharge:  $Y$ 
  - $Y = (B + S + C + B' + T)$
  - $Y = 2(Q - I_3)$
- Weak hypercharge:  $Y_W$ 
  - $Y_W = 2(Q - T_3)$
  - $X + 2Y_W = 5(B - L)$

#### Flavour mixing

- CKM matrix
- PMNS matrix
- Flavour complementarity

# What is flavour physics?



# What is flavour physics?

Fermions ("matter")	Bosons ("forces")
$  \left\{ \begin{array}{l}  \text{Quarks} \\  uuu \quad ccc \quad ttt \\  ddd \quad sss \quad bbb \\  \\  \text{Leptons} \\  e \quad \mu \quad \tau \\  \nu_e \quad \nu_\mu \quad \nu_\tau  \end{array} \right\} \times \left\{ \begin{array}{l}  \text{MATTER} \\  \text{ANTIMATTER}  \end{array} \right\}  $	$  \begin{array}{l}  gggggggg \\  \gamma \\  W^+ \\  W^- \\  Z \\  \\  H  \end{array}  $

# Parameters of the Standard Model

- 3 gauge couplings
- 2 Higgs parameters
- 6 quark masses
- 3 quark mixing angles + 1 phase
- 3 (+3) lepton masses
- (3 lepton mixing angles + 1 phase)

( ) = with Dirac neutrino masses

# Parameters of the Standard Model

- 3 gauge couplings
- 2 Higgs parameters
- 6 quark masses
- 3 quark mixing angles + 1 phase
- 3 (+3) lepton masses
- (3 lepton mixing angles + 1 phase)

CKM matrix

PMNS matrix

( ) = with Dirac neutrino masses

# Parameters of the Standard Model

- 3 gauge couplings
- 2 Higgs parameters
- 6 quark masses
- 3 quark mixing angles + 1 phase
- 3 (+3) lepton masses
- (3 lepton mixing angles + 1 phase)

CKM matrix

PMNS matrix

( ) = with Dirac neutrino masses

FLAVOUR  
PARAMETERS



# Mysteries of flavour physics

- Why are there so many different fermions?
- What is responsible for their organisation into generations / families?
- Why are there 3 generations / families each of quarks and leptons?
- Why are there flavour symmetries?
- What breaks the flavour symmetries?
- What causes matter–antimatter asymmetry?

# Reducing the scope

- Flavour physics includes
  - Neutrinos
  - Charged leptons
  - Kaon physics
  - Charm & beauty physics
  - (Some aspects of) top physics
  
- My focus will be on charm & beauty
  - will touch on others when appropriate

# Heavy quark flavour physics

- Focus in these lectures will be on
  - flavour-changing interactions of charm and beauty quarks
- But quarks feel the strong interaction and hence hadronise
  - various different charmed and beauty hadrons
  - many, many possible decays to different final states
- The hardest part of quark flavour physics is learning the names of all the damned hadrons!
- On the other hand, hadronisation greatly increases the observability of CP violation effects
  - the strong interaction can be seen either as the “**unsung hero**” or the “**villain**” in the story of quark flavour physics

# Why is heavy flavour physics interesting?

- Hope to learn something about the mysteries of the flavour structure of the Standard Model
- CP violation and its connection to the matter–antimatter asymmetry of the Universe
- Discovery potential far beyond the energy frontier via searches for rare or SM forbidden processes

# What breaks the flavour symmetries?

- In the Standard Model, the vacuum expectation value of the Higgs field breaks the electroweak symmetry
- Fermion masses arise from the Yukawa couplings of the quarks and charged leptons to the Higgs field (taking  $m_\nu=0$ )
- The CKM matrix arises from the relative misalignment of the Yukawa matrices for the up- and down-type quarks
- Consequently, the only flavour-changing interactions are the charged current weak interactions
  - no flavour-changing neutral currents (GIM mechanism)
  - not generically true in most extensions of the SM
  - flavour-changing processes provide sensitive tests

# Lepton flavour violation

- Why do we not observe the decay  $\mu \rightarrow e\gamma$ ?
  - exact (but accidental) lepton flavour conservation in the SM with  $m_\nu = 0$
  - SM loop contributions suppressed by  $(m_\nu/m_W)^4$
  - but new physics models tend to induce larger contributions
    - unsuppressed loop contributions
    - generic argument, true in most common models

# The muon to electron gamma (MEG) experiment at PSI

$$\mu^+ \rightarrow e^+ \gamma$$

- positive muons  $\rightarrow$  no muonic atoms
- continuous (DC) muon beam  $\rightarrow$  minimise accidental coincidences

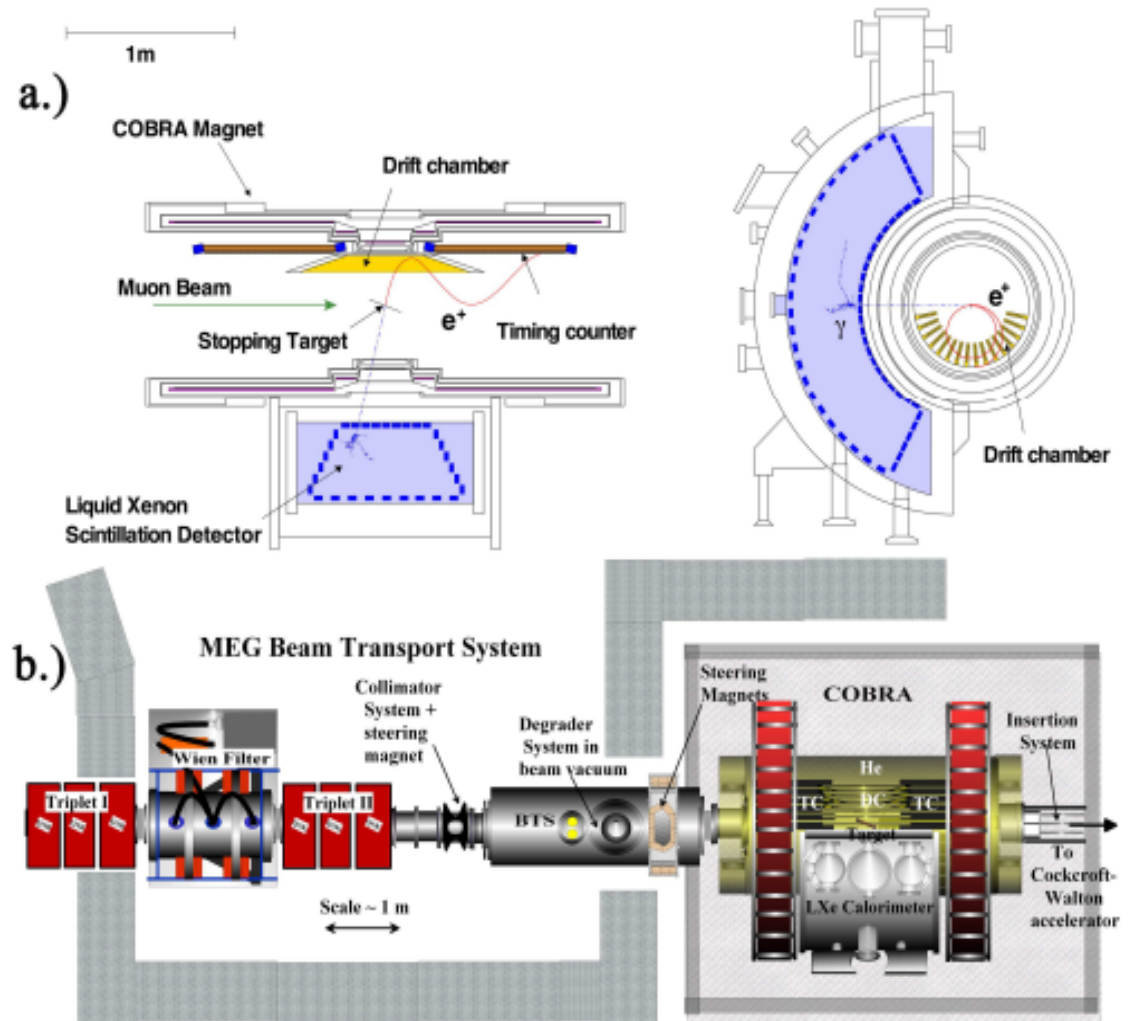
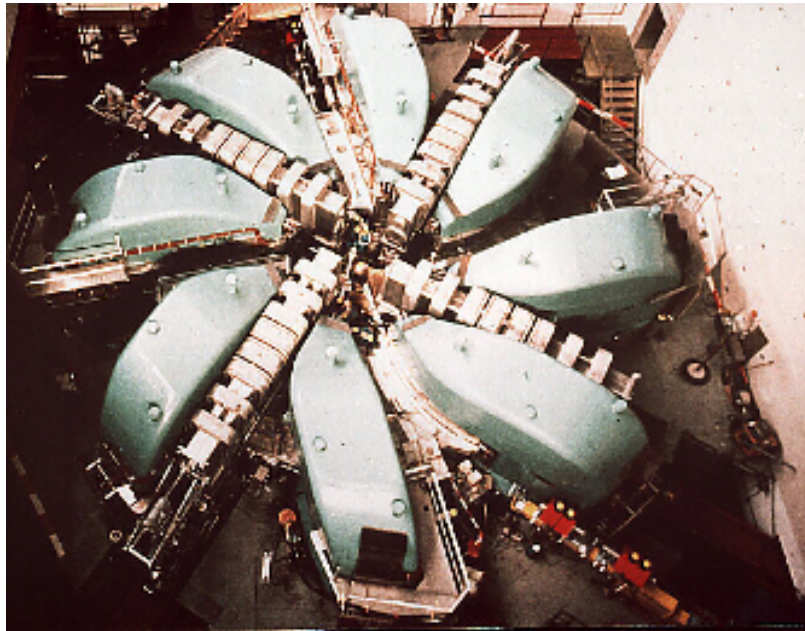

# MEG results

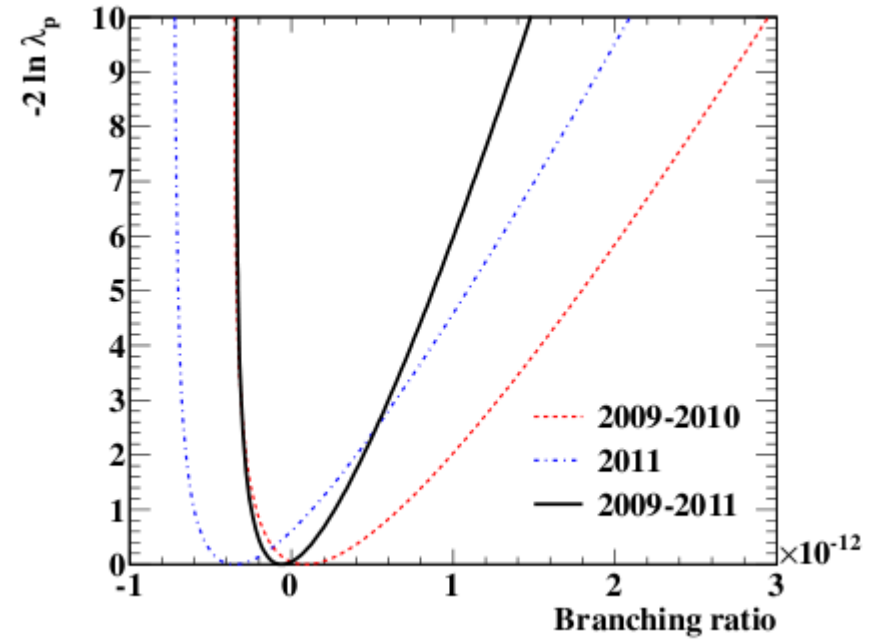
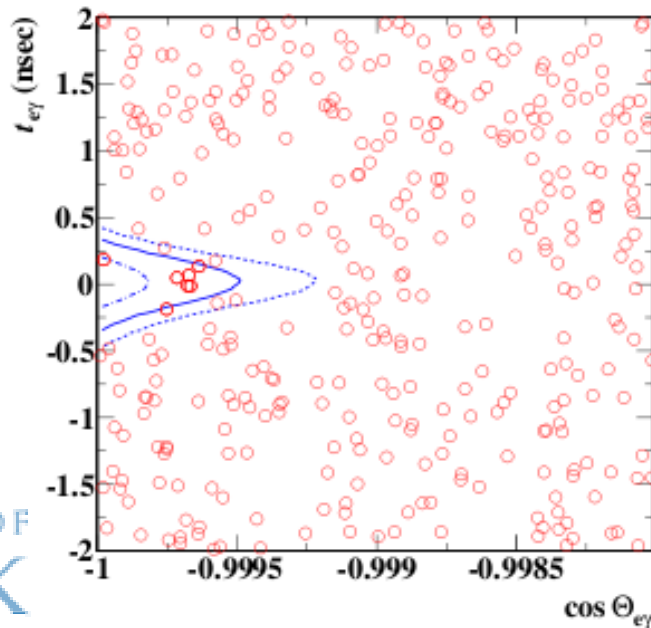
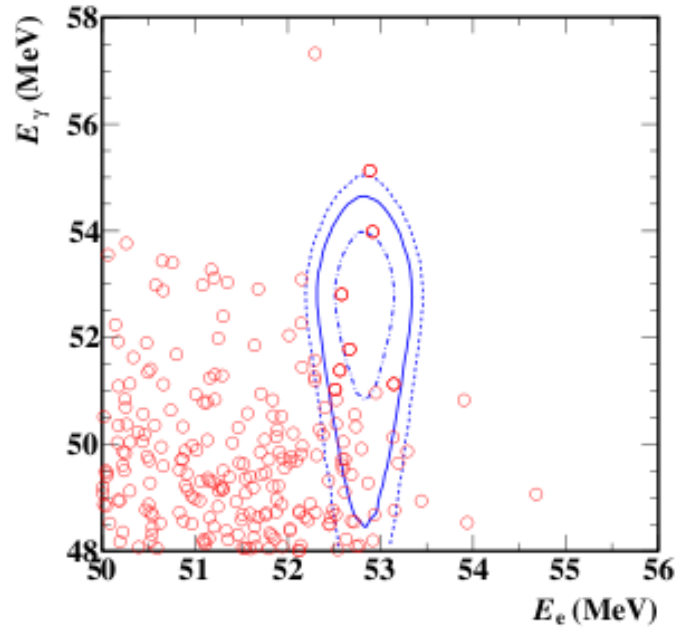

$B(\mu^+ \rightarrow e^+ \gamma) < 5.7 \cdot 10^{-13}$  @ 90% CL  
PRL 110 (2013) 201801



# Prospects for Lepton Flavour Violation

- MEG still analysing data & planning upgrade; also  $\mu \rightarrow eee$
- New generations of  $\mu - e$  conversion experiments
  - COMET at J-PARC; mu2e at FNAL
  - Potential improvements of  $O(10^4) - O(10^6)$  in sensitivities!
- $\tau$  LFV a priority for next generation  $e^+e^-$  flavour factories
  - SuperKEKB/Belle2 at KEK & SuperB in Italy
  - $O(100)$  improvements in luminosity  $\rightarrow O(10) - O(100)$  improvements in sensitivity (depending on background)

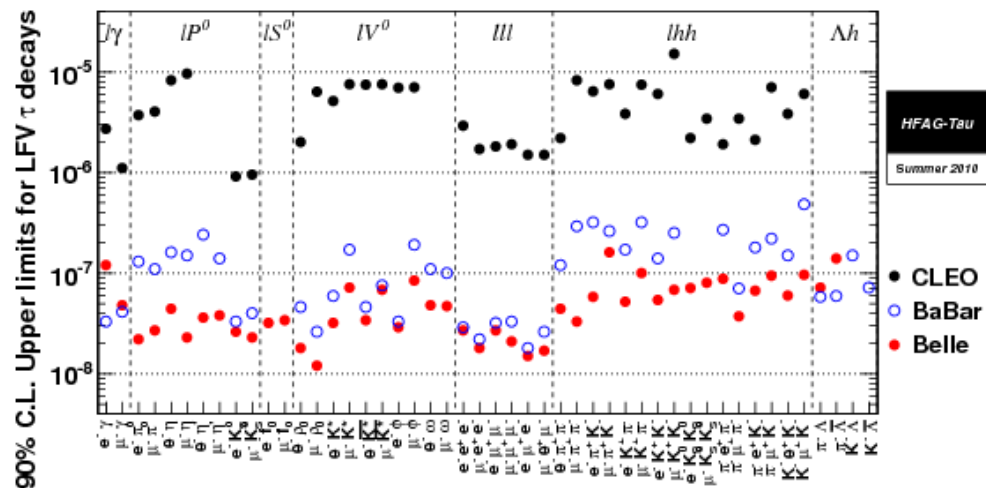

# What causes the difference between matter and antimatter?

- The CKM matrix arises from the relative misalignment of the Yukawa matrices for the up- and down-type quarks

$$V_{CKM} = U_u U_d^+$$

U matrices from diagonalisation of mass matrices

- It is a 3x3 complex **unitary** matrix
  - described by 9 (real) parameters
  - 5 can be absorbed as phase differences between the quark fields
  - 3 can be expressed as (Euler) mixing angles
  - the fourth makes the CKM matrix complex (i.e. gives it a phase)
    - weak interaction couplings differ for quarks and antiquarks
    - CP violation

# The Cabibbo-Kobayashi-Maskawa Quark Mixing Matrix



$$V_{CKM} = \begin{pmatrix} V_{ud} & V_{us} & V_{ub} \\ V_{cd} & V_{cs} & V_{cb} \\ V_{td} & V_{ts} & V_{tb} \end{pmatrix}$$

- A 3x3 unitary matrix
- Described by 4 real parameters – **allows CP violation**
  - PDG (Chau-Keung) parametrisation:  $\theta_{12}, \theta_{23}, \theta_{13}, \delta$
  - Wolfenstein parametrisation:  $\lambda, A, \rho, \eta$
- **Highly predictive**

# Range of CKM phenomena

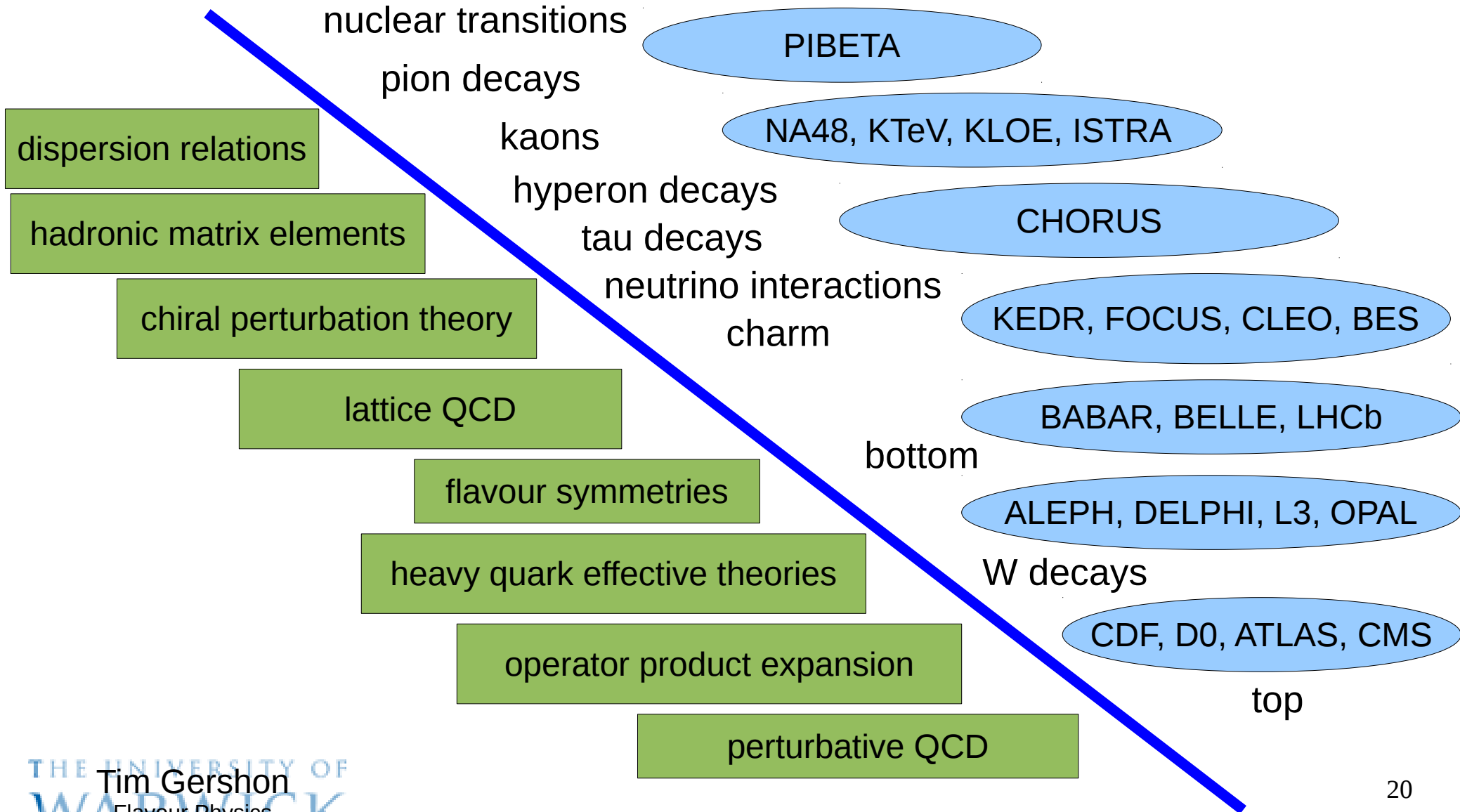

# A brief history of CP violation and Nobel Prizes

- 1964 – Discovery of CP violation in  $K^0$  system  
PRL 13 (1964) 138
- 1973 – Kobayashi and Maskawa propose 3 generations  
Prog.Theor.Phys. 49 (1973) 652
- 1980 – Nobel Prize to Cronin and Fitch

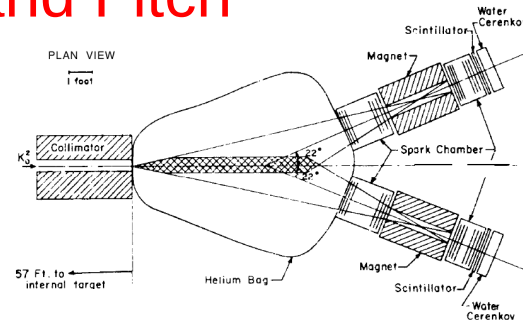

Fig. 1. Plan view of the apparatus as located at the A. G. S.

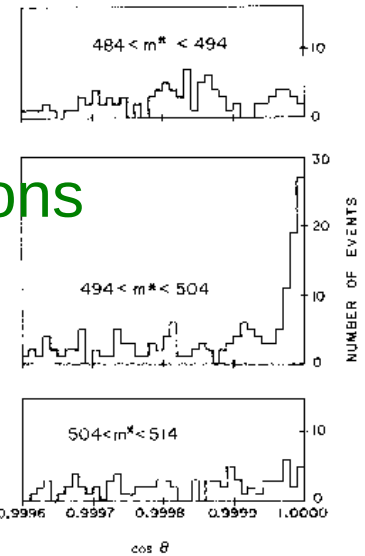
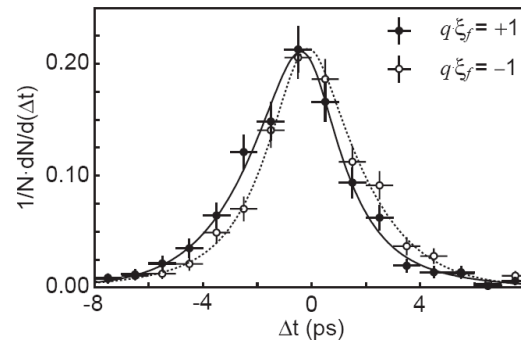
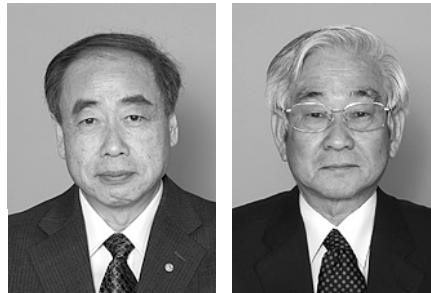
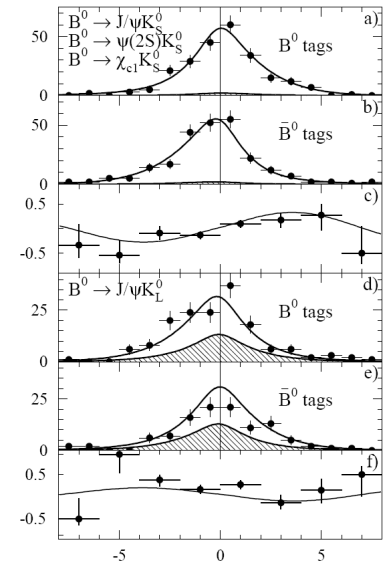

FIG. 3. Angular distribution in three mass ranges for events with  $\cos\theta > 0.9995$ .

- 2001 – Discovery of CP violation in  $B_d$  system
- 2008 – Nobel Prize to Kobayashi and Maskawa



Belle PRL 87 (2001) 091802



BABAR PRL 87 (2001) 091801

# Sakharov conditions

- Proposed by A.Sakharov, 1967
- Necessary for evolution of matter dominated universe, from symmetric initial state
  - (1) baryon number violation
  - (2) C & CP violation
  - (3) thermal inequilibrium
- No significant amounts of antimatter observed
- $\Delta N_B / N_Y = (N(\text{baryon}) - N(\text{antibaryon})) / N_Y \sim 10^{-10}$

# Dirac's prescience

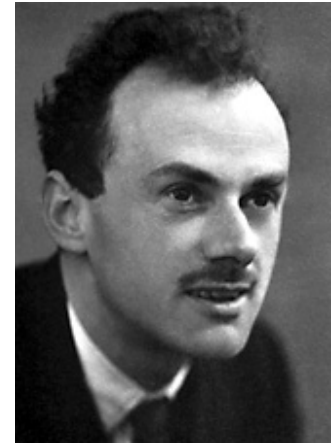

## Concluding words of 1933 Nobel lecture

“If we accept the view of **complete symmetry between positive and negative electric charge** so far as concerns the fundamental laws of Nature, we must regard it rather as an accident that the Earth (and presumably the whole solar system), contains a **preponderance of negative electrons and positive protons**. It is quite possible that for some of the stars it is the other way about, these stars being built up mainly of positrons and negative protons. In fact, there may be half the stars of each kind. **The two kinds of stars would both show exactly the same spectra**, and there would be no way of distinguishing them by present astronomical methods.”

# Digression<sup>3</sup>: Are there antimatter dominated regions of the Universe?

- Possible signals:
  - Photons produced by matter-antimatter annihilation at domain boundaries – not seen
    - Nearby anti-galaxies ruled out
  - Cosmic rays from anti-stars
    - Best prospect: Anti-<sup>4</sup>He nuclei
    - Searches ongoing ...

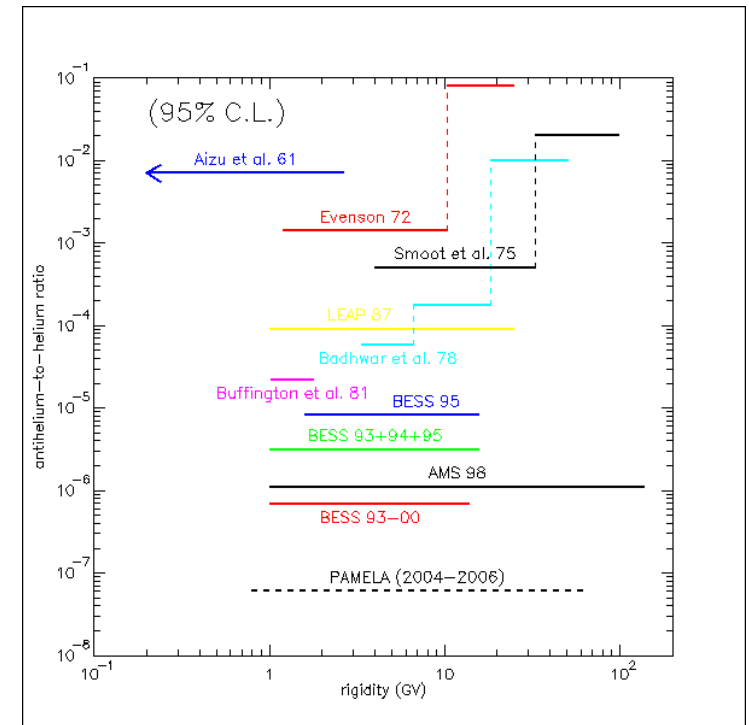



# Searches for astrophysical antimatter

**Alpha Magnetic Spectrometer** Experiment  
on board the **International Space Station**

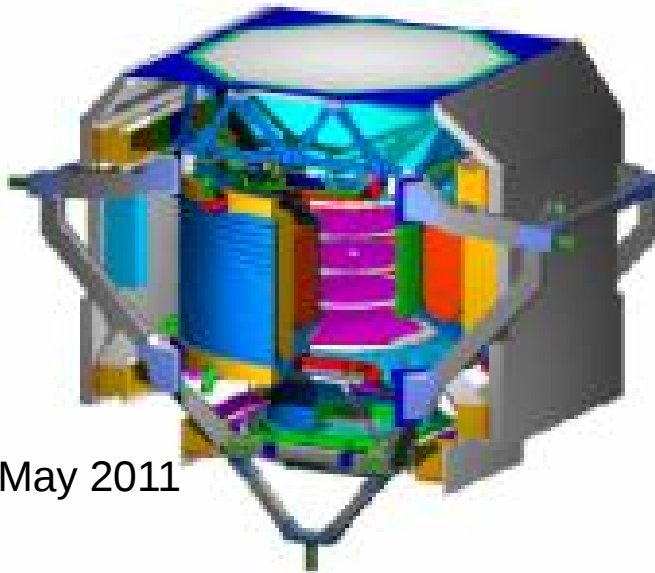
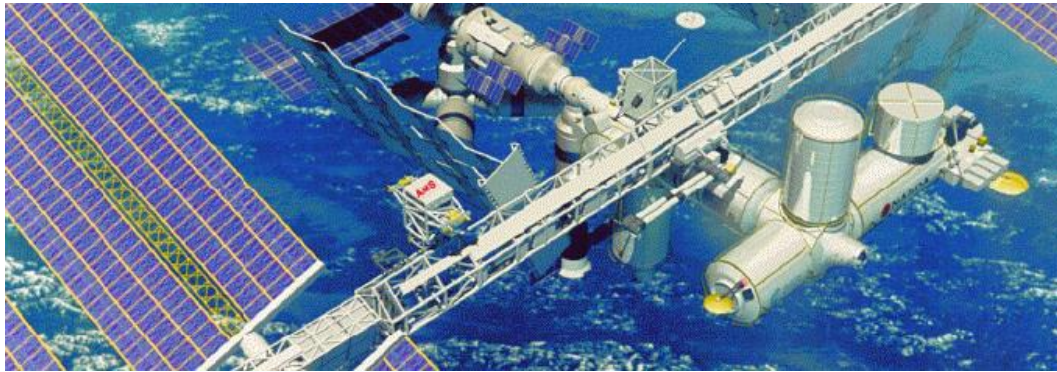

launched 16<sup>th</sup> May 2011

**Payload for AntiMatter Exploration and  
Light-nuclei Astrophysics** Experiment  
on board the **Resurs-DK1** satellite

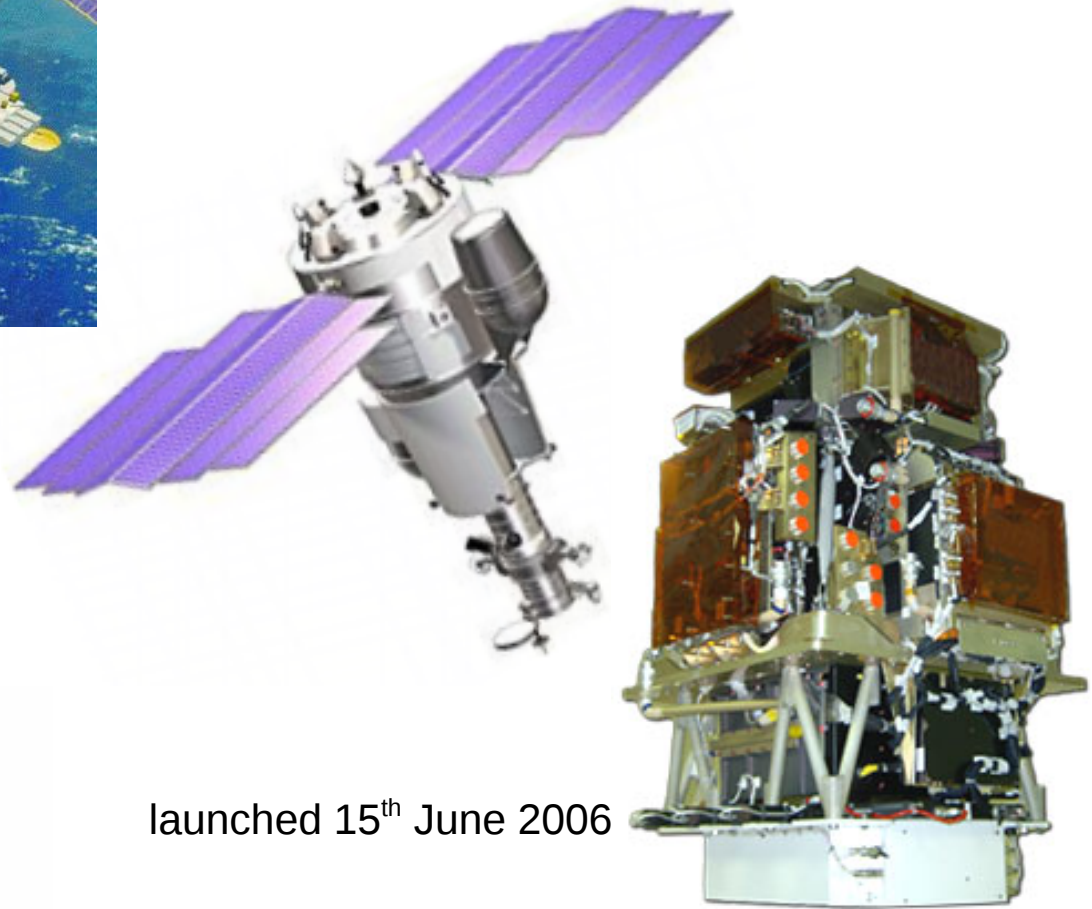

launched 15<sup>th</sup> June 2006

# Dynamic generation of BAU

- Suppose equal amounts of matter ( $X$ ) and antimatter ( $\bar{X}$ )
- $X$  decays to
  - $A$  (baryon number  $N_A$ ) with probability  $p$
  - $B$  (baryon number  $N_B$ ) with probability  $(1-p)$
- $\bar{X}$  decays to
  - $\bar{A}$  (baryon number  $-N_A$ ) with probability  $\bar{p}$
  - $\bar{B}$  (baryon number  $-N_B$ ) with probability  $(1-\bar{p})$
- Generated baryon asymmetry:
  - $\Delta N_{\text{TOT}} = N_A p + N_B (1-p) - N_A \bar{p} - N_B (1-\bar{p}) = (p - \bar{p}) (N_A - N_B)$
  - $\Delta N_{\text{TOT}} \neq 0$  requires  $p \neq \bar{p}$  &  $N_A \neq N_B$

# CP violation and the BAU

- We can estimate the magnitude of the baryon asymmetry of the Universe caused by KM CP violation

$$\frac{n_B - n_{\bar{B}}}{n_\gamma} \approx \frac{n_B}{n_\gamma} \sim \frac{J \times P_u \times P_d}{M^{12}} \leftarrow \text{N.B. Vanishes for degenerate masses}$$

$$J = \cos(\theta_{12}) \cos(\theta_{23}) \cos^2(\theta_{13}) \sin(\theta_{12}) \sin(\theta_{23}) \sin(\theta_{13}) \sin(\delta)$$

$$P_u = (m_t^2 - m_c^2)(m_t^2 - m_u^2)(m_c^2 - m_u^2)$$

$$P_d = (m_b^2 - m_s^2)(m_b^2 - m_d^2)(m_s^2 - m_d^2)$$

PRL 55 (1985) 1039

- The **Jarlskog** parameter J is a parametrization invariant measure of CP violation in the quark sector:  $J \sim O(10^{-5})$
- The mass scale M can be taken to be the electroweak scale  $O(100 \text{ GeV})$
- This gives an asymmetry  $O(10^{-17})$ 
  - **much much below** the observed value of  $O(10^{-10})$

# We need more CP violation!

- Widely accepted that SM CPV insufficient to explain observed baryon asymmetry of the Universe
- To create a larger asymmetry, require
  - new sources of CP violation
  - that occur at high energy scales
- Where might we find it?
  - lepton sector: CP violation in neutrino oscillations
  - quark sector: discrepancies with KM predictions
  - gauge sector, extra dimensions, other new physics: precision measurements of flavour observables are generically sensitive to additions to the Standard Model

# The neutrino sector

- Enticing possibility that neutrinos may be Majorana particles
  - provides connection with high energy scale (seesaw)
  - CP violation in leptons could be transferred to baryon sector (via B-L conserving processes)
- Requires
  - Determination of PMNS matrix
    - All mixing angles and CP phase must be non-zero
    - All mixing angles now measured; “only”  $\delta_{CP}$  to go
  - Experimental proof that neutrinos are Majorana
- Hope for answers to these questions within LHC era

# Flavour for new physics discoveries

# A lesson from history

- New physics shows up at precision frontier before energy frontier
  - GIM mechanism before discovery of charm
  - CP violation / CKM before discovery of bottom & top
  - Neutral currents before discovery of Z
- Particularly sensitive – loop processes
  - Standard Model contributions suppressed / absent
  - flavour changing neutral currents (rare decays)
  - CP violation
  - lepton flavour / number violation / lepton universality

# Neutral meson oscillations

- We have flavour eigenstates  $M^0$  and  $\bar{M}^0$ 
  - $M^0$  can be  $K^0$  ( $\bar{s}d$ ),  $D^0$  ( $c\bar{u}$ ),  $B_d^0$  ( $\bar{b}d$ ) or  $B_s^0$  ( $\bar{b}s$ )
- These can mix into each other
  - via short-distance or long-distance processes
- Time-dependent Schrödinger eqn.

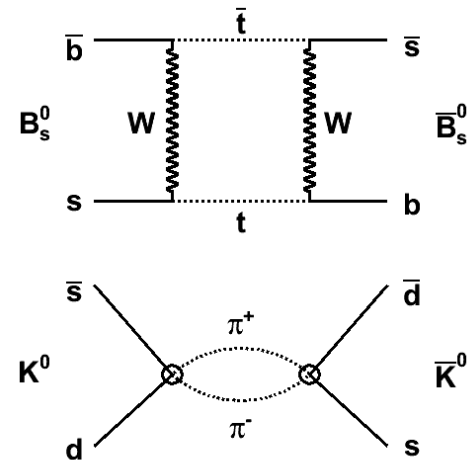

$$i \frac{\partial}{\partial t} \begin{pmatrix} M^0 \\ \bar{M}^0 \end{pmatrix} = H \begin{pmatrix} M^0 \\ \bar{M}^0 \end{pmatrix} = \left( M - \frac{i}{2} \Gamma \right) \begin{pmatrix} M^0 \\ \bar{M}^0 \end{pmatrix}$$

– H is Hamiltonian; M and  $\Gamma$  are 2x2 Hermitian matrices

- CPT theorem:  $M_{11} = M_{22}$  &  $\Gamma_{11} = \Gamma_{22}$



# Solving the Schrödinger equation

- Physical states: eigenstates of effective Hamiltonian

$$M_{S,L} = p M^0 \pm q \bar{M}^0$$

$p$  &  $q$  complex coefficients  
that satisfy  $|p|^2 + |q|^2 = 1$

label as either S,L (short-, long-lived) or L,H (light, heavy) depending on values of  $\Delta m$  &  $\Delta\Gamma$  (labels 1,2 usually reserved for CP eigenstates)

– CP conserved if physical states = CP eigenstates ( $|q/p| = 1$ )

- Eigenvalues

$$\lambda_{S,L} = m_{S,L} - \frac{1}{2}i\Gamma_{S,L} = (M_{11} - \frac{1}{2}i\Gamma_{11}) \pm (q/p)(M_{12} - \frac{1}{2}i\Gamma_{12})$$

$$\Delta m = m_L - m_S \quad \Delta\Gamma = \Gamma_S - \Gamma_L$$

$$(\Delta m)^2 - \frac{1}{4}(\Delta\Gamma)^2 = 4(|M_{12}|^2 + \frac{1}{4}|\Gamma_{12}|^2)$$

$$\Delta m \Delta\Gamma = 4\text{Re}(M_{12} \Gamma_{12}^*)$$

$$(q/p)^2 = (M_{12}^* - \frac{1}{2}i\Gamma_{12}^*) / (M_{12} - \frac{1}{2}i\Gamma_{12})$$

# Simplistic picture of mixing parameters

- $\Delta m$ : value depends on rate of mixing diagram

- together with various other constants ...

$$\Delta m_d = \frac{G_F^2}{6\pi^2} m_W^2 \eta_b S(x_t) m_{B_d} f_{B_d}^2 \hat{B}_{B_d} |V_{tb}|^2 |V_{td}|^2$$

- that can be made to cancel in ratios

remaining factors can be obtained from lattice QCD calculations

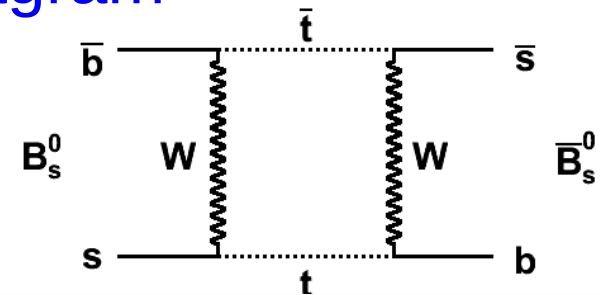

$$\frac{\Delta m_d}{\Delta m_s} = \frac{m_{B_d} f_{B_d}^2 \hat{B}_{B_d} |V_{td}|^2}{m_{B_s} f_{B_s}^2 \hat{B}_{B_s} |V_{ts}|^2}$$

- $\Delta\Gamma$ : value depends on widths of decays into common final states (CP-eigenstates)

- large for  $K^0$ , small for  $D^0$  &  $B_d^0$

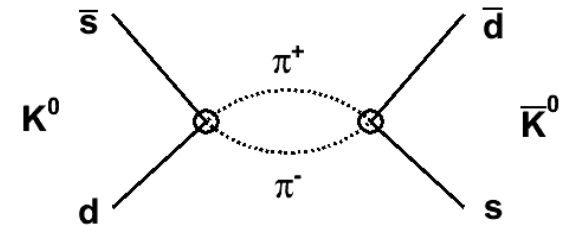

- $q/p \approx 1$  if  $\arg(\Gamma_{12}/M_{12}) \approx 0$  ( $|q/p| \approx 1$  if  $M_{12} \ll \Gamma_{12}$  or  $M_{12} \gg \Gamma_{12}$ )

- CP violation in mixing when  $|q/p| \neq 1$

$$\left( \epsilon = \frac{p-q}{p+q} \neq 0 \right)$$

# Simplistic picture of mixing parameters

	$\Delta m$ ( $x = \Delta m/\Gamma$ )	$\Delta\Gamma$ ( $y = \Delta\Gamma/2\Gamma$ )	$q/p$ ( $\varepsilon = (p-q)/(p+q)$ )
$K^0$	large $\sim 500$	$\sim$ maximal $\sim 1$	small $2 \times 10^{-3}$
$D^0$	small $(0.41 \pm 0.15)\%$	small $(0.63 \pm 0.08)\%$	small $0.03 \pm 0.05$
$B^0$	medium $0.775 \pm 0.006$	small $0.001 \pm 0.005$	small $-0.0007 \pm 0.0009$
$B_s^0$	large $26.79 \pm 0.08$	medium $0.061 \pm 0.005$	small $-0.0038 \pm 0.0021$

# Simplistic picture of mixing parameters

	$\Delta m$ ( $x = \Delta m/\Gamma$ )	$\Delta\Gamma$ ( $y = \Delta\Gamma/2\Gamma$ )	$q/p$ ( $\varepsilon = (p-q)/(p+q)$ )
$K^0$	large $\sim 500$	$\sim$ maximal $\sim 1$	small $2 \times 10^{-3}$
$D^0$	small $(0.41 \pm 0.15)\%$	small $(0.63 \pm 0.08)\%$	small $0.03 \pm 0.05$
$B^0$	medium $0.775 \pm 0.006$	small $0.001 \pm 0.005$	small $-0.0007 \pm 0.0009$
$B_s^0$	large $26.79 \pm 0.08$	medium $0.061 \pm 0.005$	small $-0.0038 \pm 0.0021$

well-measured only  
recently (see later)

More precise  
measurements needed  
(SM prediction well known)

# Constraints on NP from mixing

- All measurements of  $\Delta m$  &  $\Delta \Gamma$  consistent with SM
  - $K^0, D^0, B_d^0$  and  $B_s^0$
- This means  $|A_{NP}| < |A_{SM}|$  where  $\mathcal{A}_{SM}^{\Delta F=2} \approx \frac{G_F^2 m_t^2}{16\pi^2} (V_{ti}^* V_{tj})^2 \times \langle \bar{M} | (\bar{Q}_{Li} \gamma^\mu Q_{Lj})^2 | M \rangle \times F \left( \frac{M_W^2}{m_t^2} \right)$
- Express NP as perturbation to the SM Lagrangian
  - couplings  $c_i$  and scale  $\Lambda > m_W$   $\mathcal{L}_{\text{eff}} = \mathcal{L}_{\text{SM}} + \sum \frac{c_i^{(d)}}{\Lambda^{(d-4)}} O_i^{(d)}(\text{SM fields})$
- For example, SM like (left-handed) operators  $\Delta \mathcal{L}^{\Delta F=2} = \sum_{i \neq j} \frac{c_{ij}}{\Lambda^2} (\bar{Q}_{Li} \gamma^\mu Q_{Lj})^2$

Ann.Rev.Nucl.Part.Sci.  
60 (2010) 355  
arXiv:1002.0900

Operator	Bounds on $\Lambda$ in TeV ( $c_{ij} = 1$ )		Bounds on $c_{ij}$ ( $\Lambda = 1$ TeV)		Observables
	Re	Im	Re	Im	
$(\bar{s}_L \gamma^\mu d_L)^2$	$9.8 \times 10^2$	$1.6 \times 10^4$	$9.0 \times 10^{-7}$	$3.4 \times 10^{-9}$	$\Delta m_K; \epsilon_K$
$(\bar{s}_R d_L)(\bar{s}_L d_R)$	$1.8 \times 10^4$	$3.2 \times 10^5$	$6.9 \times 10^{-9}$	$2.6 \times 10^{-11}$	$\Delta m_K; \epsilon_K$
$(\bar{c}_L \gamma^\mu u_L)^2$	$1.2 \times 10^3$	$2.9 \times 10^3$	$5.6 \times 10^{-7}$	$1.0 \times 10^{-7}$	$\Delta m_D;  q/p , \phi_D$
$(\bar{c}_R u_L)(\bar{c}_L u_R)$	$6.2 \times 10^3$	$1.5 \times 10^4$	$5.7 \times 10^{-8}$	$1.1 \times 10^{-8}$	$\Delta m_D;  q/p , \phi_D$
$(\bar{b}_L \gamma^\mu d_L)^2$	$5.1 \times 10^2$	$9.3 \times 10^2$	$3.3 \times 10^{-6}$	$1.0 \times 10^{-6}$	$\Delta m_{B_d}; S_{\psi K_S}$
$(\bar{b}_R d_L)(\bar{b}_L d_R)$	$1.9 \times 10^3$	$3.6 \times 10^3$	$5.6 \times 10^{-7}$	$1.7 \times 10^{-7}$	$\Delta m_{B_d}; S_{\psi K_S}$
$(\bar{b}_L \gamma^\mu s_L)^2$		$1.1 \times 10^2$		$7.6 \times 10^{-5}$	$\Delta m_{B_s}$
$(\bar{b}_R s_L)(\bar{b}_L s_R)$		$3.7 \times 10^2$		$1.3 \times 10^{-5}$	$\Delta m_{B_s}$

# Same table but bigger ...

Operator	Bounds on $\Lambda$ in TeV ( $c_{ij} = 1$ )		Bounds on $c_{ij}$ ( $\Lambda = 1$ TeV)		Observables
	Re	Im	Re	Im	
$(\bar{s}_L \gamma^\mu d_L)^2$	$9.8 \times 10^2$	$1.6 \times 10^4$	$9.0 \times 10^{-7}$	$3.4 \times 10^{-9}$	$\Delta m_K; \epsilon_K$
$(\bar{s}_R d_L)(\bar{s}_L d_R)$	$1.8 \times 10^4$	$3.2 \times 10^5$	$6.9 \times 10^{-9}$	$2.6 \times 10^{-11}$	$\Delta m_K; \epsilon_K$
$(\bar{c}_L \gamma^\mu u_L)^2$	$1.2 \times 10^3$	$2.9 \times 10^3$	$5.6 \times 10^{-7}$	$1.0 \times 10^{-7}$	$\Delta m_D;  q/p , \phi_D$
$(\bar{c}_R u_L)(\bar{c}_L u_R)$	$6.2 \times 10^3$	$1.5 \times 10^4$	$5.7 \times 10^{-8}$	$1.1 \times 10^{-8}$	$\Delta m_D;  q/p , \phi_D$
$(\bar{b}_L \gamma^\mu d_L)^2$	$5.1 \times 10^2$	$9.3 \times 10^2$	$3.3 \times 10^{-6}$	$1.0 \times 10^{-6}$	$\Delta m_{B_d}; S_{\psi K_S}$
$(\bar{b}_R d_L)(\bar{b}_L d_R)$	$1.9 \times 10^3$	$3.6 \times 10^3$	$5.6 \times 10^{-7}$	$1.7 \times 10^{-7}$	$\Delta m_{B_d}; S_{\psi K_S}$
$(\bar{b}_L \gamma^\mu s_L)^2$		$1.1 \times 10^2$		$7.6 \times 10^{-5}$	$\Delta m_{B_s}$
$(\bar{b}_R s_L)(\bar{b}_L s_R)$		$3.7 \times 10^2$		$1.3 \times 10^{-5}$	$\Delta m_{B_s}$

# Similar story – but including more (& more up-to-date) inputs, and in pictures

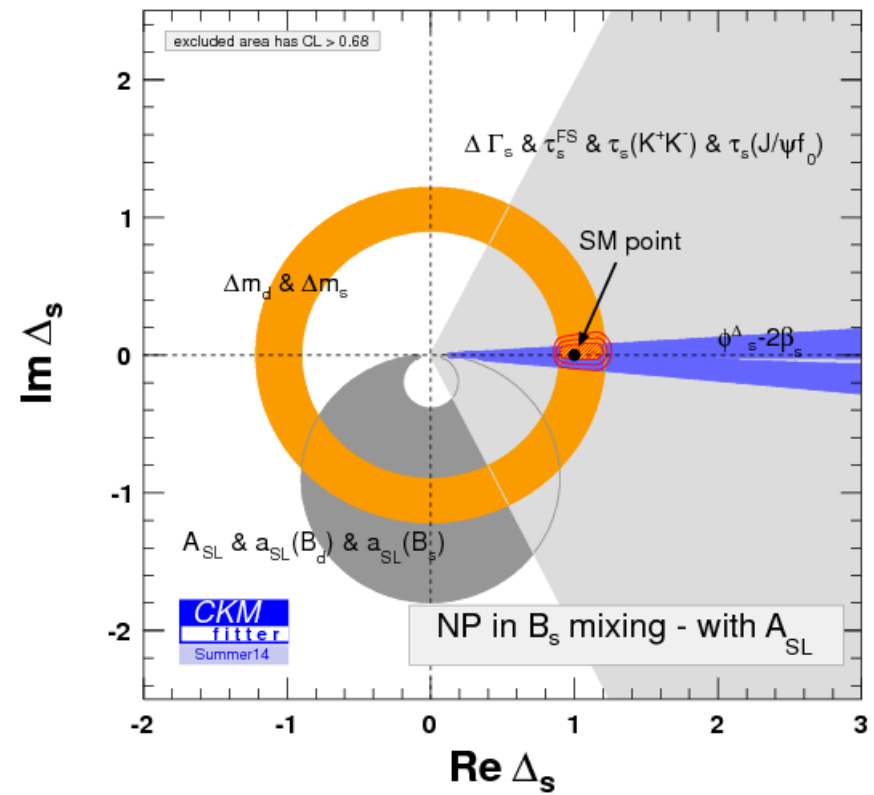
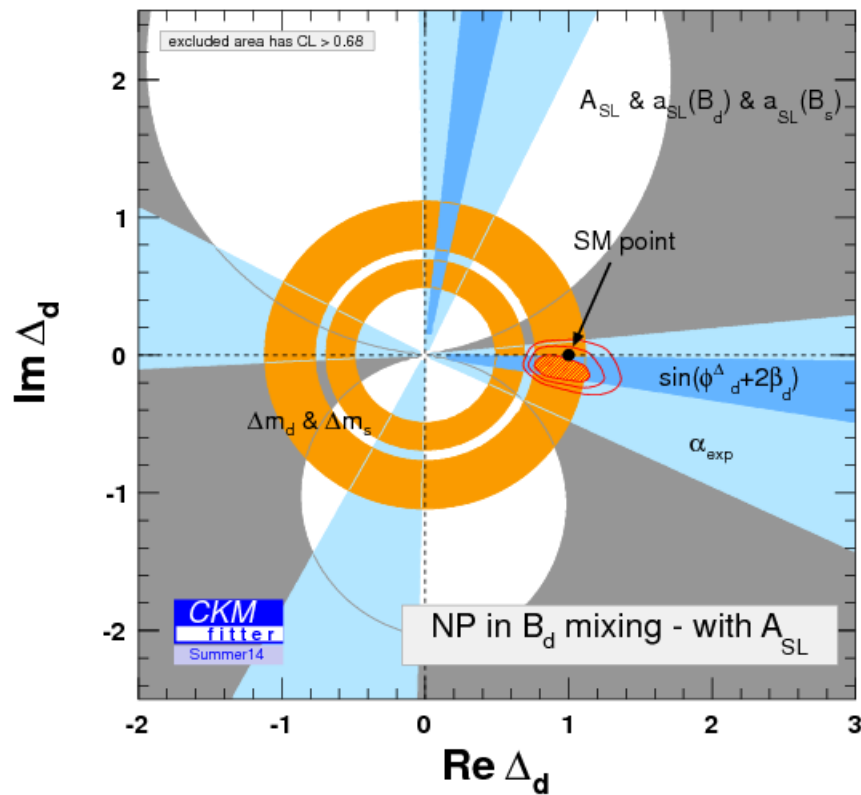

arXiv:1501.05013

# New Physics Flavour Problem

- Limits on NP scale at least 100 TeV for generic couplings
  - model-independent argument, also for rare decays
- But we need NP at the  $\sim$ TeV scale to solve the hierarchy problem (and to provide DM candidate, etc.)
- So we need NP flavour-changing couplings to be small
- Why?
  - minimal flavour violation?
    - perfect alignment of flavour violation in NP and SM
  - some other approximate symmetry?
  - flavour structure tells us about physics at very high scales
- There are still important observables that are not yet well-tested

NPB 645 (2002) 155



# Like-sign dimuon asymmetry

- Semileptonic decays are flavour-specific
- B mesons are produced in  $B\bar{B}$  pairs
- Like-sign leptons arise if one of  $B\bar{B}$  pair mixes before decaying
- If no CP violation in mixing  $N(++)=N(--)$

Some hints of non-SM effects

Driven by inclusive measurements from D0

Improved measurements needed

