

Flavour Physics in the LHC Era

Lecture 1 of 2

Tim Gershon
University of Warwick & CERN

LNFS 2012

10th May 2012



XVI FRASCATI SPRING SCHOOL
"BRUNO TOUSCHEK"

IN NUCLEAR SUBNUCLEAR AND ASTROPARTICLE PHYSICS

& 3rd Young Researchers Workshop:
"Physics Challenges in the LHC Era"

INFN
Istituto Nazionale
di Fisica Nucleare
Laboratori Nazionali di Frascati

LNF, MAY 7th - 11th, 2012
FRASCATI (Italy)

Contents

- **Today**
 - Definitions of “flavour physics” and “the LHC era”
 - Why is flavour physics interesting?
 - What do we know about it as of today?
- **Tomorrow**
 - What do we hope to learn from current and future heavy flavour experiments?

What is the LHC era?

Probably already out-of-date

LHC schedule

New rough draft 10 year plan

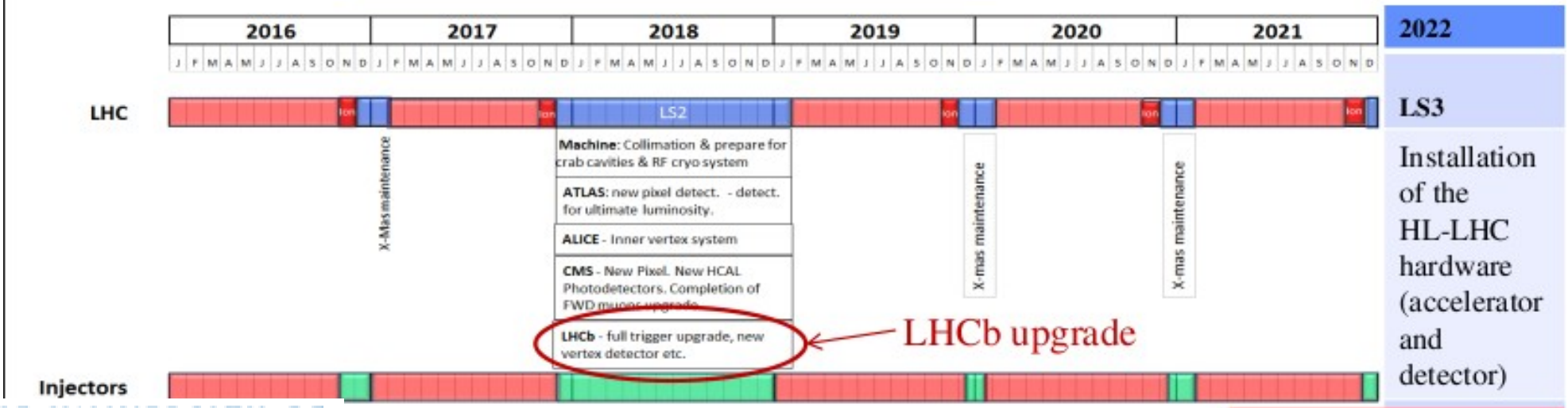
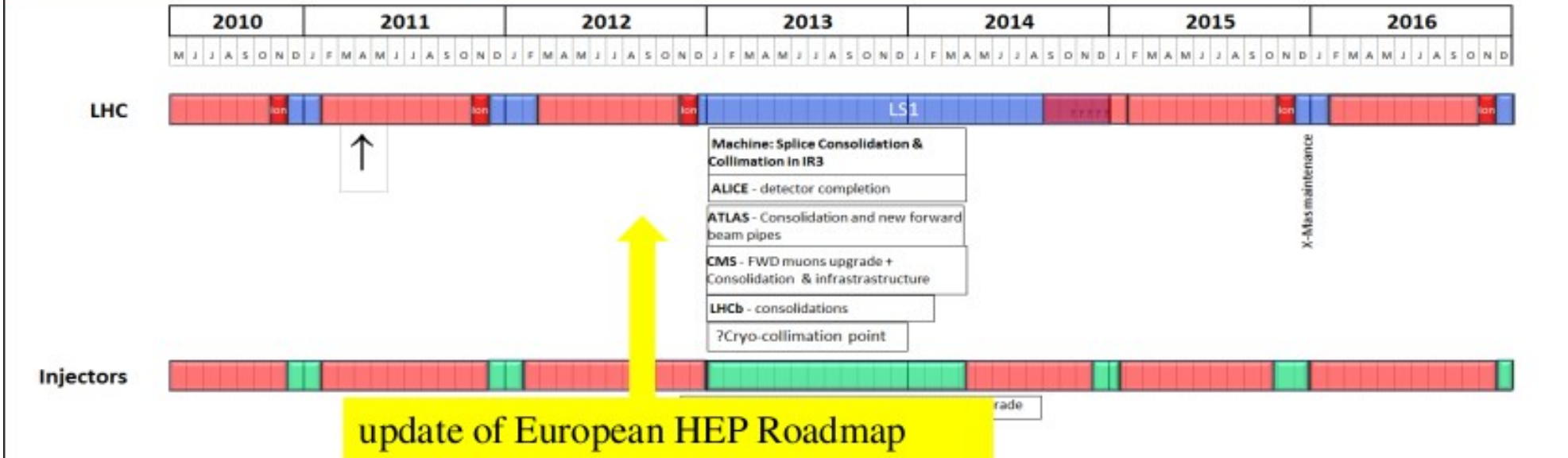

... it is the foreseeable future!

What is flavour physics?

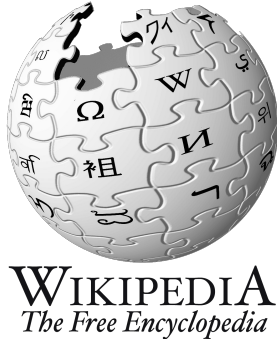

Flavour (particle physics)

From Wikipedia, the free encyclopedia

In [particle physics](#), **flavour** or **flavor** is a [quantum number](#) of [elementary particles](#). In [quantum chromodynamics](#), flavour is a global symmetry. In the [electroweak theory](#), on the other hand, this symmetry is broken, and flavour-changing processes exist, such as quark decay or [neutrino oscillations](#).

“The term flavor was first used in particle physics in the context of the quark model of hadrons. It was coined in 1971 by Murray Gell-Mann and his student at the time, Harald Fritzsch, at a Baskin-Robbins ice-cream store in Pasadena. Just as ice cream has both color and flavor so do quarks.”

RMP 81 (2009) 1887

Flavour in [particle physics](#)

Flavour [quantum numbers](#):

- Baryon number: B
- Lepton number: L
- Strangeness: S
- Charm: C
- Bottomness: B'
- Topness: T
- Isospin: I or I_3
- Weak isospin: T or T_3
- Electric charge: Q
- X-charge: X

Combinations:

- Hypercharge: Y
 - $Y = (B + S + C + B' + T)$
 - $Y = 2(Q - I_3)$
- Weak hypercharge: Y_W
 - $Y_W = 2(Q - T_3)$
 - $X + 2Y_W = 5(B - L)$

Flavour mixing

- CKM matrix
- PMNS matrix
- Flavour complementarity

What is flavour physics?

Fermions
("matter")

Bosons
("forces")

$$\left\{ \begin{array}{l} \text{Quarks} \\ uuu \quad ccc \quad ttt \\ ddd \quad sss \quad bbb \\ \\ \text{Leptons} \\ e \quad \mu \quad \tau \\ \nu_e \quad \nu_\mu \quad \nu_\tau \end{array} \right\} \times \left\{ \begin{array}{l} \text{MATTER} \\ \text{ANTIMATTER} \end{array} \right\}$$

$gggggggg$

γ

W^+

W^-

Z

H

Parameters of the Standard Model

- 3 gauge couplings
- 2 Higgs parameters
- 6 quark masses
- 3 quark mixing angles + 1 phase
- 3 (+3) lepton masses
- (3 lepton mixing angles + 1 phase)

() = with Dirac neutrino masses

Parameters of the Standard Model

- 3 gauge couplings
- 2 Higgs parameters
- 6 quark masses
- 3 quark mixing angles + 1 phase
- 3 (+3) lepton masses
- (3 lepton mixing angles + 1 phase)

CKM matrix

PMNS matrix

() = with Dirac neutrino masses

Parameters of the Standard Model

- 3 gauge couplings
- 2 Higgs parameters
- 6 quark masses
- 3 quark mixing angles + 1 phase
- 3 (+3) lepton masses
- (3 lepton mixing angles + 1 phase)

CKM matrix

PMNS matrix

() = with Dirac neutrino masses

FLAVOUR
PARAMETERS

Mysteries of flavour physics

- Why are there so many different fermions?
- What is responsible for their organisation into generations / families?
- Why are there 3 generations / families each of quarks and leptons?
- Why are there flavour symmetries?
- What breaks the flavour symmetries?
- What causes matter–antimatter asymmetry?

Mysteries of flavour physics

- Why are there so many different fermions?
- What is responsible for their organisation into generations / families?
- Why are there 3 generations / families each of quarks and leptons?
- Why are there flavour symmetries?
- What breaks the flavour symmetries?
- What causes matter–antimatter asymmetry?

Reducing the scope

- Flavour physics includes
 - Neutrinos
 - Charged leptons
 - Kaon physics
 - Charm & beauty physics
 - (Some aspects of) top physics
- My focus will be on charm & beauty
 - will touch on others when appropriate

Heavy quark flavour physics

- Focus in these lectures will be on
 - flavour-changing interactions of charm and beauty quarks
- But quarks feel the strong interaction and hence hadronise
 - various different charmed and beauty hadrons
 - many, many possible decays to different final states
- The hardest part of quark flavour physics is learning the names of all the damned hadrons!
- On the other hand, hadronisation greatly increases the observability of CP violation effects
 - the strong interaction can be seen either as the “**unsung hero**” or the “**villain**” in the story of quark flavour physics

Why is heavy flavour physics interesting?

- Hope to learn something about the mysteries of the flavour structure of the Standard Model
- CP violation and its connection to the matter–antimatter asymmetry of the Universe
- Discovery potential far beyond the energy frontier via searches for rare or SM forbidden processes

What breaks the flavour symmetries?

- In the Standard Model, the vacuum expectation value of the Higgs field breaks the electroweak symmetry
- Fermion masses arise from the Yukawa couplings of the quarks and charged leptons to the Higgs field (taking $m_\nu=0$)
- The CKM matrix arises from the relative misalignment of the Yukawa matrices for the up- and down-type quarks
- Consequently, the only flavour-changing interactions are the charged current weak interactions
 - no flavour-changing neutral currents (GIM mechanism)
 - not generically true in most extensions of the SM
 - flavour-changing processes provide sensitive tests

Lepton flavour violation

- Why do we not observe the decay $\mu \rightarrow e\gamma$?
 - exact (but accidental) lepton flavour conservation in the SM with $m_\nu=0$
 - SM loop contributions suppressed by $(m_\nu/m_W)^4$
 - but new physics models tend to induce larger contributions
 - unsuppressed loop contributions
 - generic argument, also true in most common models

The muon to electron gamma (MEG) experiment at PSI

$$\mu^+ \rightarrow e^+ \gamma$$

- positive muons \rightarrow no muonic atoms
- continuous (DC) muon beam \rightarrow minimise accidental coincidences

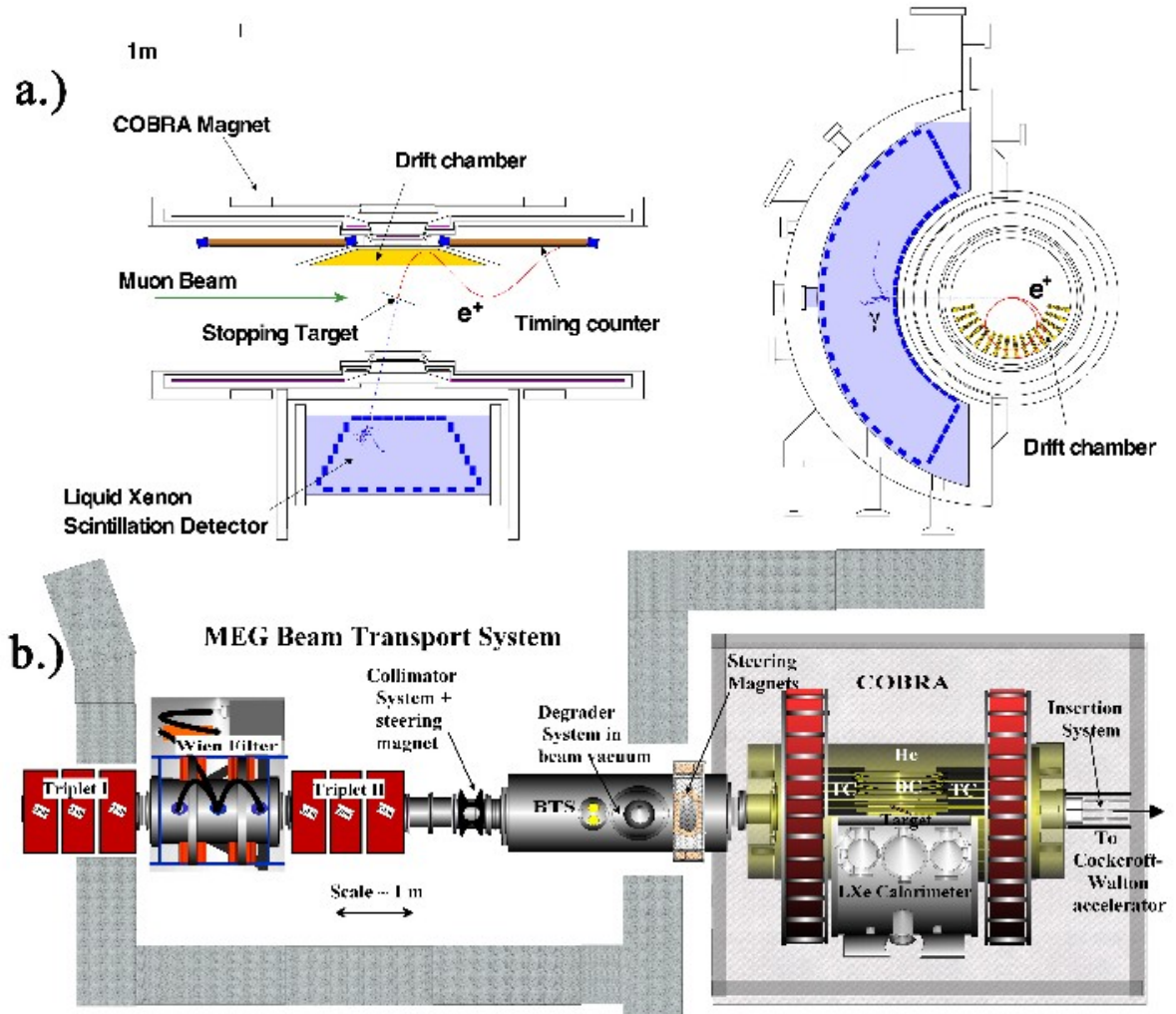
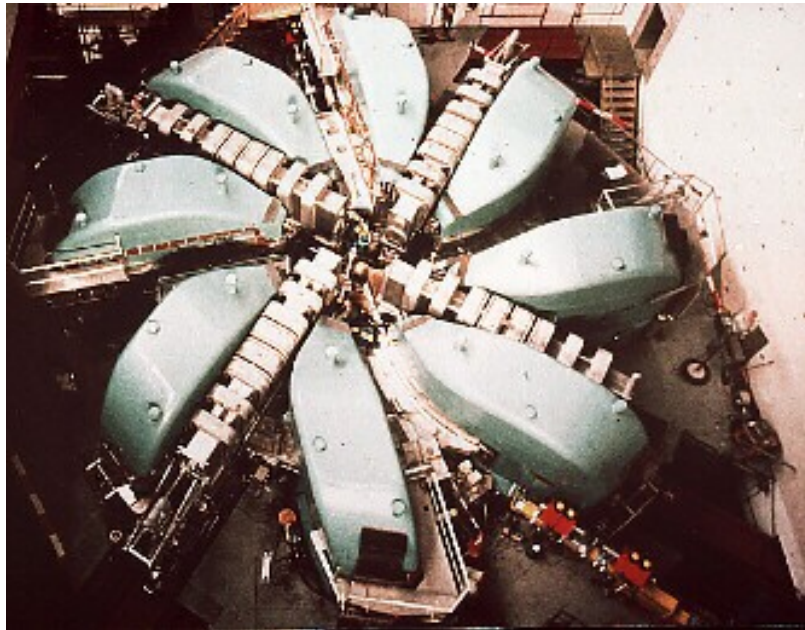

MEG results

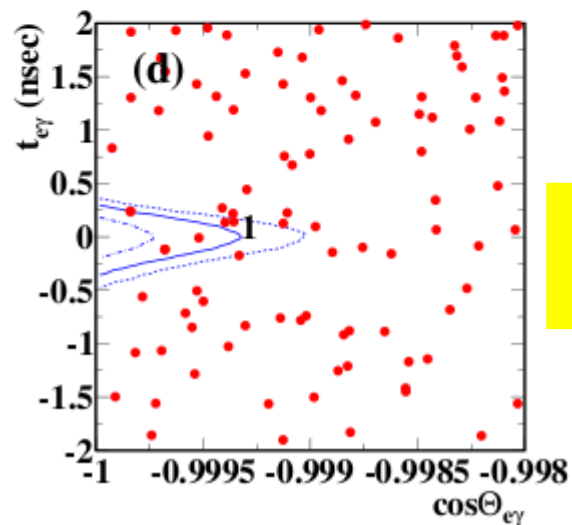
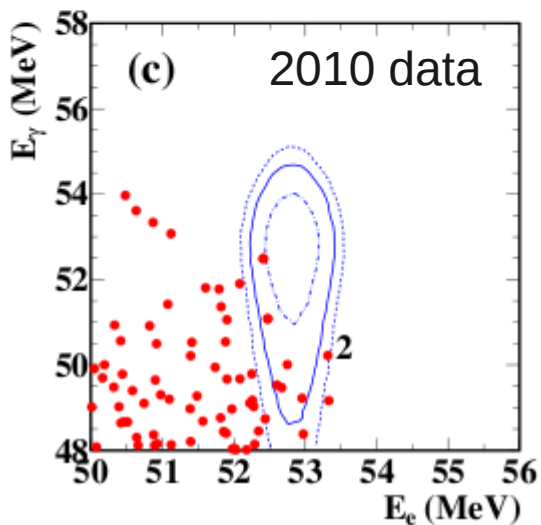
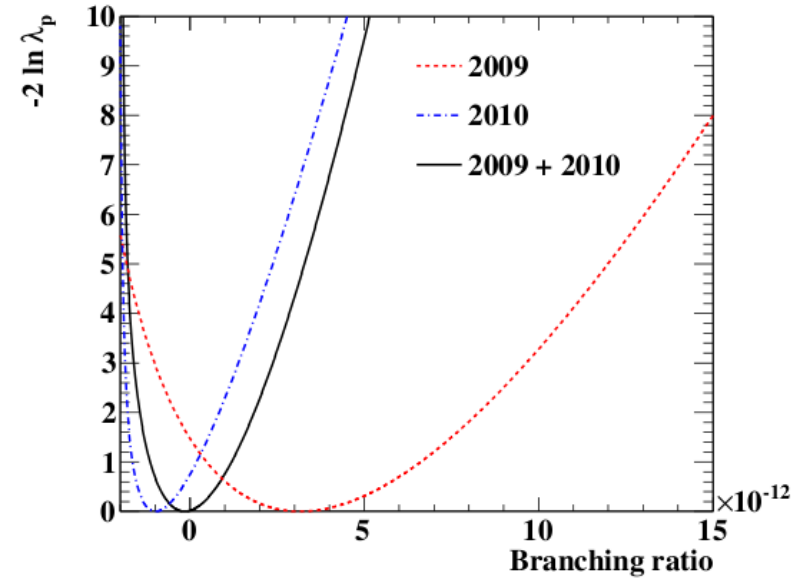
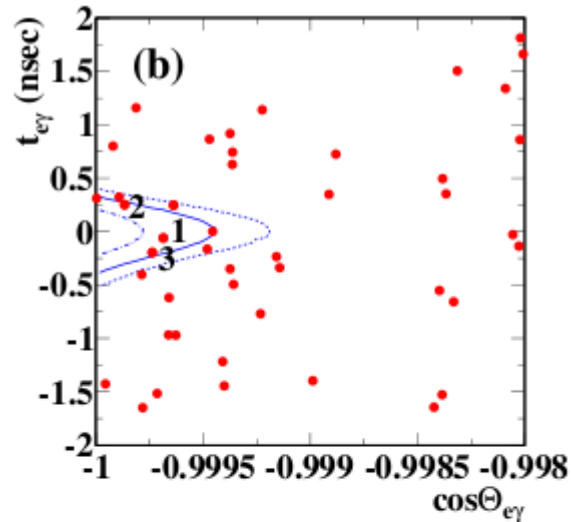
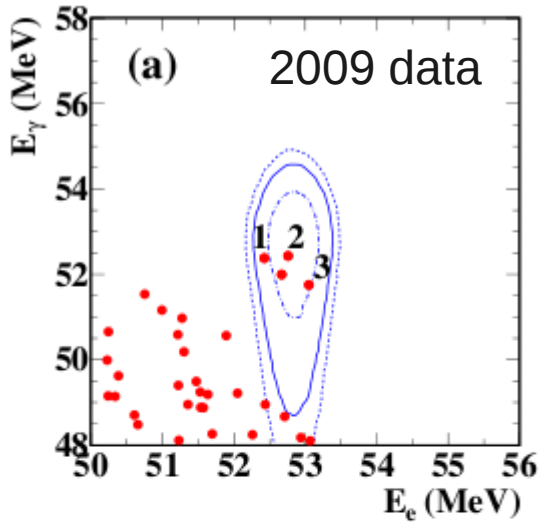

$B(\mu^+ \rightarrow e^+ \gamma) < 2.4 \cdot 10^{-12}$ @ 90% CL
PRL 107 (2011) 171801

Prospects for Lepton Flavour Violation

- MEG still taking data
- New generations of $\mu - e$ conversion experiments
 - COMET at J-PARC, followed by PRISM/PRIME
 - mu2e at FNAL, followed by Project X
 - Potential improvements of $O(10^4) - O(10^6)$ in sensitivities!
- τ LFV a priority for next generation e^+e^- flavour factories
 - SuperKEKB/Belle2 at KEK & SuperB in Italy
 - $O(100)$ improvements in luminosity $\rightarrow O(10) - O(100)$ improvements in sensitivity (depending on background)
 - LHC experiments have some potential to improve $\tau \rightarrow \mu\mu\mu$

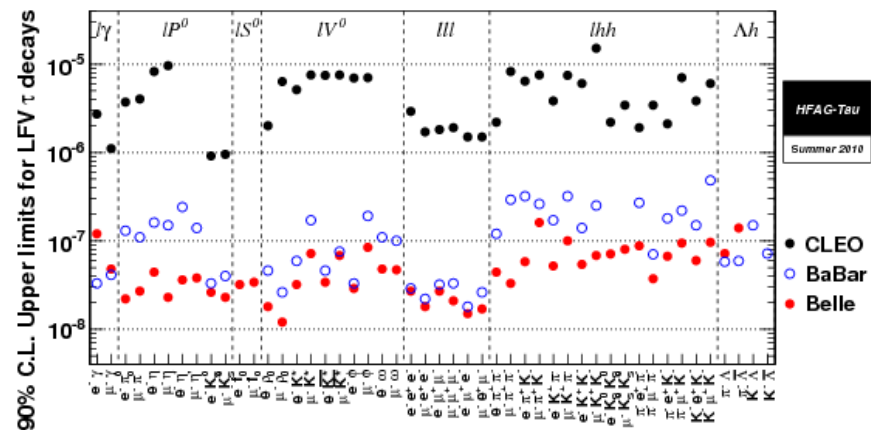

What causes the difference between matter and antimatter?

- The CKM matrix arises from the relative misalignment of the Yukawa matrices for the up- and down-type quarks

$$V_{CKM} = U_u U_d^+$$

U matrices from diagonalisation of mass matrices

- It is a 3x3 complex **unitary** matrix
 - described by 9 (real) parameters
 - 5 can be absorbed as phase differences between the quark fields
 - 3 can be expressed as (Euler) mixing angles
 - the fourth makes the CKM matrix complex (i.e. gives it a phase)
 - weak interaction couplings differ for quarks and antiquarks
 - CP violation

The Cabibbo-Kobayashi-Maskawa Quark Mixing Matrix



$$V_{CKM} = \begin{pmatrix} V_{ud} & V_{us} & V_{ub} \\ V_{cd} & V_{cs} & V_{cb} \\ V_{td} & V_{ts} & V_{tb} \end{pmatrix}$$

- A 3x3 unitary matrix
- Described by 4 real parameters – **allows CP violation**
 - PDG (Chau-Keung) parametrisation: $\theta_{12}, \theta_{23}, \theta_{13}, \delta$
 - Wolfenstein parametrisation: λ, A, ρ, η
- **Highly predictive**

Range of CKM phenomena

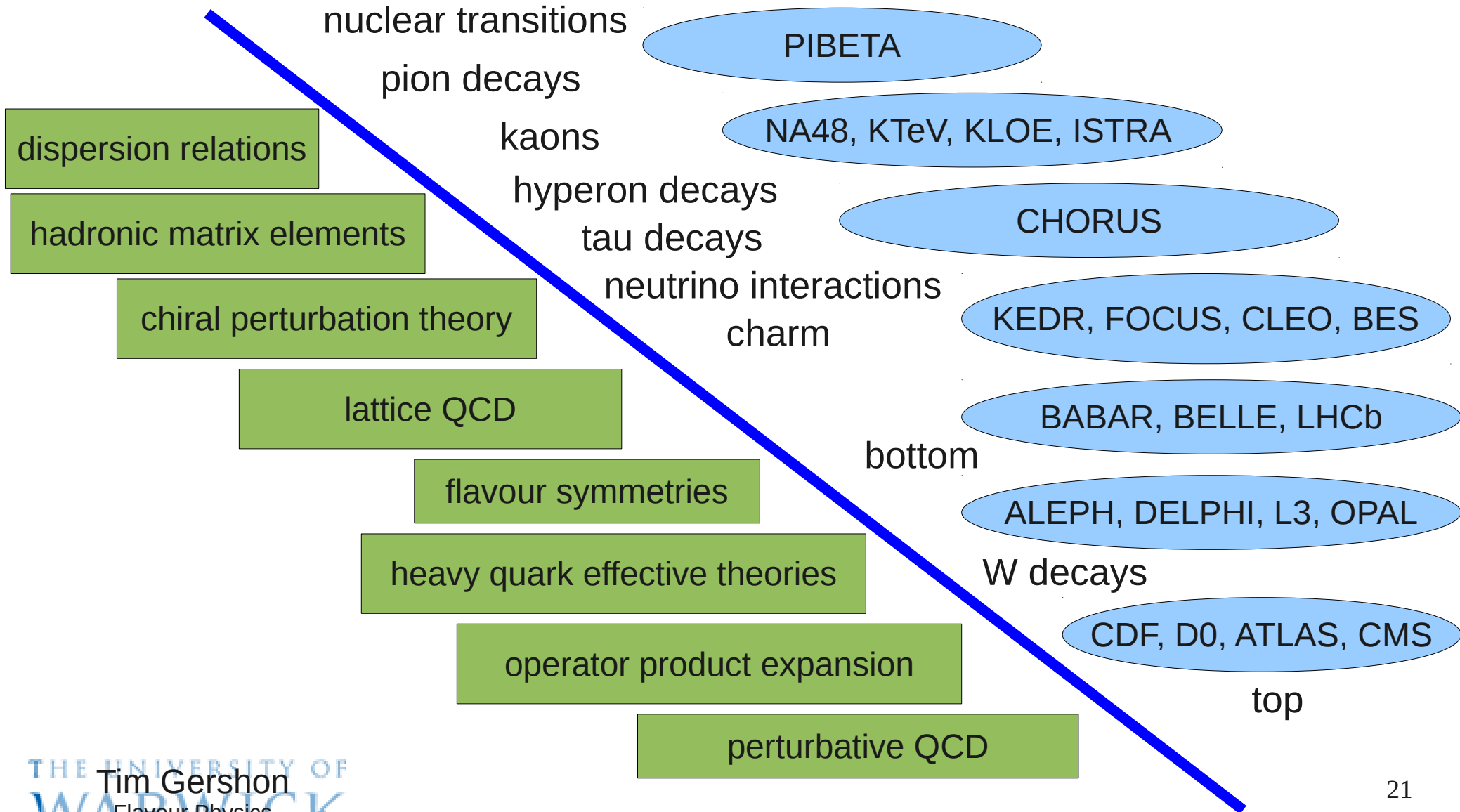

A brief history of CP violation and Nobel Prizes

- 1964 – Discovery of CP violation in K^0 system
PRL 13 (1964) 138
- 1973 – Kobayashi and Maskawa propose 3 generations
Prog.Theor.Phys. 49 (1973) 652
- 1980 – Nobel Prize to Cronin and Fitch

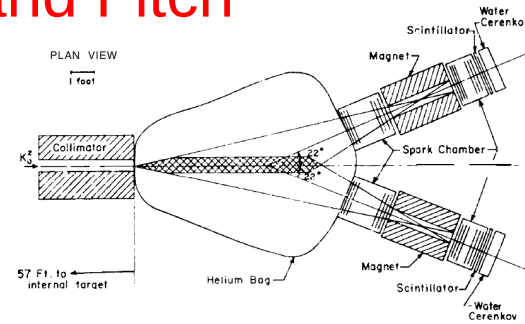

Fig. 1. Plan view of the apparatus as located at the A. G. S.

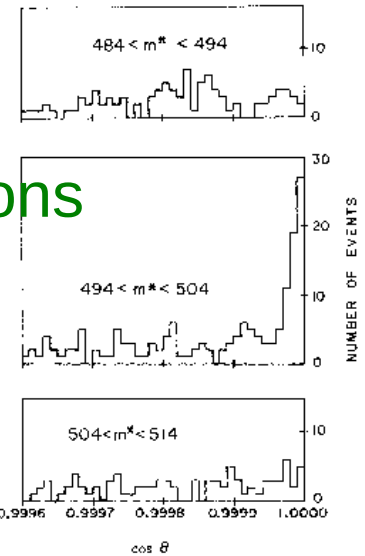
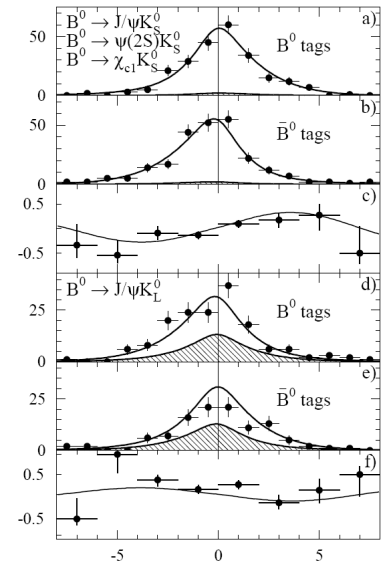
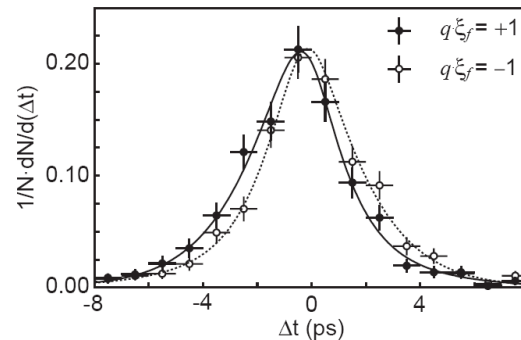
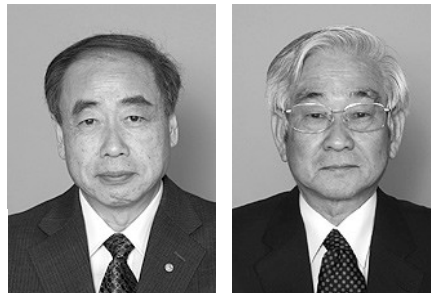

FIG. 3. Angular distribution in three mass ranges for events with $\cos\theta > 0.9995$.

- 2001 – Discovery of CP violation in B_d system
- 2008 – Nobel Prize to Kobayashi and Maskawa



Sakharov conditions

- Proposed by A.Sakharov, 1967
- Necessary for evolution of matter dominated universe, from symmetric initial state
 - (1) baryon number violation
 - (2) C & CP violation
 - (3) thermal inequilibrium
- No significant amounts of antimatter observed
- $\Delta N_B / N_Y = (N(\text{baryon}) - N(\text{antibaryon})) / N_Y \sim 10^{-10}$

We need more CP violation!

- Widely accepted that SM CPV insufficient to explain observed baryon asymmetry of the Universe
- To create a larger asymmetry, require
 - new sources of CP violation
 - that occur at high energy scales
- Where might we find it?
 - lepton sector: CP violation in neutrino oscillations
 - quark sector: discrepancies with KM predictions
 - gauge sector, extra dimensions, other new physics: precision measurements of flavour observables are generically sensitive to additions to the Standard Model

The neutrino sector

- Enticing possibility that neutrinos may be Majorana particles
 - provides connection with high energy scale
 - CP violation in leptons could be transferred to baryon sector (via B-L conserving processes)
- Requires
 - Determination of PMNS matrix
 - All mixing angles and CP phase must be non-zero
 - Experimental proof that neutrinos are Majorana
- Hope for answers to these questions within LHC era

Daya Bay measurement of $\theta_{13} \neq 0$

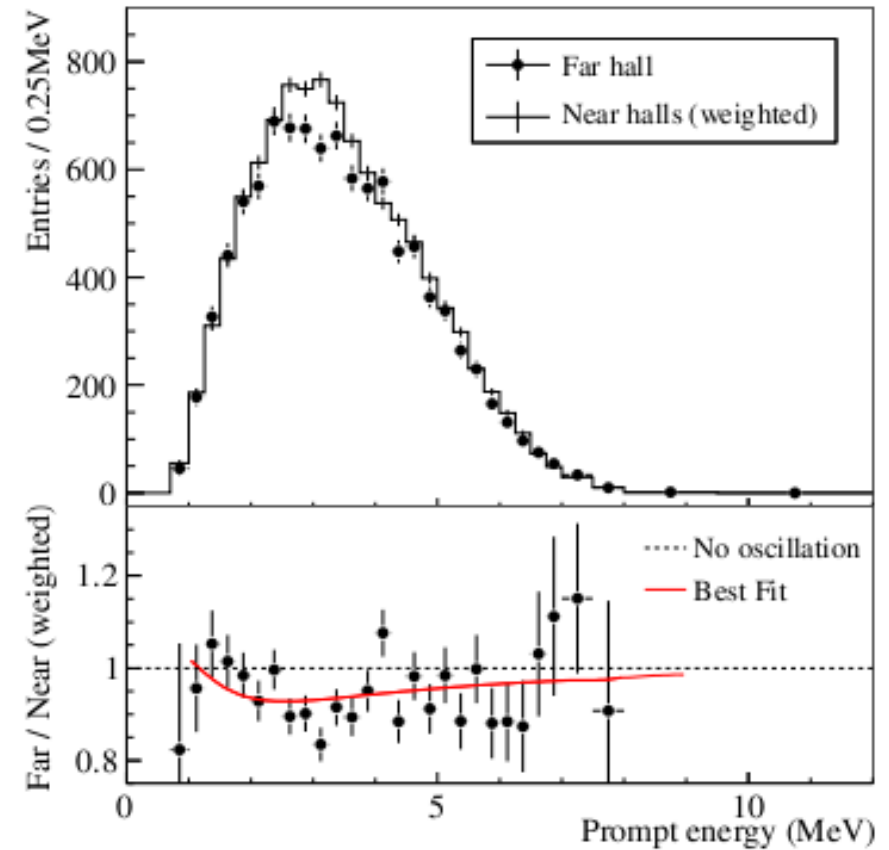
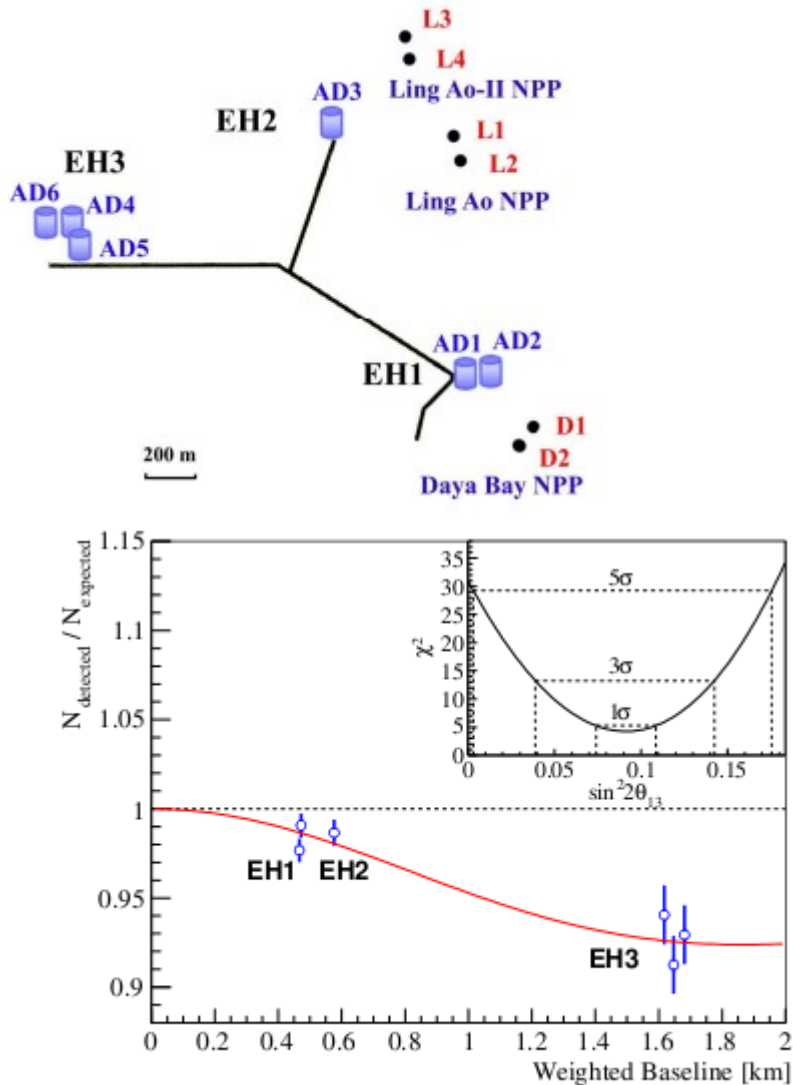

$$\sin^2 2\theta_{13} = 0.092 \pm 0.016 \text{ (stat)} \pm 0.005 \text{ (syst)}$$

PRL 108 (2012) 171803

Flavour for new physics discoveries

A lesson from history

- New physics shows up at precision frontier before energy frontier
 - GIM mechanism before discovery of charm
 - CP violation / CKM before discovery of bottom & top
 - Neutral currents before discovery of Z
- Particularly sensitive – loop processes
 - Standard Model contributions suppressed / absent
 - flavour changing neutral currents (rare decays)
 - CP violation
 - lepton flavour / number violation / lepton universality

Neutral meson oscillations

- We have flavour eigenstates M^0 and \bar{M}^0
 - M^0 can be K^0 ($\bar{s}d$), D^0 ($c\bar{u}$), B_d^0 ($\bar{b}d$) or B_s^0 ($\bar{b}s$)
- These can mix into each other
 - via short-distance or long-distance processes
- Time-dependent Schrödinger eqn.

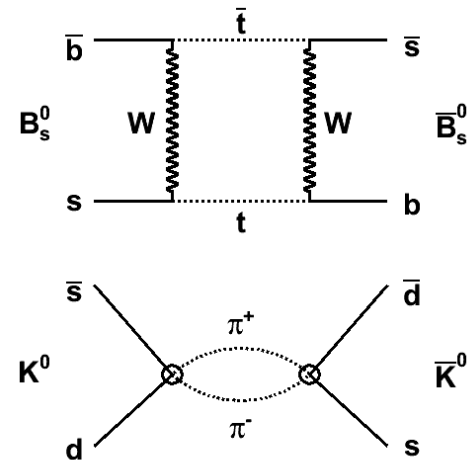

$$i \frac{\partial}{\partial t} \begin{pmatrix} M^0 \\ \bar{M}^0 \end{pmatrix} = H \begin{pmatrix} M^0 \\ \bar{M}^0 \end{pmatrix} = \left(M - \frac{i}{2} \Gamma \right) \begin{pmatrix} M^0 \\ \bar{M}^0 \end{pmatrix}$$

– H is Hamiltonian; M and Γ are 2x2 Hermitian matrices

- CPT theorem: $M_{11} = M_{22}$ & $\Gamma_{11} = \Gamma_{22}$

Solving the Schrödinger equation

- Physical states: eigenstates of effective Hamiltonian

$$M_{S,L} = p M^0 \pm q \bar{M}^0$$

p & q complex coefficients
that satisfy $|p|^2 + |q|^2 = 1$

label as either S,L (short-, long-lived) or L,H (light, heavy) depending on values of Δm & $\Delta\Gamma$ (labels 1,2 usually reserved for CP eigenstates)

- CP conserved if physical states = CP eigenstates ($|q/p| = 1$)

- Eigenvalues

$$\lambda_{S,L} = m_{S,L} - \frac{1}{2}i\Gamma_{S,L} = (M_{11} - \frac{1}{2}i\Gamma_{11}) \pm (q/p)(M_{12} - \frac{1}{2}i\Gamma_{12})$$

$$\Delta m = m_L - m_S \quad \Delta\Gamma = \Gamma_S - \Gamma_L$$

$$(\Delta m)^2 - \frac{1}{4}(\Delta\Gamma)^2 = 4(|M_{12}|^2 + \frac{1}{4}|\Gamma_{12}|^2)$$

$$\Delta m \Delta\Gamma = 4\text{Re}(M_{12} \Gamma_{12}^*)$$

$$(q/p)^2 = (M_{12}^* - \frac{1}{2}i\Gamma_{12}^*) / (M_{12} - \frac{1}{2}i\Gamma_{12})$$

Simplistic picture of mixing parameters

- Δm : value depends on rate of mixing diagram

- together with various other constants ...

$$\Delta m_d = \frac{G_F^2}{6\pi^2} m_W^2 \eta_b S(x_t) m_{B_d} f_{B_d}^2 \hat{B}_{B_d} |V_{tb}|^2 |V_{td}|^2$$

- that can be made to cancel in ratios

remaining factors can be obtained from lattice QCD calculations

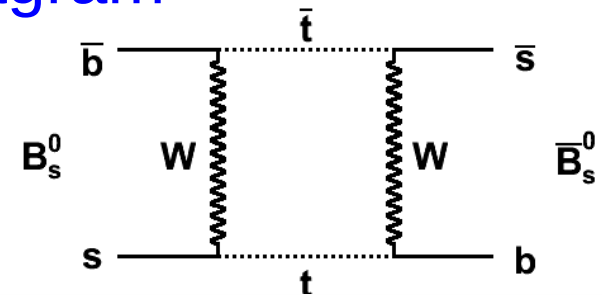

$$\frac{\Delta m_d}{\Delta m_s} = \frac{m_{B_d} f_{B_d}^2 \hat{B}_{B_d} |V_{td}|^2}{m_{B_s} f_{B_s}^2 \hat{B}_{B_s} |V_{ts}|^2}$$

- $\Delta\Gamma$: value depends on widths of decays into common final states (CP-eigenstates)

- large for K^0 , small for D^0 & B_d^0

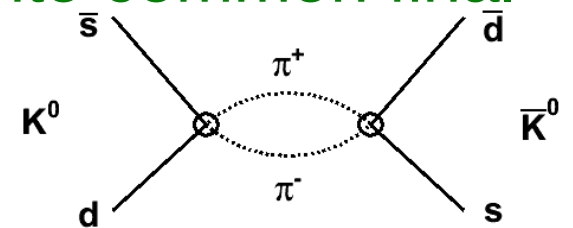

- $q/p \approx 1$ if $\arg(\Gamma_{12}/M_{12}) \approx 0$ ($|q/p| \approx 1$ if $M_{12} \ll \Gamma_{12}$ or $M_{12} \gg \Gamma_{12}$)

- CP violation in mixing when $|q/p| \neq 1$

$$\left(\epsilon = \frac{p-q}{p+q} \neq 0 \right)$$

Simplistic picture of mixing parameters

	Δm ($x = \Delta m/\Gamma$)	$\Delta\Gamma$ ($y = \Delta\Gamma/2\Gamma$)	q/p ($\varepsilon = (p-q)/(p+q)$)
K^0	large ~ 500	\sim maximal ~ 1	small 2×10^{-3}
D^0	small $(0.63 \pm 0.20)\%$	small $(0.75 \pm 0.12)\%$	small 0.06 ± 0.09
B^0	medium 0.770 ± 0.008	small 0.008 ± 0.009	small -0.0008 ± 0.0008
B_s^0	large 26.49 ± 0.29	medium 0.075 ± 0.010	small -0.0026 ± 0.0016

Simplistic picture of mixing parameters

	Δm ($x = \Delta m/\Gamma$)	$\Delta\Gamma$ ($y = \Delta\Gamma/2\Gamma$)	q/p ($\varepsilon = (p-q)/(p+q)$)
K^0	large ~ 500	\sim maximal ~ 1	small 2×10^{-3}
D^0	small $(0.63 \pm 0.20)\%$	small $(0.75 \pm 0.12)\%$	small 0.06 ± 0.09
B^0	medium 0.770 ± 0.008	small 0.008 ± 0.009	small -0.0008 ± 0.0008
B_s^0	large 26.49 ± 0.29	medium 0.075 ± 0.010	small -0.0026 ± 0.0016

well-measured only
recently (see later)

More precise
measurements needed
(SM prediction well known)

Like-sign dimuon asymmetry

- Semileptonic decays are flavour-specific
- B mesons are produced in $B\bar{B}$ pairs
- Like-sign leptons arise if one of $B\bar{B}$ pair mixes before decaying
- If no CP violation in mixing $N(++)=N(--)$
- Inclusive measurement \leftrightarrow contributions from both B_d^0 and B_s^0
 - relative contributions from production rates, mixing probabilities & SL decay rates

PRD 84 (2011) 052007

$$A_{SL} = (1 - |q/p|^4)/(1 + |q/p|^4)$$

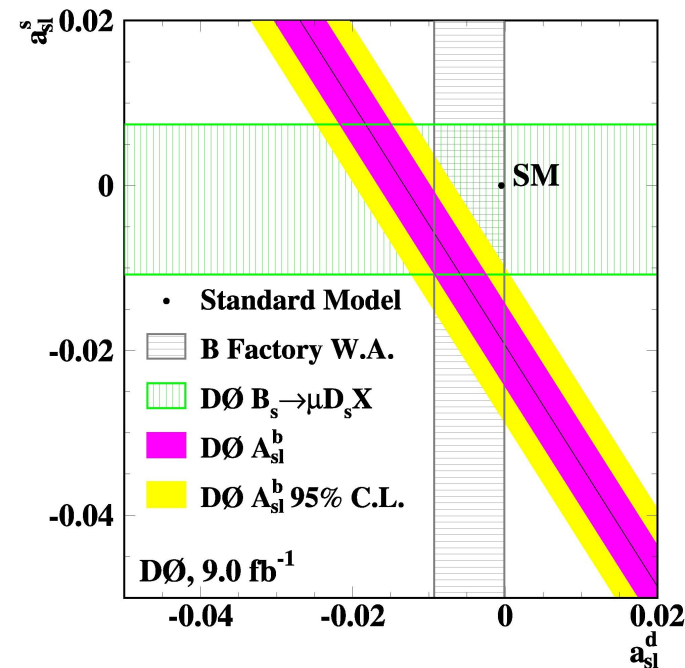

What do we know about heavy quark flavour physics as of today?

CKM Matrix : parametrizations

- Many different possible choices of 4 parameters
- PDG: 3 mixing angles and 1 phase

PRL 53 (1984) 1802

$$V = \begin{pmatrix} V_{ud} & V_{us} & V_{ub} \\ V_{cd} & V_{cs} & V_{cb} \\ V_{td} & V_{ts} & V_{tb} \end{pmatrix} = \begin{pmatrix} c_{12}c_{13} & s_{12}c_{13} & s_{13}e^{-i\delta} \\ -s_{12}c_{23} - c_{12}s_{23}s_{13}e^{i\delta} & c_{12}c_{23} - s_{12}s_{23}s_{13}e^{i\delta} & s_{23}c_{13} \\ s_{12}s_{23} - c_{12}c_{23}s_{13}e^{i\delta} & -c_{12}s_{23} - s_{12}c_{23}s_{13}e^{i\delta} & c_{23}c_{13} \end{pmatrix}$$

- Apparent hierarchy: $s_{12} \sim 0.2$, $s_{23} \sim 0.04$, $s_{13} \sim 0.004$

– [Wolfenstein parametrization](#) (expansion parameter $\lambda \sim \sin \theta_c \sim 0.22$)

PRL 51 (1983) 1945

$$V = \begin{pmatrix} 1 - \frac{1}{2}\lambda^2 & \lambda & A\lambda^3(\rho - i\eta) \\ -\lambda & 1 - \frac{1}{2}\lambda^2 & A\lambda^2 \\ A\lambda^3(1 - \rho - i\eta) & -A\lambda^2 & 1 \end{pmatrix} + \mathcal{O}(\lambda^4)$$

- Other choices, eg. based on CP violating phases

Hierarchy in quark mixing

$$V = \begin{pmatrix} 1 - \frac{1}{2}\lambda^2 & \lambda & A\lambda^3(\rho - i\eta) \\ -\lambda & 1 - \frac{1}{2}\lambda^2 & A\lambda^2 \\ A\lambda^3(1 - \rho - i\eta) & -A\lambda^2 & 1 \end{pmatrix} + \mathcal{O}(\lambda^4)$$

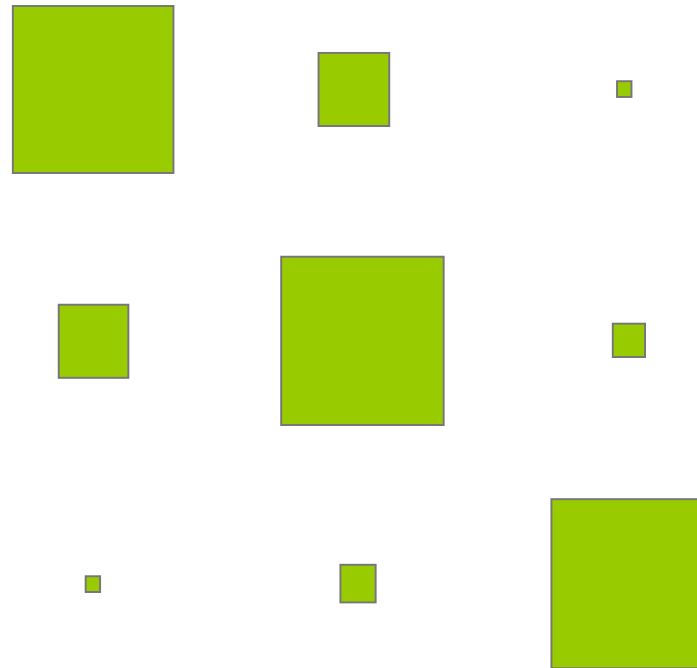

Very suggestive pattern
 No known underlying reason
 Situation for leptons (vs) is completely different

CKM matrix to $O(\lambda^5)$

$$V_{\text{CKM}} = \begin{pmatrix} 1 - \frac{1}{2}\lambda^2 - \frac{1}{8}\lambda^4 & \lambda & A\lambda^3(\rho - i\eta) \\ -\lambda + \frac{1}{2}A^2\lambda^5[1 - 2(\rho + i\eta)] & 1 - \frac{1}{2}\lambda^2 - \frac{1}{8}\lambda^4(1 + 4A^2) & A\lambda^2 \\ A\lambda^3[1 - (1 - \frac{1}{2}\lambda^2)(\rho + i\eta)] & -A\lambda^2 + \frac{1}{2}A\lambda^4[1 - 2(\rho + i\eta)] & 1 - \frac{1}{2}A^2\lambda^4 \end{pmatrix}$$

Diagram illustrating the CKM matrix elements and their imaginary parts:

- Red oval: $-\lambda + \frac{1}{2}A^2\lambda^5[1 - 2(\rho + i\eta)]$ (imaginary part at $O(\lambda^5)$)
- Blue oval: $A\lambda^3(\rho - i\eta)$ (imaginary part at $O(\lambda^3)$)
- Green oval: $-A\lambda^2 + \frac{1}{2}A\lambda^4[1 - 2(\rho + i\eta)]$ (imaginary part at $O(\lambda^4)$)
- Blue oval: $A\lambda^2$ (imaginary part at $O(\lambda^3)$)

Remember – only *relative* phases are observable

Unitarity Tests

- The CKM matrix must be unitary

$$V_{CKM}^+ V_{CKM} = V_{CKM} V_{CKM}^+ = 1$$

- Provides numerous tests of constraints between independent observables, such as

$$\begin{aligned} |V_{ud}|^2 + |V_{us}|^2 + |V_{ub}|^2 &= 1 \\ V_{ud} V_{ub}^* + V_{cd} V_{cb}^* + V_{td} V_{tb}^* &= 0 \end{aligned}$$

CKM Matrix – Magnitudes

PDG 2010

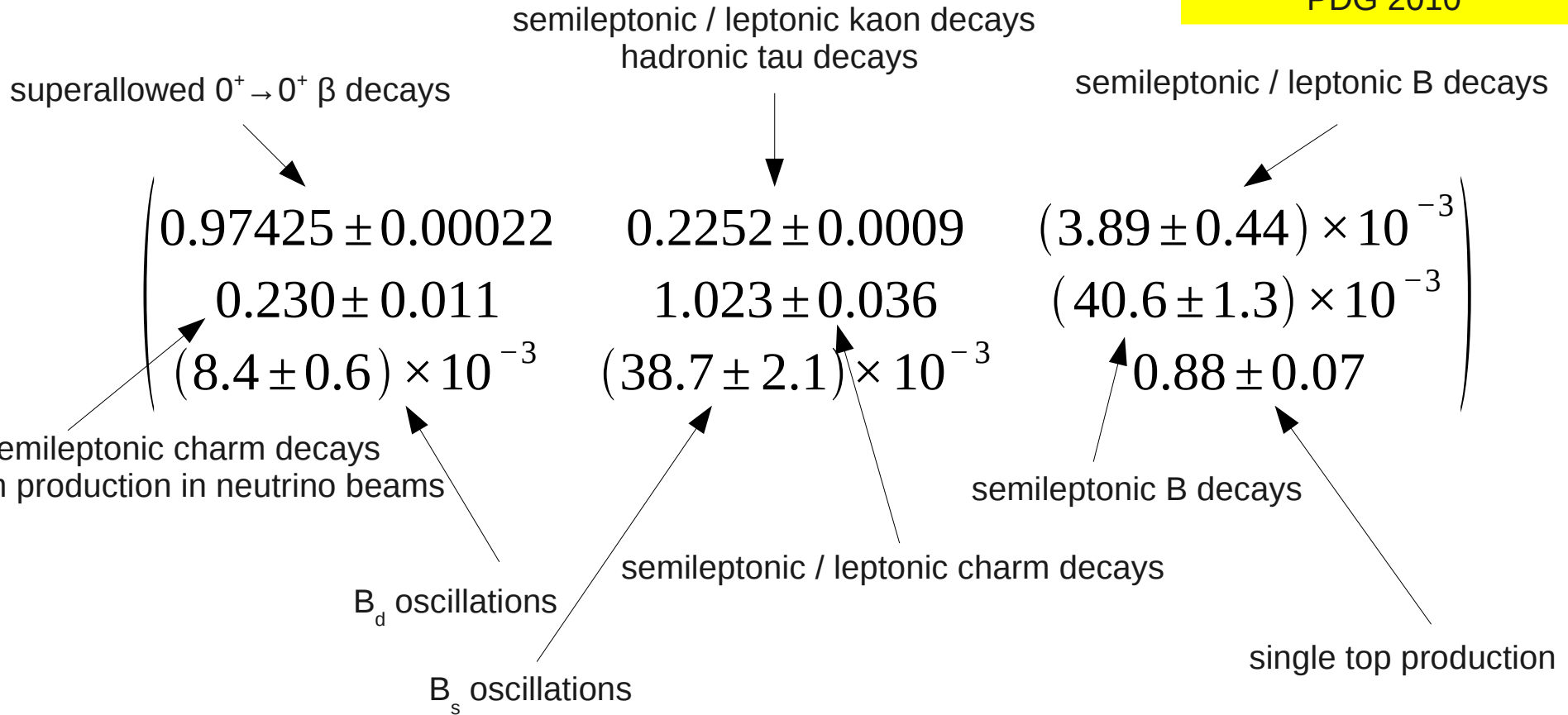

theory inputs (eg., lattice calculations) required

The Unitarity Triangle

$$V_{ud} V_{ub}^* + V_{cd} V_{cb}^* + V_{td} V_{tb}^* = 0$$



Three complex numbers add to zero
 \Rightarrow triangle in Argand plane

Axes are $\bar{\rho}$ and $\bar{\eta}$ where

$$\bar{\rho} + i\bar{\eta} \equiv -\frac{V_{ud}V_{ub}^*}{V_{cd}V_{cb}^*}$$

$$\rho + i\eta = \frac{\sqrt{1 - A^2\lambda^4}(\bar{\rho} + i\bar{\eta})}{\sqrt{1 - \lambda^2} [1 - A^2\lambda^4(\bar{\rho} + i\bar{\eta})]}$$

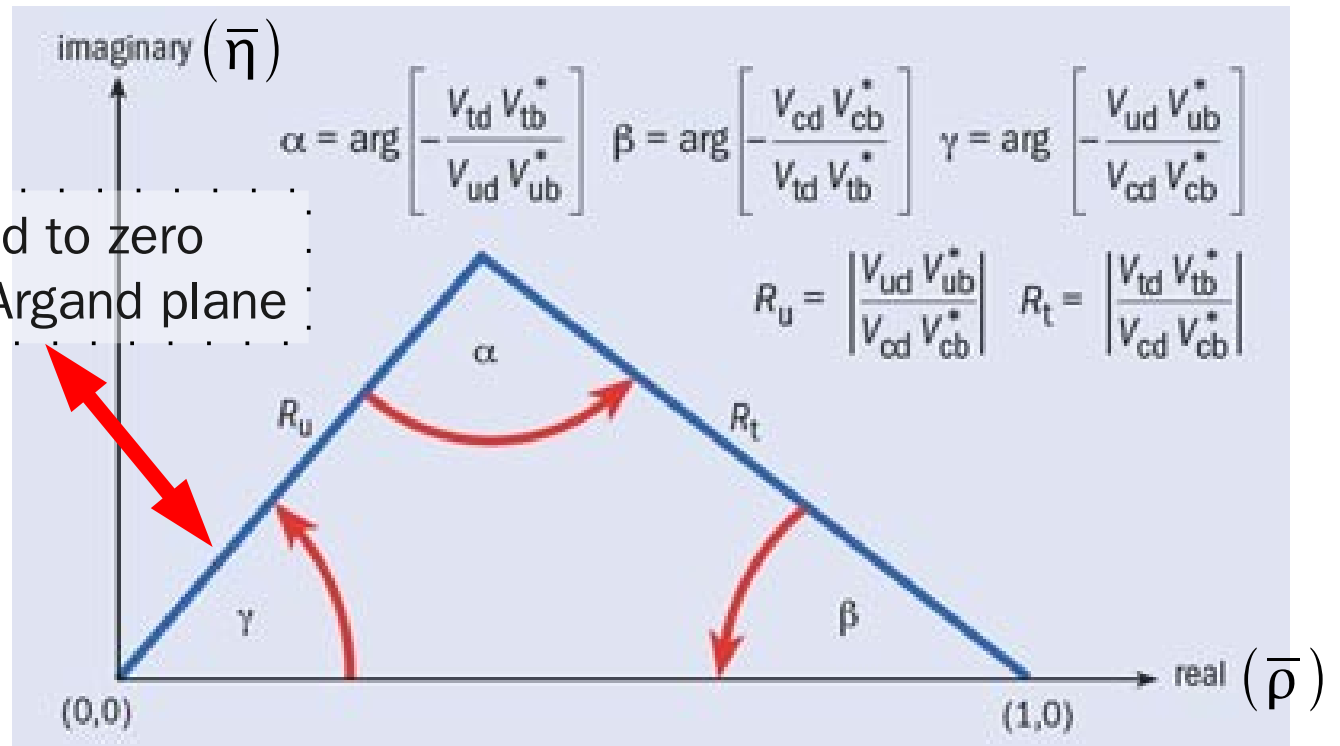

Still to come in today's lecture

β, α, R_t, R_u

Predictive nature of KM mechanism

In the Standard Model the KM phase is the **sole origin of CP violation**

Hence:

all measurements must agree on the position of the apex of the Unitarity Triangle

(Illustration shown assumes no experimental or theoretical uncertainties)

EPJC 41 (2005) 1

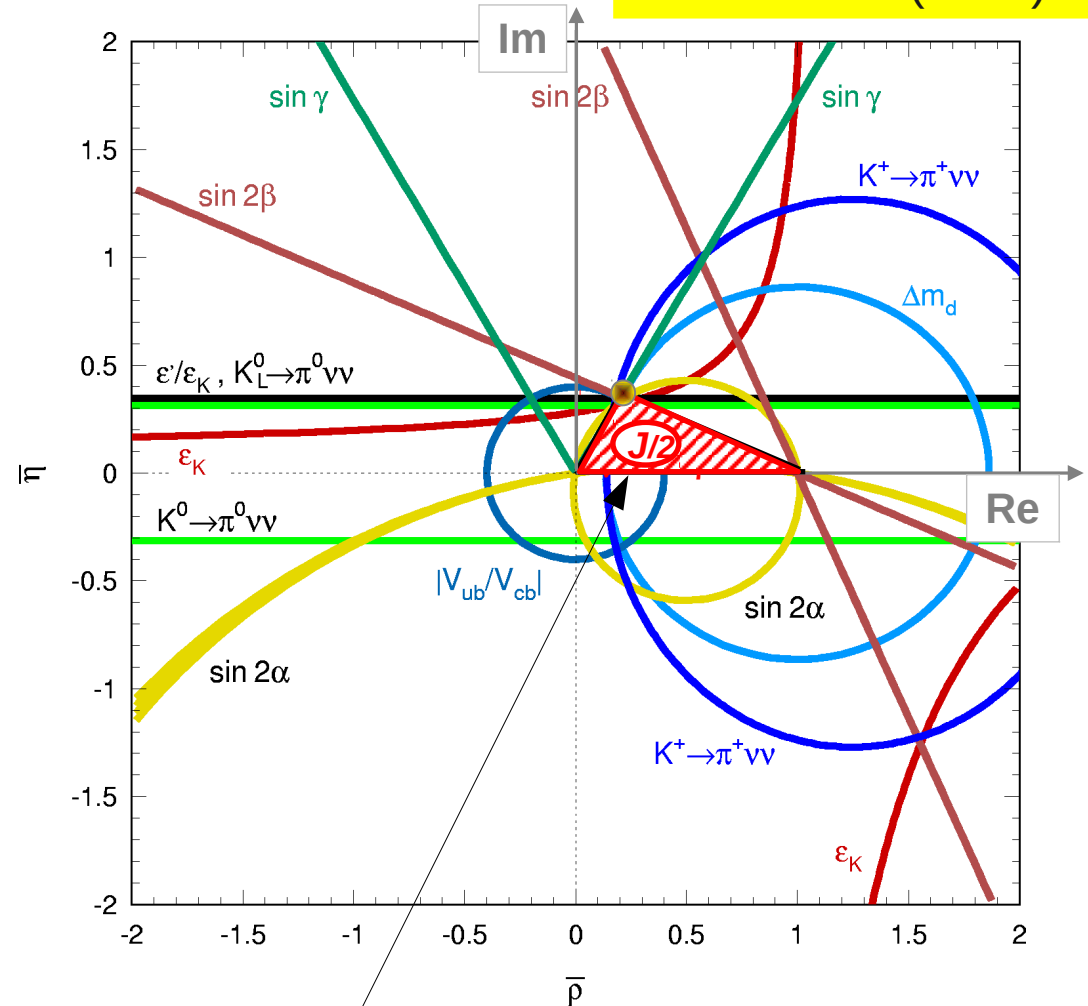

Area of (all of) the Unitarity Triangle(s) is given by the Jarlskog invariant

Time-Dependent CP Violation in the $B^0-\bar{B}^0$ System

- For a B meson known to be 1) B^0 or 2) \bar{B}^0 at time $t=0$, then at later time t :

$$\Gamma(B_{phys}^0 \rightarrow f_{CP}(t)) \propto e^{-\Gamma t} (1 - (S \sin(\Delta m t) - C \cos(\Delta m t)))$$

$$\Gamma(\bar{B}_{phys}^0 \rightarrow f_{CP}(t)) \propto e^{-\Gamma t} (1 + (S \sin(\Delta m t) - C \cos(\Delta m t)))$$

here assume $\Delta\Gamma$ negligible – will see full expressions tomorrow

$$S = \frac{2\Im(\lambda_{CP})}{1 + |\lambda_{CP}^2|} \quad C = \frac{1 - |\lambda_{CP}^2|}{1 + |\lambda_{CP}^2|} \quad \lambda_{CP} = \frac{q}{p} \frac{\bar{A}}{A}$$

For $B^0 \rightarrow J/\psi K_S$, $S = \sin(2\beta)$, $C=0$

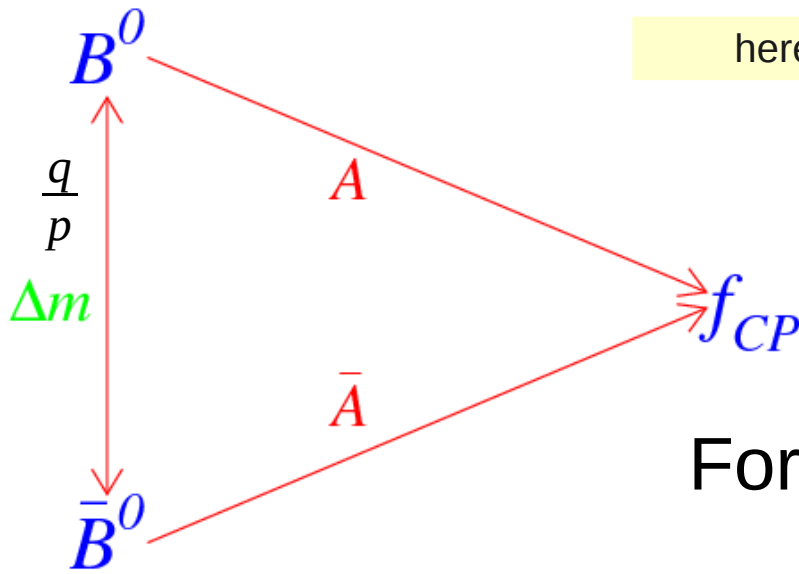

NPB 193 (1981) 85

Categories of CP violation

- Consider decay of neutral particle to a CP eigenstate

$$\lambda_{CP} = \frac{q}{p} \frac{\bar{A}}{A}$$

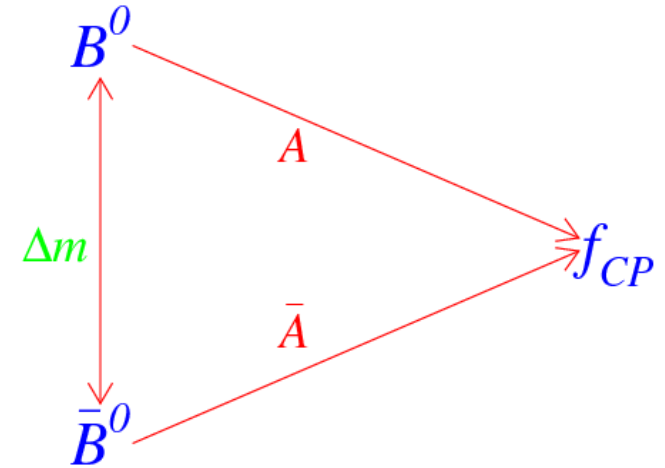

$$\left| \frac{q}{p} \right| \neq 1$$

CP violation in mixing

$$\left| \frac{\bar{A}}{A} \right| \neq 1$$

CP violation in decay (direct CPV)

$$\Im \left(\frac{q}{p} \frac{\bar{A}}{A} \right) \neq 0$$

CP violation in interference between mixing and decay

Asymmetric B factory principle

To measure t require B meson to be moving

→ e^+e^- at threshold with asymmetric collisions (Odone)

Other possibilities considered

→ fixed target production?

→ hadron collider?

→ e^+e^- at high energy?

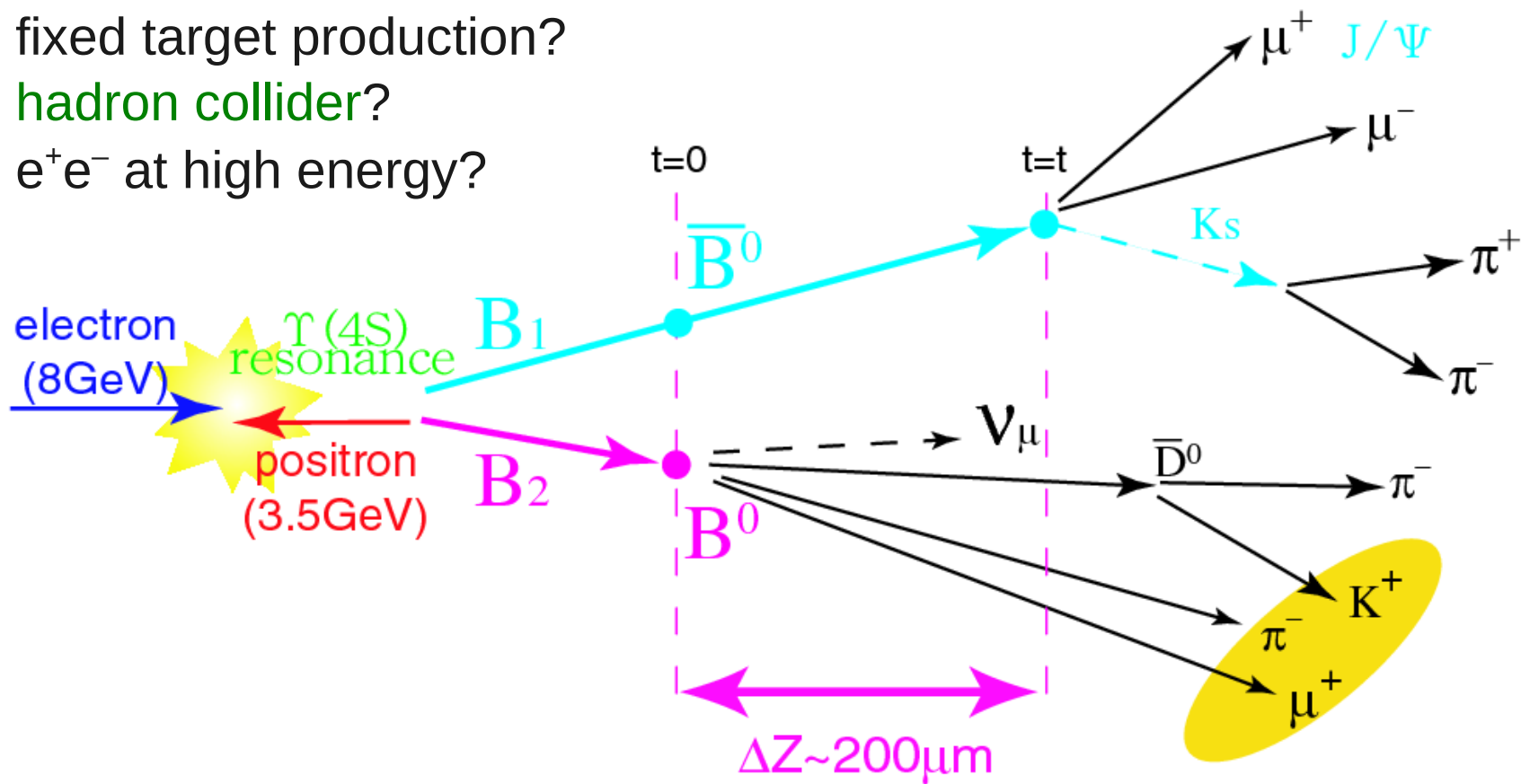

Asymmetric B Factories

PEP-II at SLAC

9.0 GeV e^- on 3.1 GeV e^+

KEKB at KEK

8.0 GeV e^- on 3.5 GeV e^+

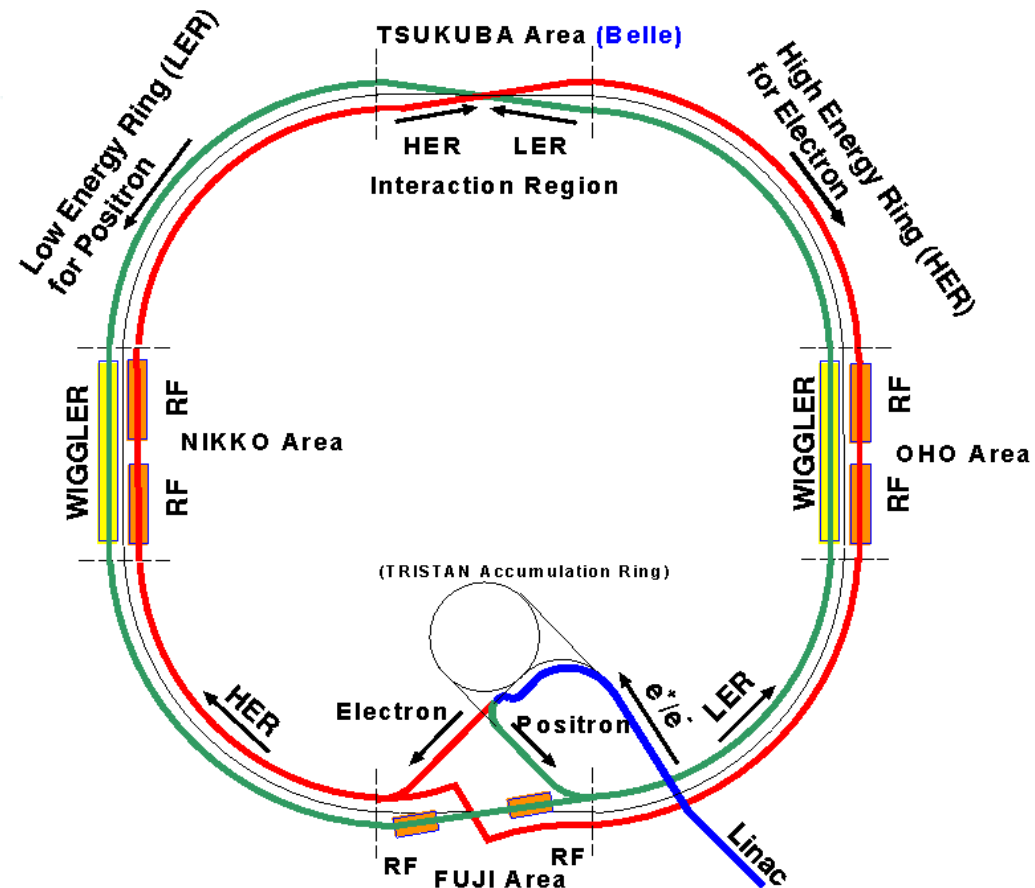
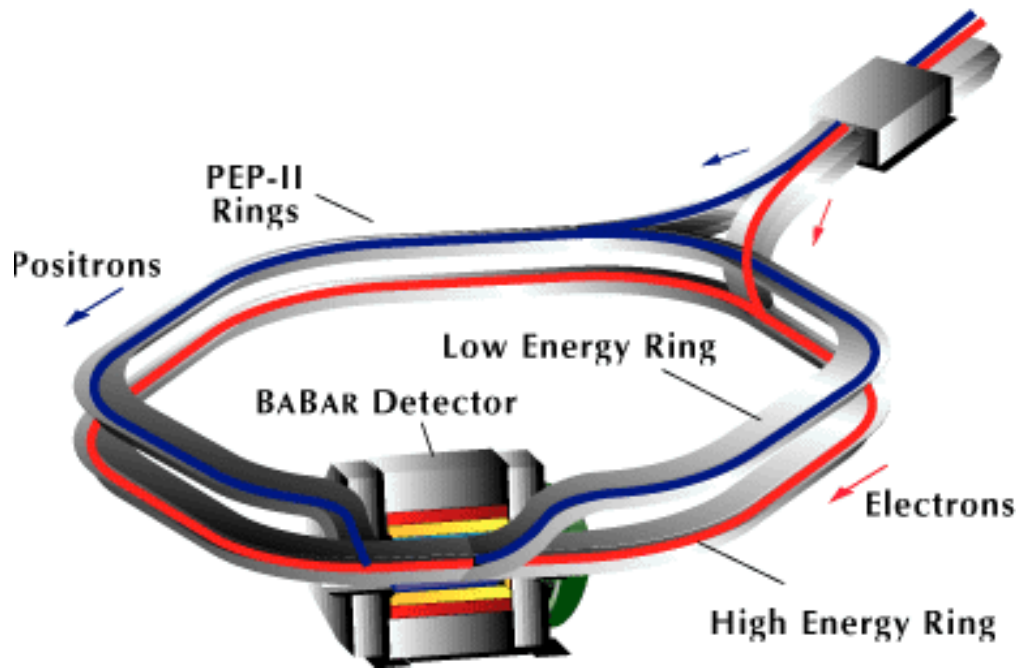

B factories – world record luminosities

As of 2008/04/09 00:00

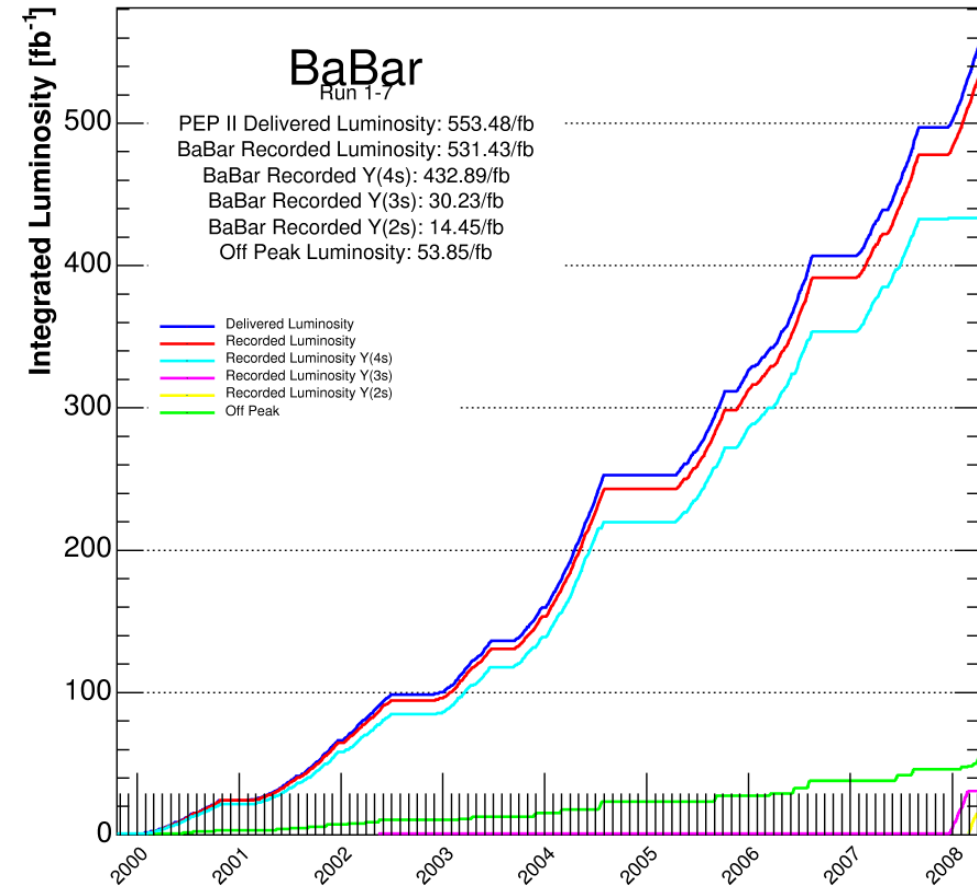

~ 433/fb on Y(4S)

Offline+Online Luminosity (pb^{-1}) (/day)

2008/12/23 14:01

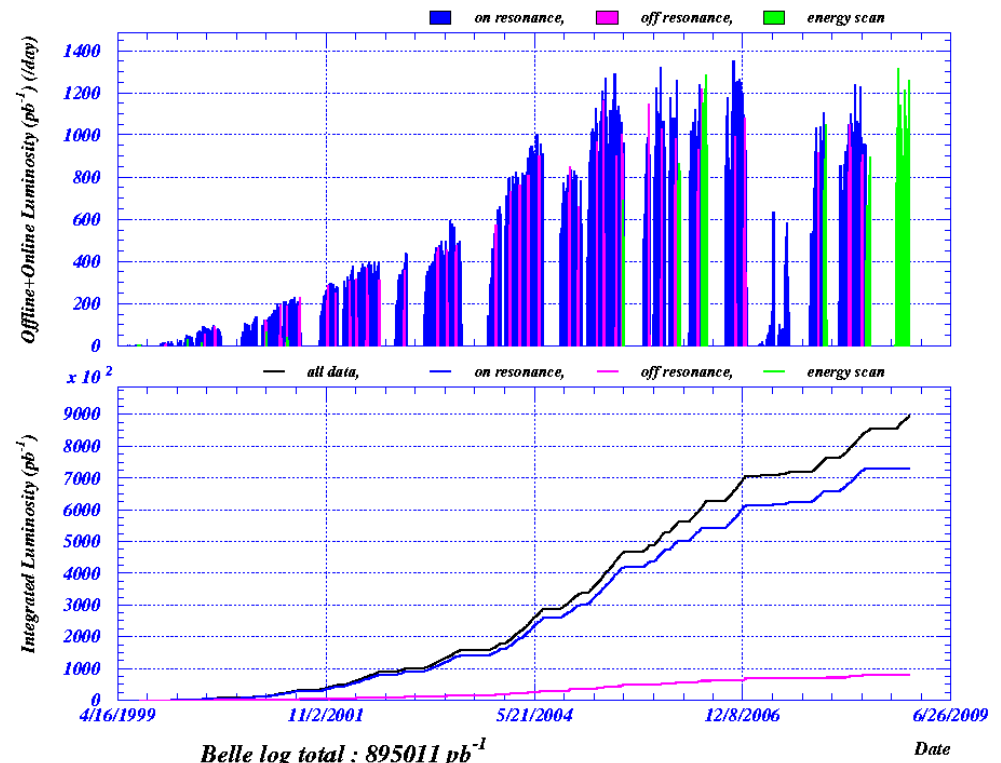

~ 711/fb on Y(4S)

World record luminosities (2)

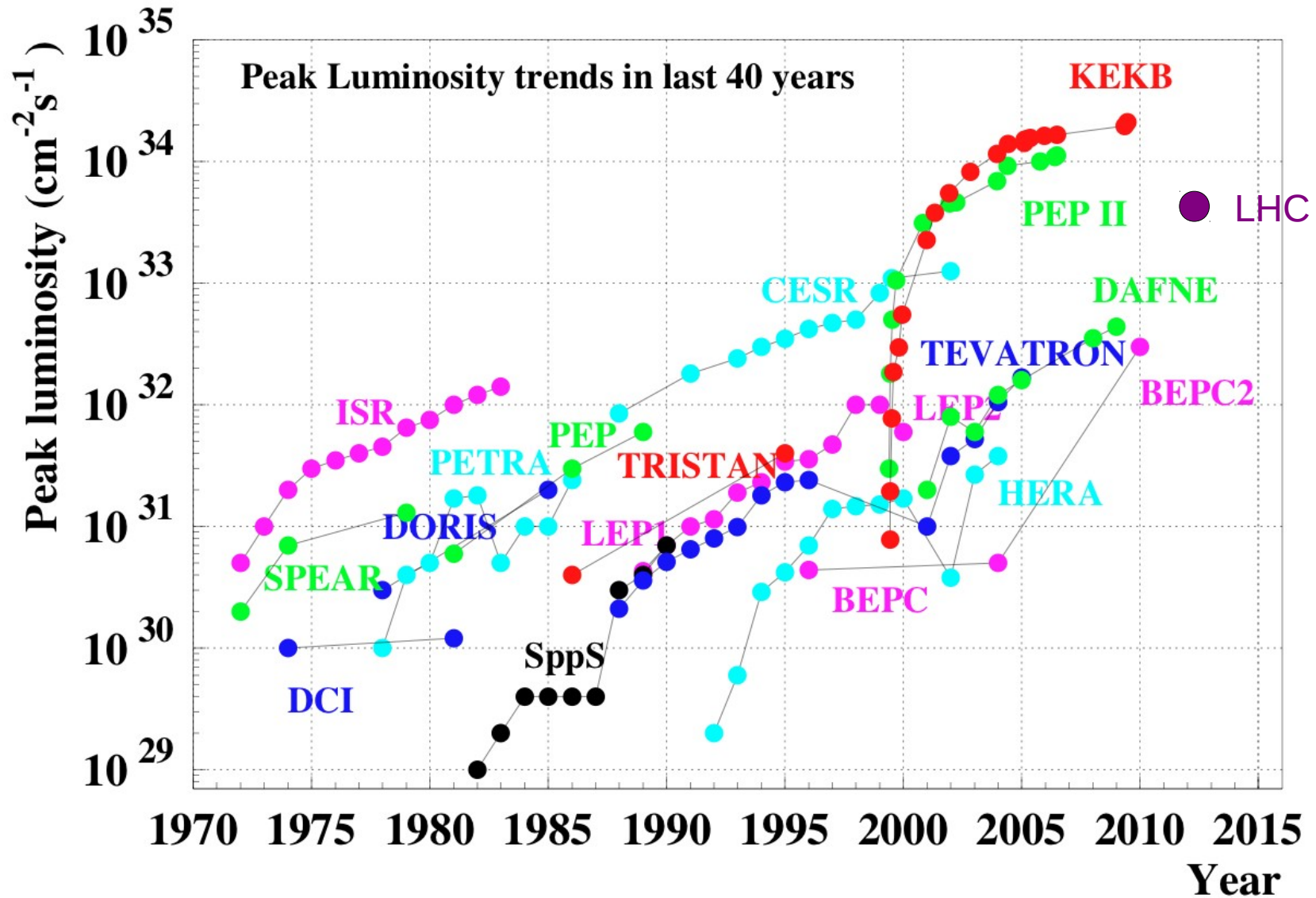

BaBar Detector

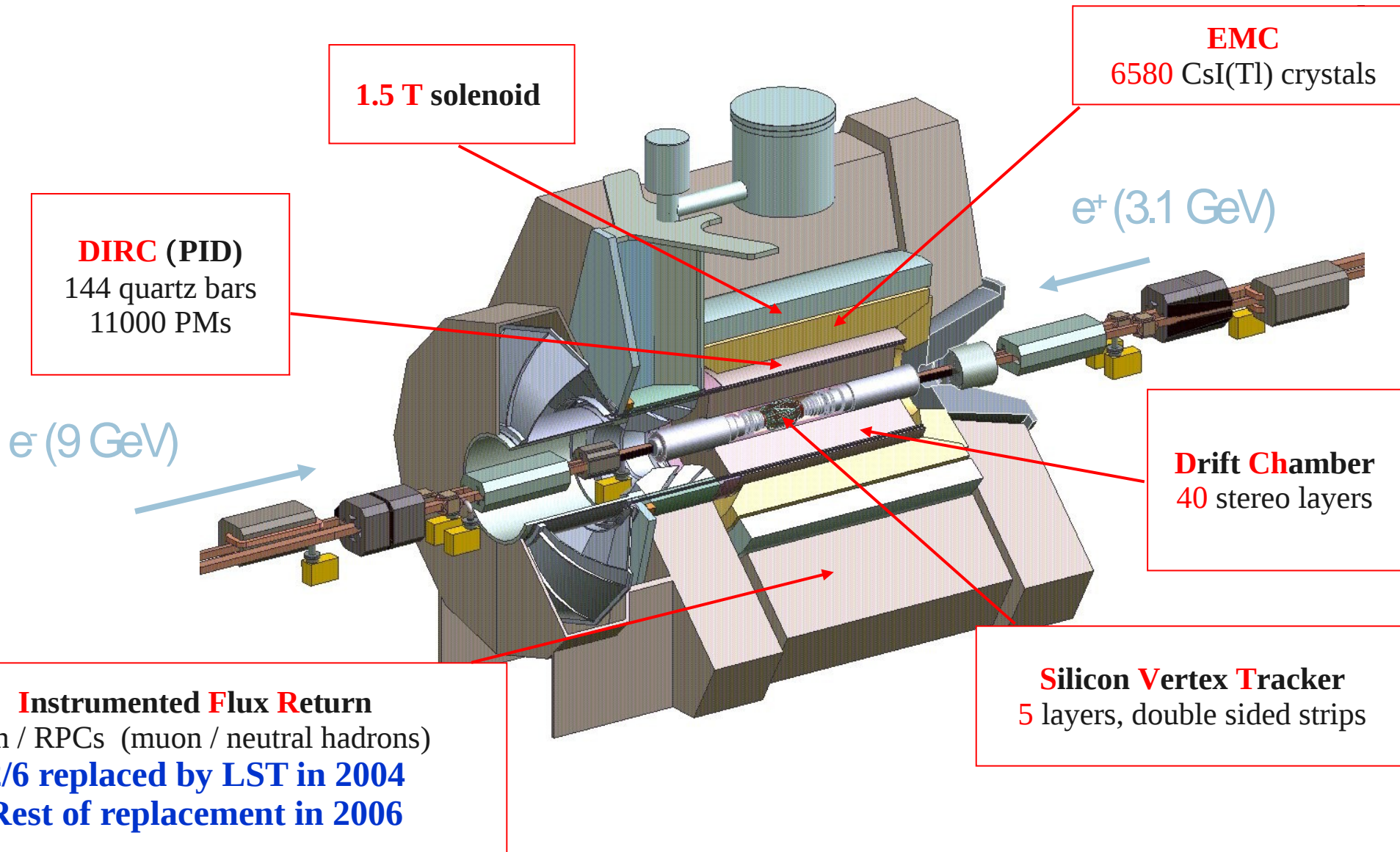

Belle Detector

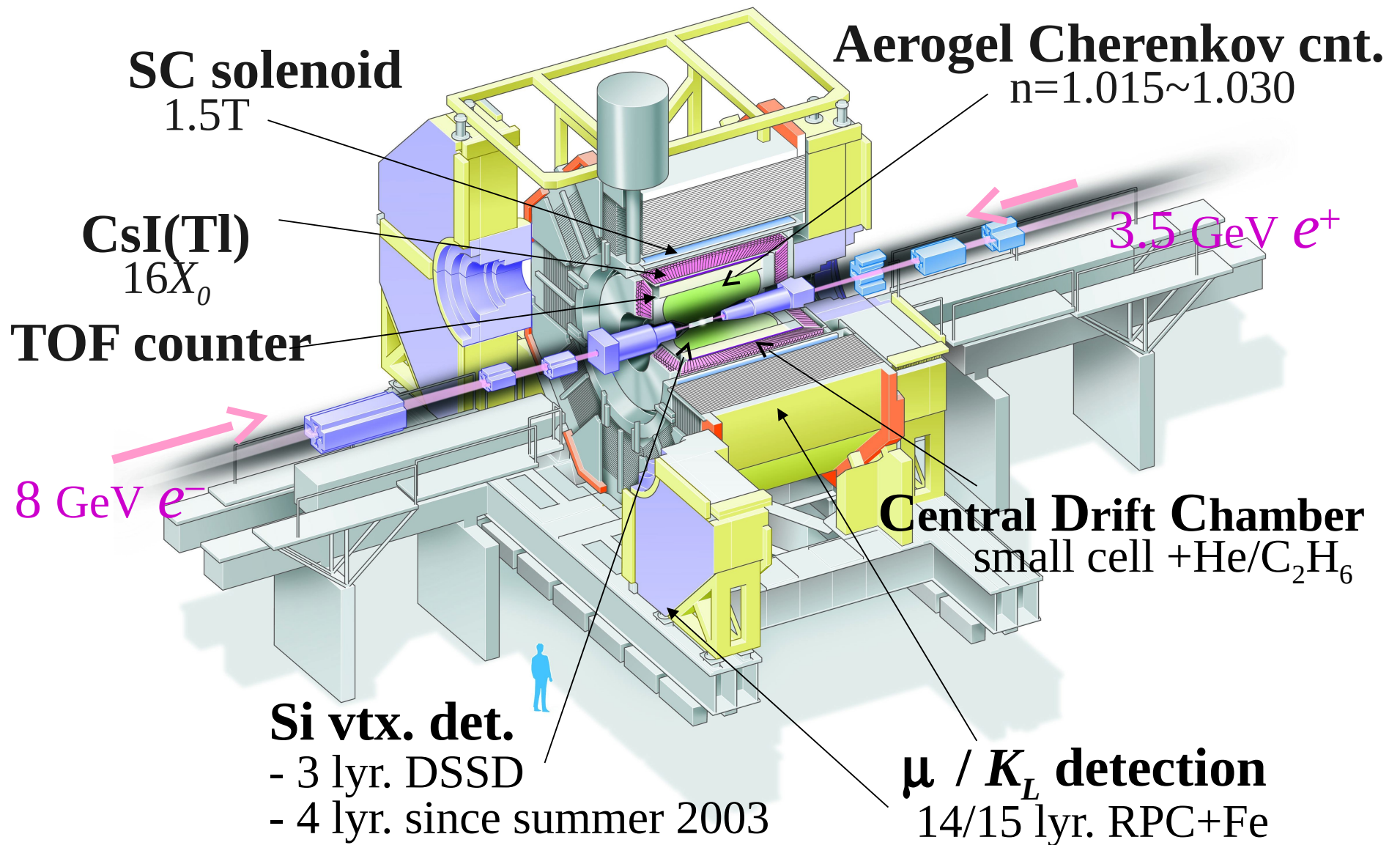

Results for the golden mode



BABAR

BELLE

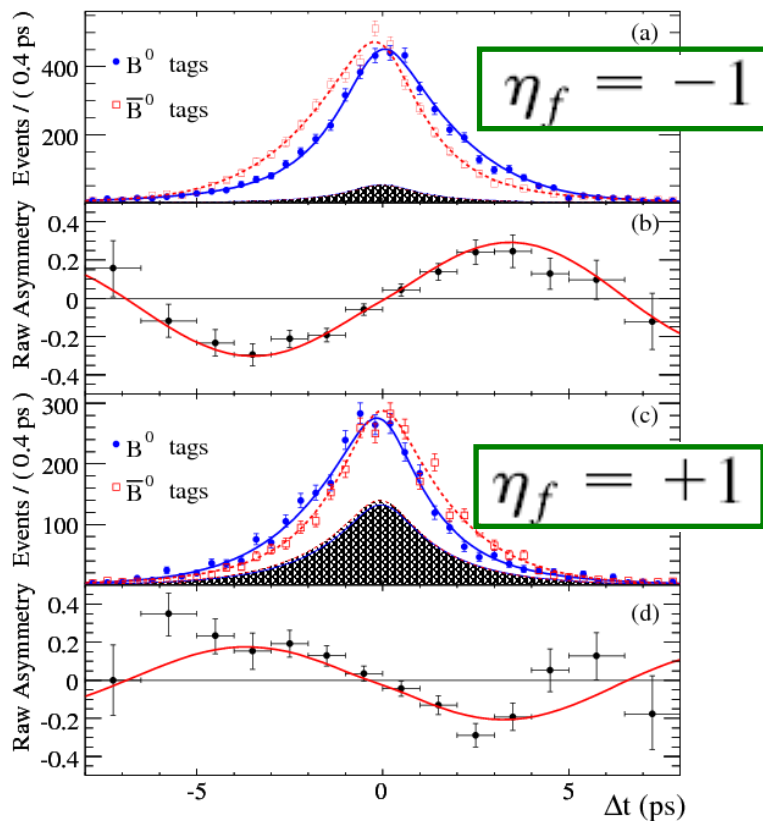

PRD 79 (2009) 072009

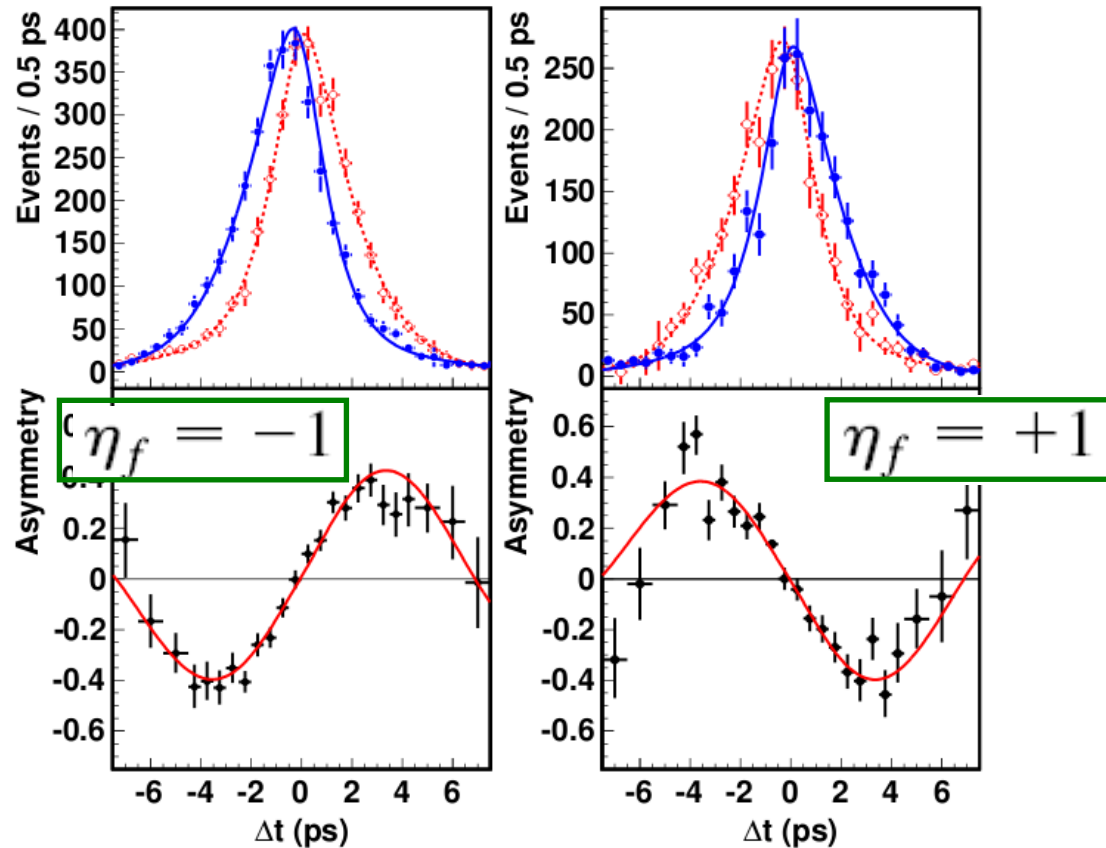

PRL 108 (2012) 171802

Compilation of results

$$\sin(2\beta) \equiv \sin(2\phi_1)$$

HFAG
Moriond 2012
PRELIMINARY

Everything
is here

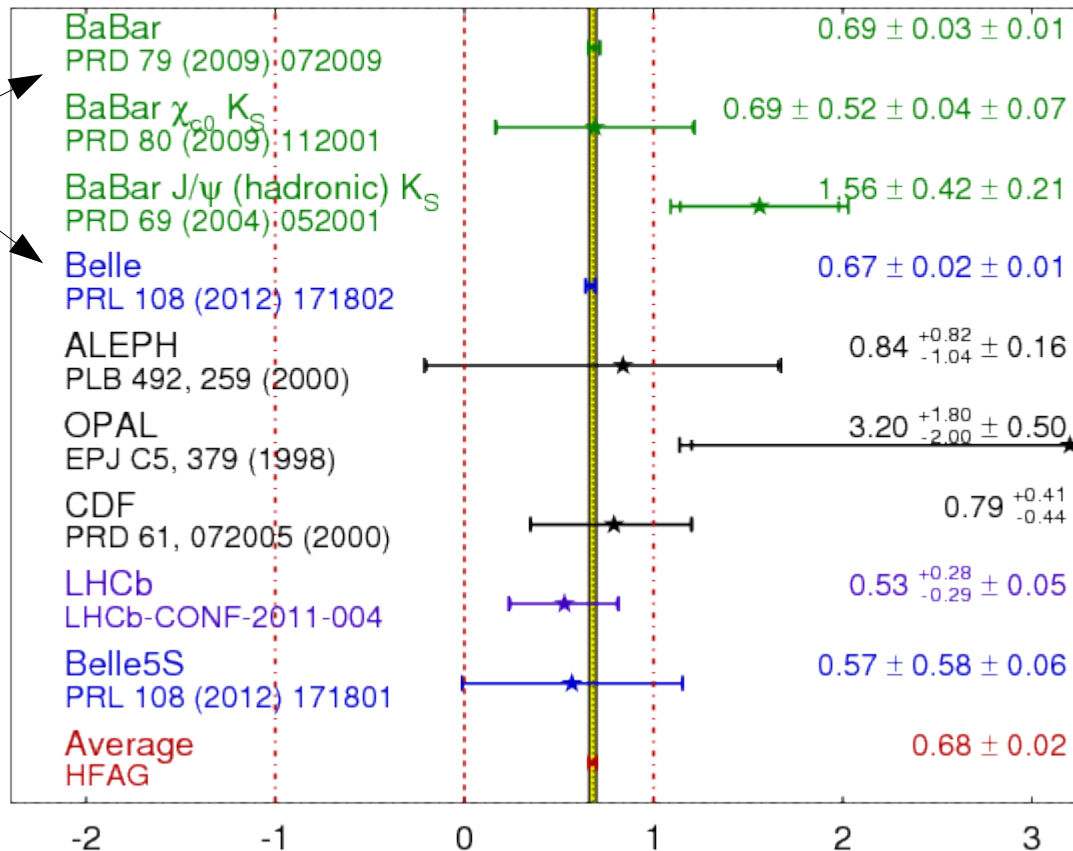

Compilation of results

$$\sin(2\beta) \equiv \sin(2\phi_1)$$

HFAG
Moriond 2012
PRELIMINARY

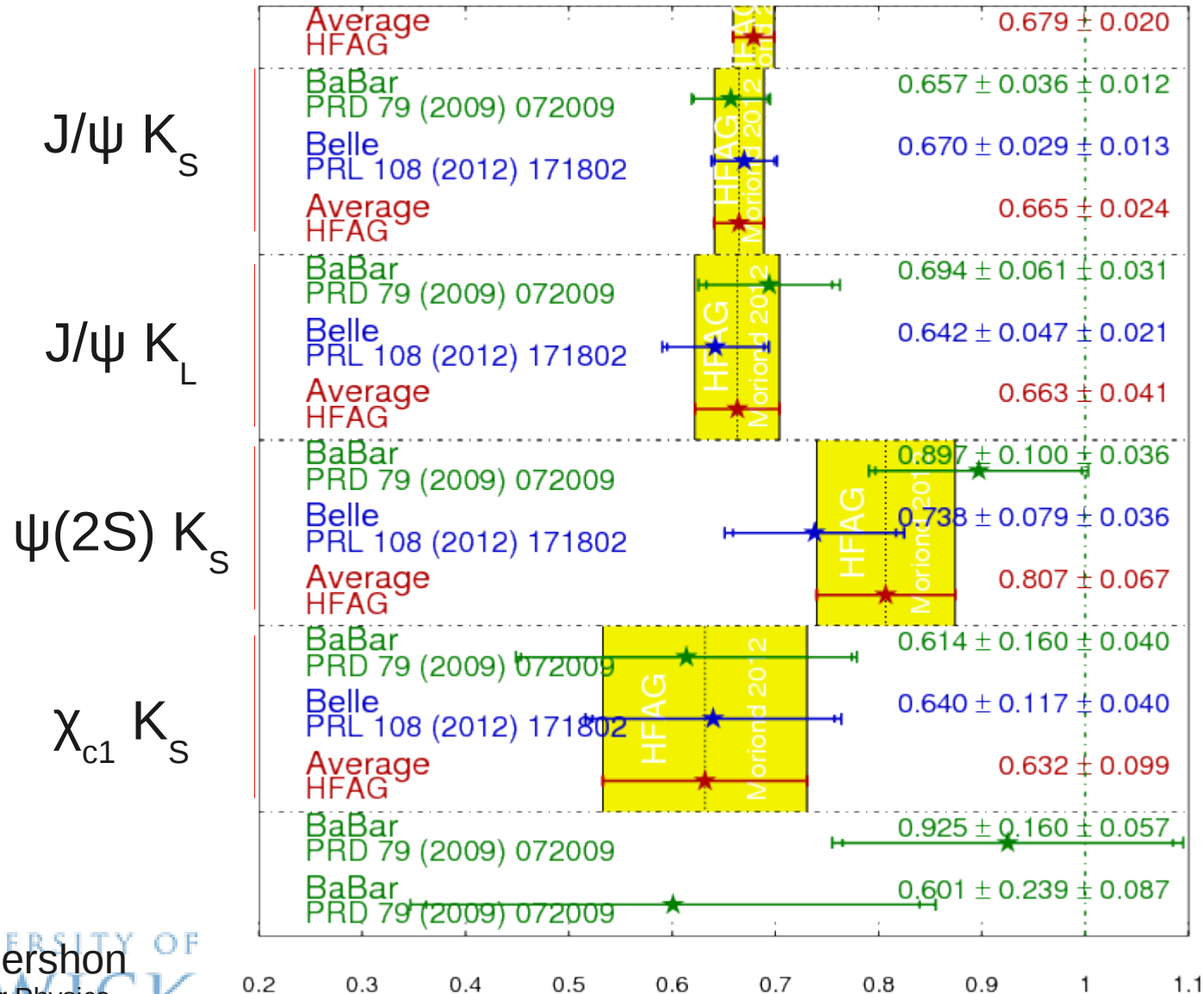

Measurement of α

- Similar analysis using $b \rightarrow u\bar{u}d$ decays (e.g. $B_d^0 \rightarrow \pi^+\pi^-$) probes $\pi-(\beta+\gamma) = \alpha$
 - but $b \rightarrow du\bar{u}$ penguin transitions contribute to same final states \Rightarrow “penguin pollution”
 - $C \neq 0 \Leftrightarrow$ direct CP violation can occur
 - $S \neq +\eta_{CP} \sin(2\alpha)$
- Two approaches (optimal approach combines both)
 - try to use modes with small penguin contribution
 - correct for penguin effect (isospin analysis)

PRL 65 (1990) 3381

Experimental Situation

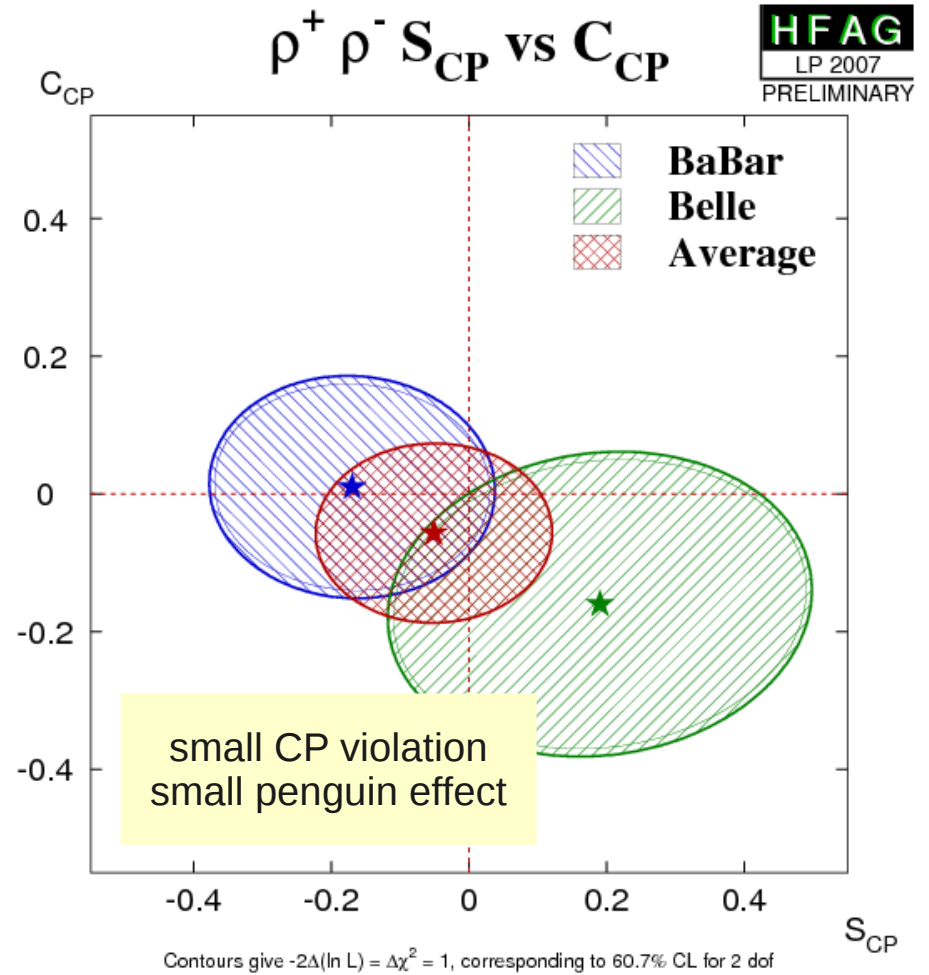
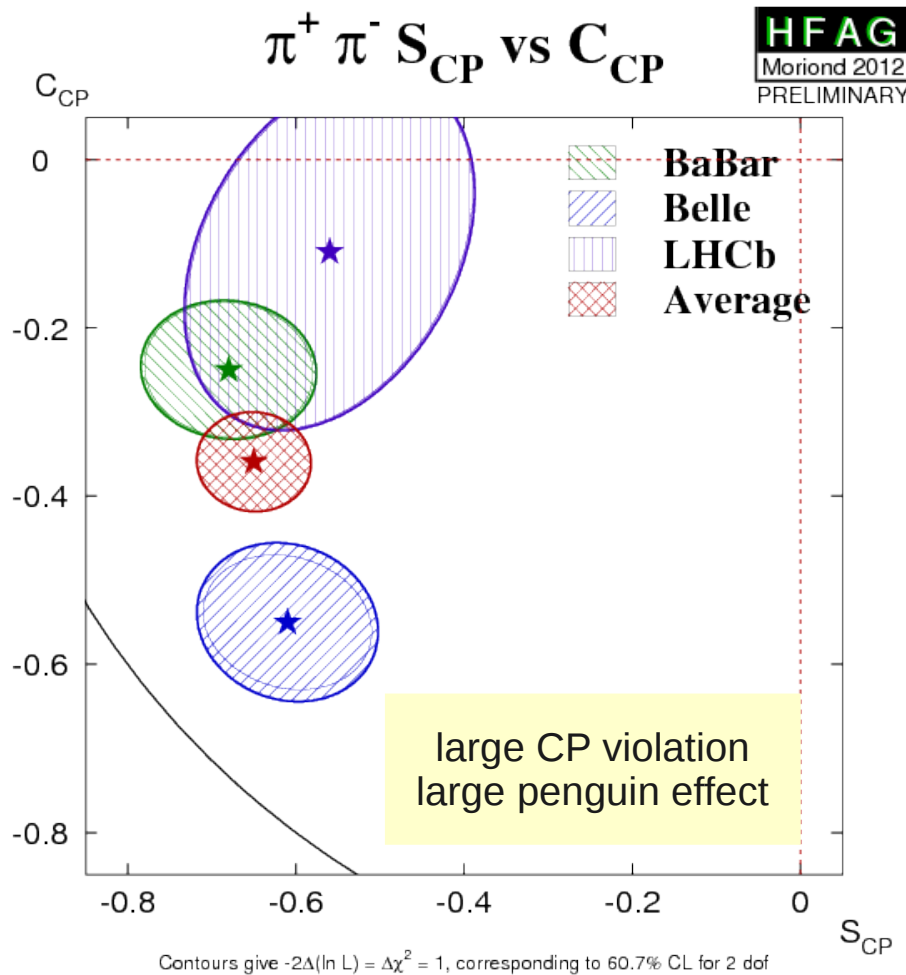

improved measurements needed!

Measurement of α

THESE SOLUTIONS RULED OUT BY OBSERVATION OF DIRECT CP VIOLATION IN $B^0 \rightarrow \pi^+\pi^-$

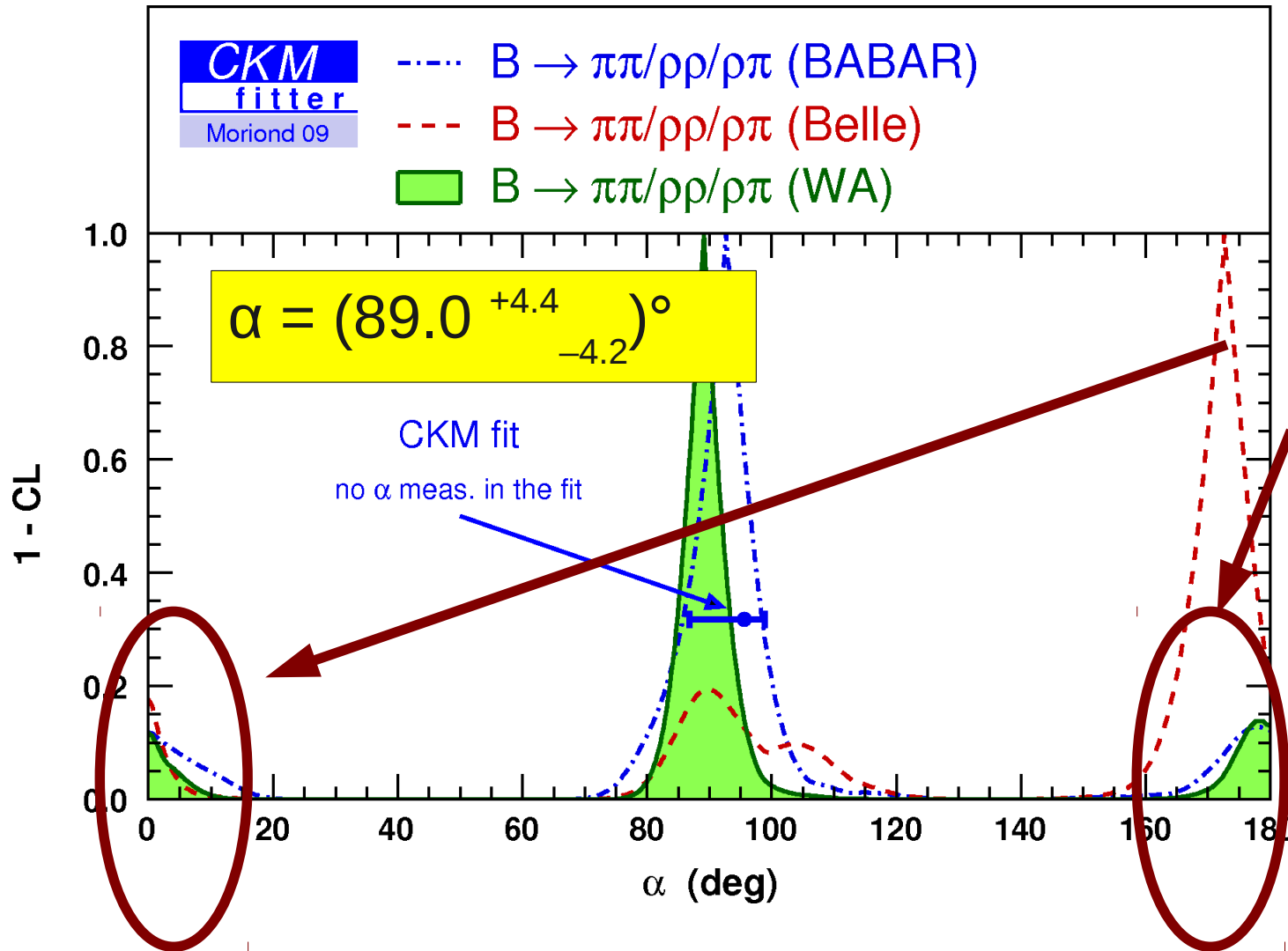

Is there any physical significance in the fact that $\alpha \approx 90^\circ$?

R_t side from B^0-B^0 mixing

World average based on many measurements

$$R_t = \left| \frac{V_{td} V_{tb}^*}{V_{cd} V_{cb}^*} \right| \quad \& \quad \frac{\Delta m_d}{\Delta m_s} = \frac{m_{B_d} f_{B_d}^2 \hat{B}_{B_d} |V_{td}|^2}{m_{B_s} f_{B_s}^2 \hat{B}_{B_s} |V_{ts}|^2}$$

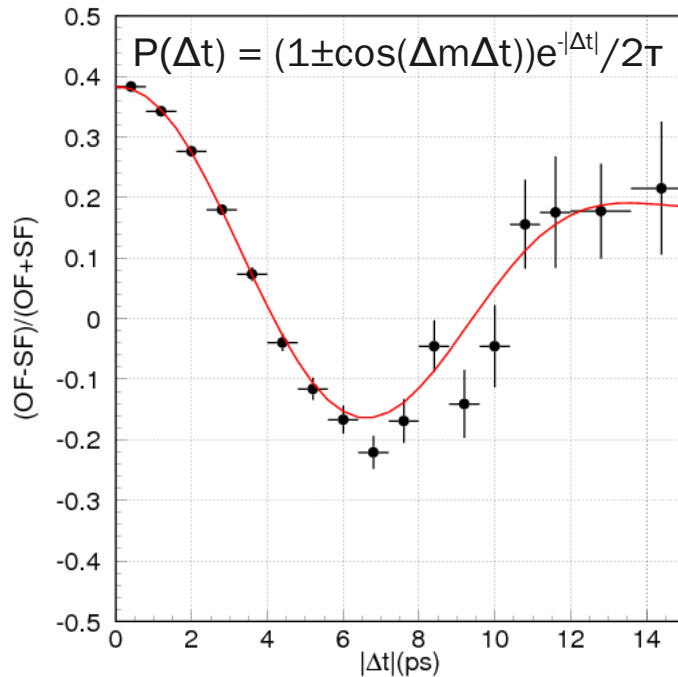

$$\Delta m_d = (0.511 \pm 0.005 \pm 0.006) \text{ ps}^{-1}$$

PRD 71, 072003 (2005)

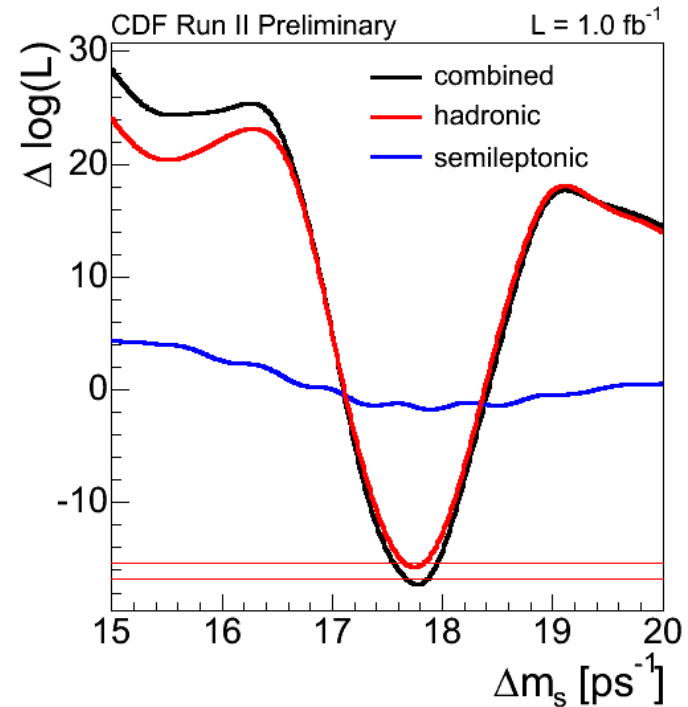

$$\Delta m_s = (17.77 \pm 0.10 \pm 0.07) \text{ ps}^{-1}$$

PRL 97, 242003 (2006)

$$\left| V_{td}/V_{ts} \right| = 0.211 \pm 0.001 \pm 0.005$$

↑ experimental uncertainty ↑ theoretical uncertainty

R_t side from B^0-B^0 mixing

$$R_t = \left| \frac{V_{td} V_{tb}^*}{V_{cd} V_{cb}^*} \right| \quad \& \quad \frac{\Delta m_d}{\Delta m_s} = \frac{m_{B_d} f_{B_d}^2 \hat{B}_{B_d} |V_{td}|^2}{m_{B_s} f_{B_s}^2 \hat{B}_{B_s} |V_{ts}|^2}$$

World average based on many measurements

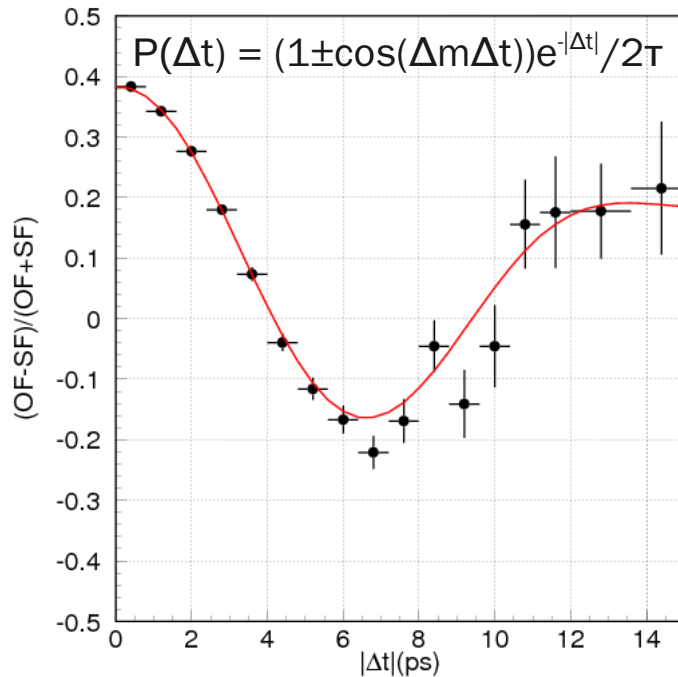

$$\Delta m_d = (0.511 \pm 0.005 \pm 0.006) \text{ ps}^{-1}$$

PRD 71, 072003 (2005)

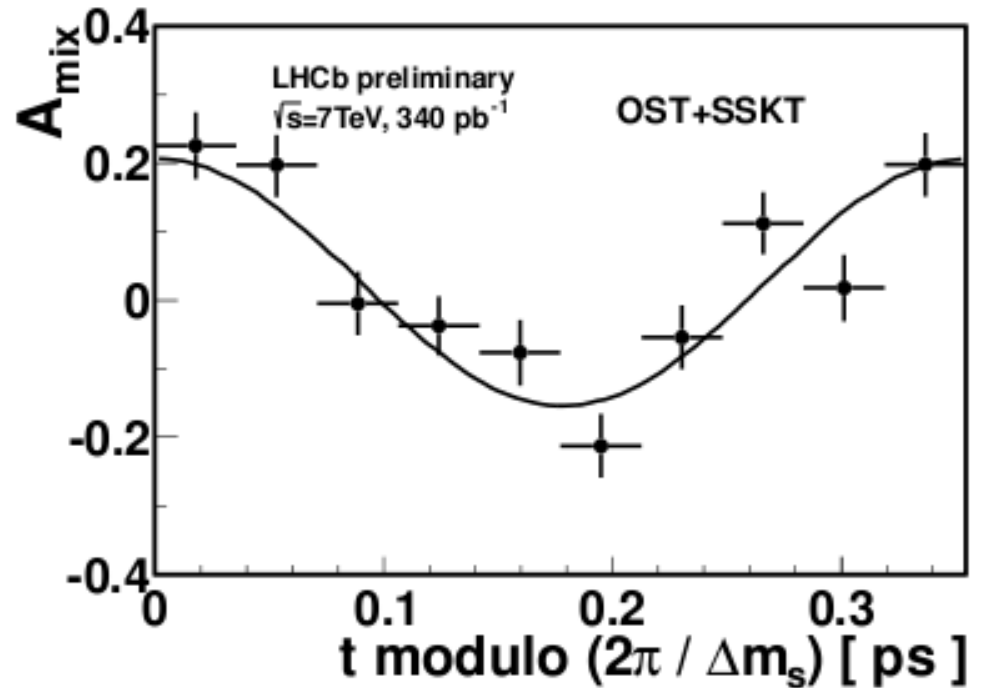

$$\Delta m_s = (17.725 \pm 0.041 \pm 0.026) \text{ ps}^{-1}$$

LHCb-CONF-2011-050

$$\left| V_{td}/V_{ts} \right| = 0.211 \pm 0.001 \pm 0.005$$

↑ experimental uncertainty ↑ theoretical uncertainty

R_u side from semileptonic decays

$$R_u = \left| \frac{V_{ud} V_{ub}^*}{V_{cd} V_{cb}^*} \right|$$

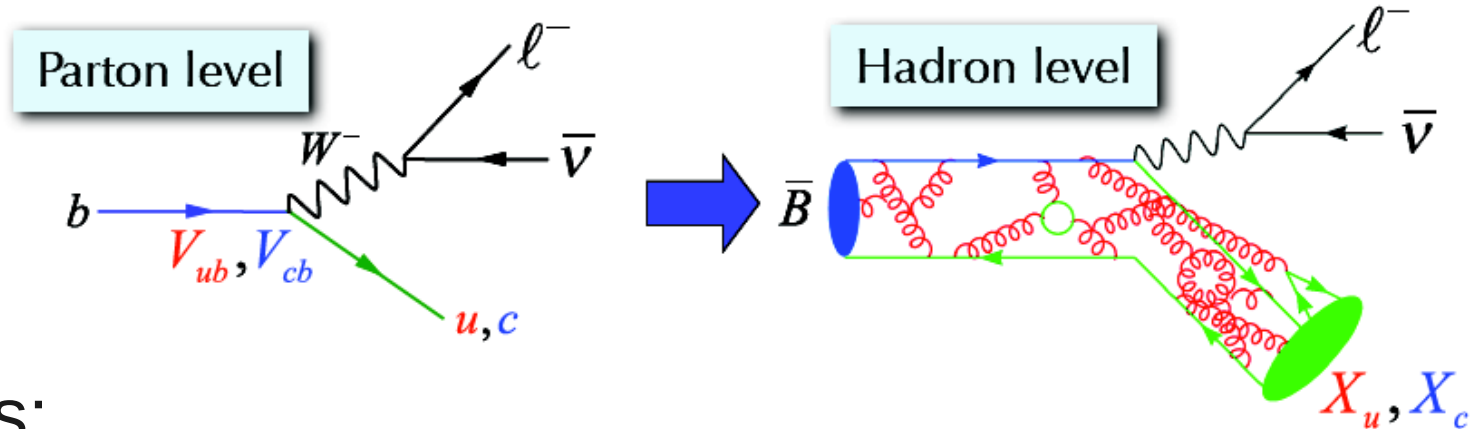

- Approaches:

- **exclusive semileptonic B decays**, eg. $B^0 \rightarrow \pi^- e^+ \nu$

- require knowledge of form factors

- can be calculated in lattice QCD at kinematical limit

- **inclusive semileptonic B decays**, eg. $B \rightarrow X_u e^+ \nu$

- clean theory, based on **O**perator **P**roduct **E**xpansion

- experimentally challenging:

- need to reject $b \rightarrow c$ background

- cuts re-introduce theoretical uncertainties

$|V_{ub}|$ from exclusive semileptonic decays

Current best measurements use $B^0 \rightarrow \pi^- l^+ \nu$

BaBar experiment
PRD 83 (2011) 052011
PRD 83 (2011) 032007

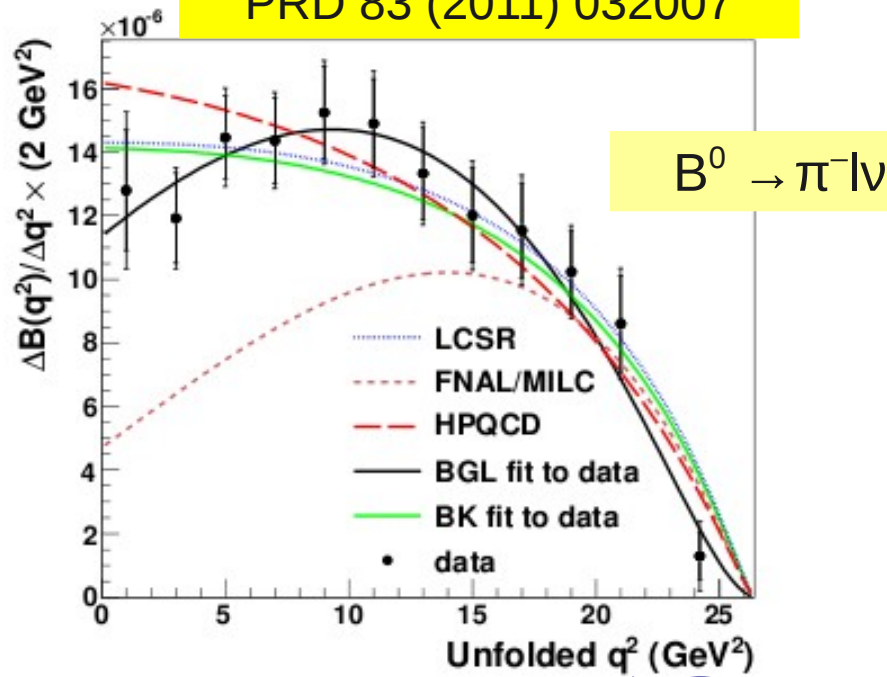

Belle experiment
PRD 83 (2011) 071101(R)

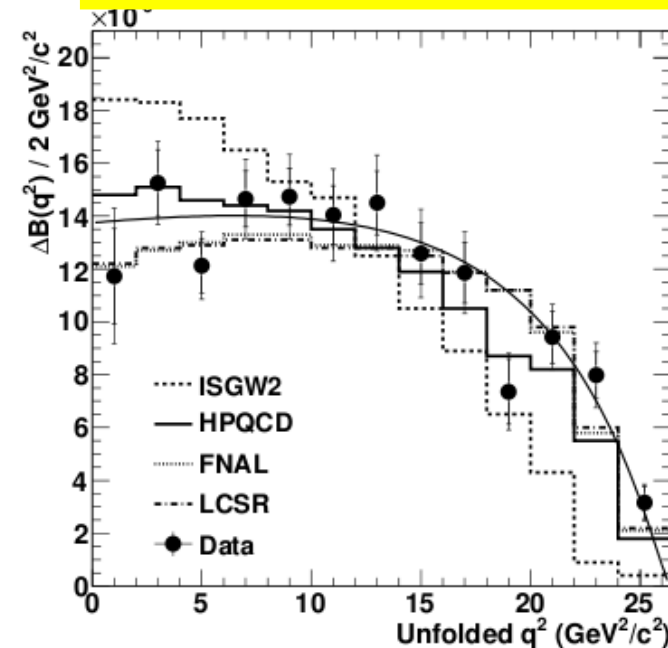

$$|V_{ub}| = (3.09 \pm 0.08 \pm 0.12^{+0.35}_{-0.29}) \times 10^{-3}$$

$$|V_{ub}| = (3.43 \pm 0.33) \times 10^{-3}$$

$|V_{ub}|$ from inclusive semileptonic decays

- Main difficulty to measure inclusive $B \rightarrow X_u l^+ \nu$
 - background from $B \rightarrow X_c l^+ \nu$
- Approaches
 - cut on E_l (lepton endpoint), q^2 ($l\nu$ invariant mass squared), $M(X_u)$, or some combination thereof
- Example: endpoint analysis

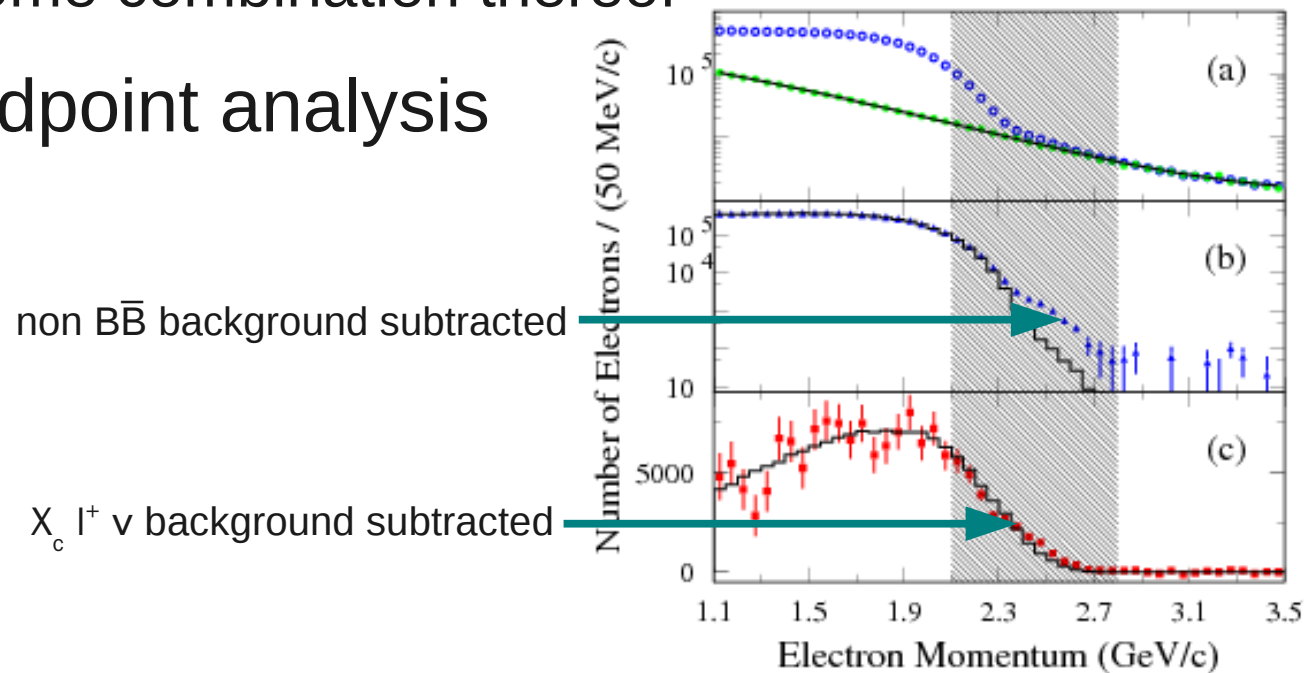

$|V_{ub}|$ inclusive - compilation

Different theoretical approaches (2 of 4 used by HFAG)

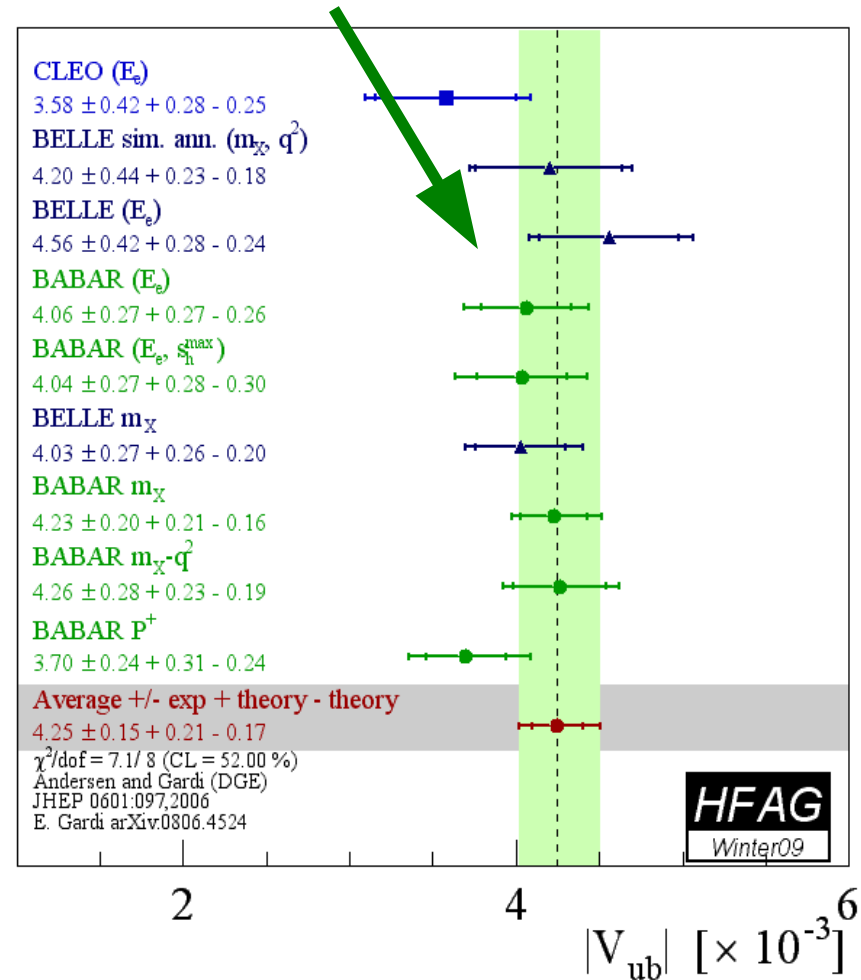
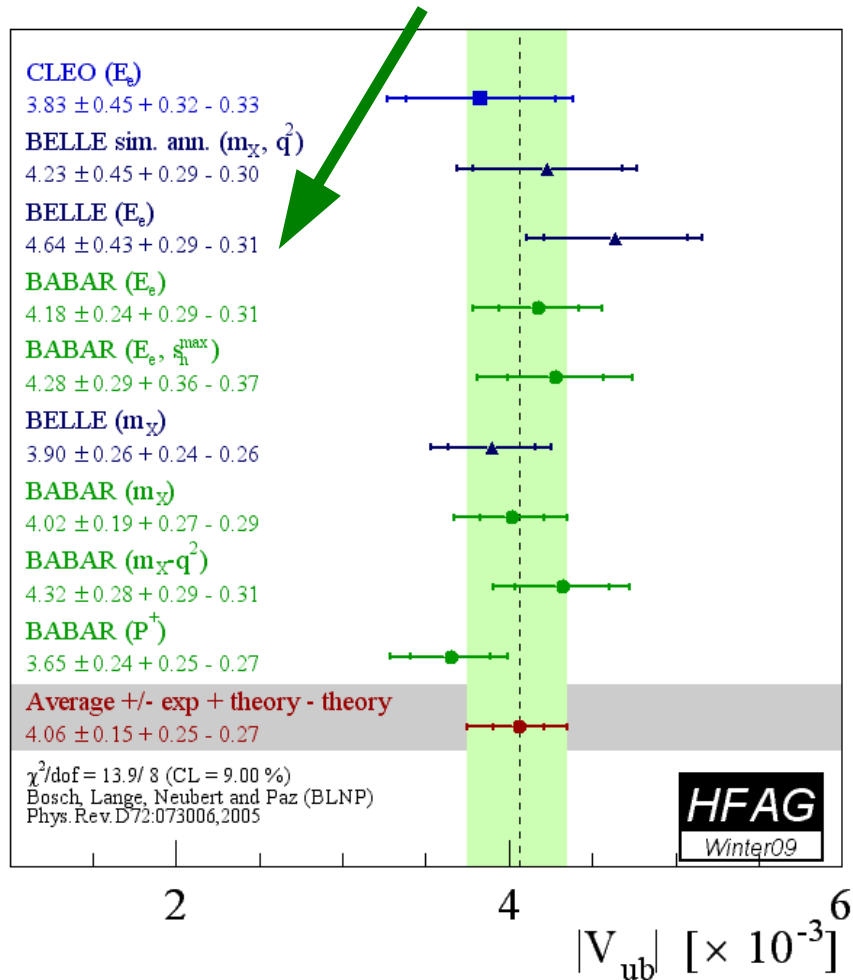

$|V_{ub}|$ average

- Averages on $|V_{ub}|$ from both exclusive and inclusive approaches
 - exclusive: $|V_{ub}| = (3.38 \pm 0.36) \times 10^{-3}$
 - inclusive: $|V_{ub}| = (4.27 \pm 0.38) \times 10^{-3}$
 - slight tension between these results
 - in both cases theoretical errors are dominant
 - but some “theory” errors can be improved with more data
 - PDG2010 does naïve average rescaling due to inconsistency to obtain $|V_{ub}| = (3.89 \pm 0.44) \times 10^{-3}$

Summary for today

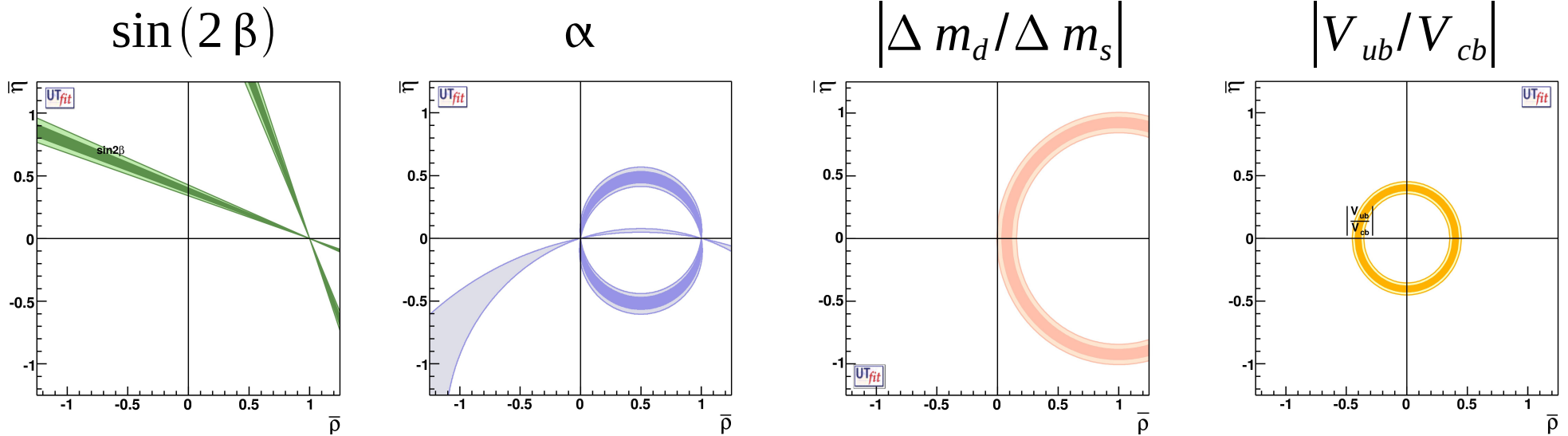

Adding a few other constraints we find

$$\bar{\rho} = 0.132 \pm 0.020$$

$$\bar{\eta} = 0.358 \pm 0.012$$

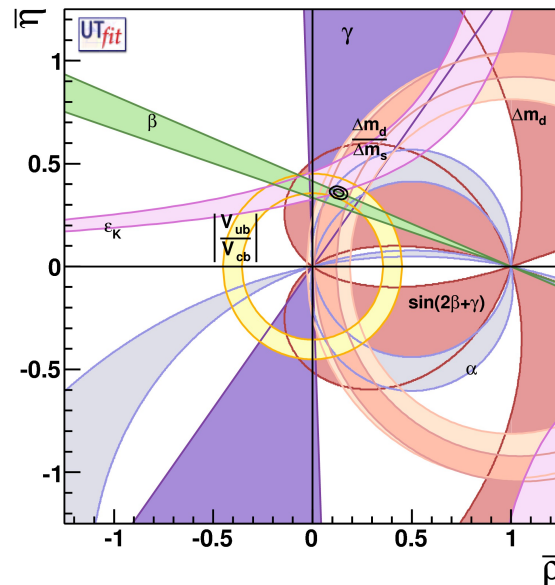

Consistent with Standard Model fit

- some “tensions”

Still plenty of room for new physics

Back up

Digression: Are there antimatter dominated regions of the Universe?

- Possible signals:
 - Photons produced by matter-antimatter annihilation at domain boundaries – not seen
 - Nearby anti-galaxies ruled out
 - Cosmic rays from anti-stars
 - Best prospect: Anti- ^4He nuclei
 - Searches ongoing ...

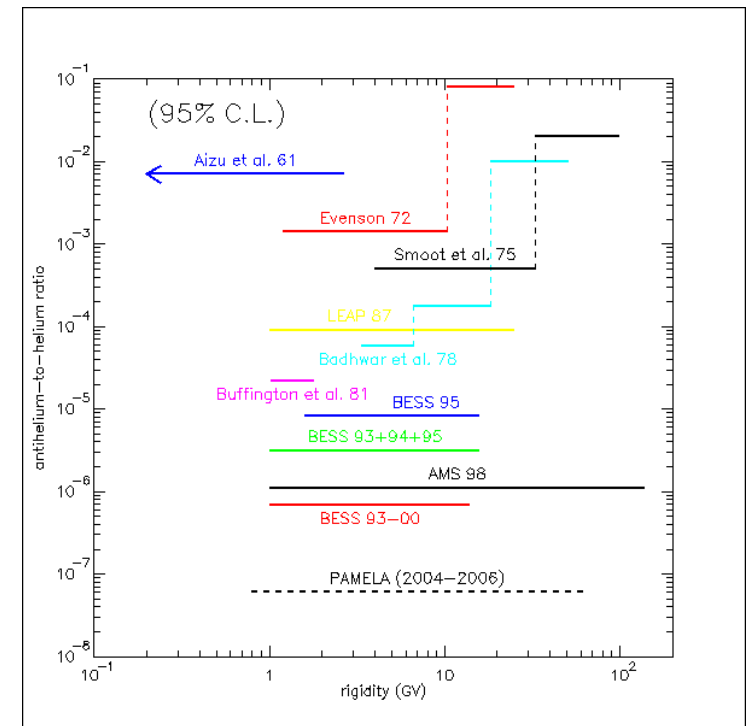

Searches for astrophysical antimatter

Alpha Magnetic Spectrometer Experiment
on board the **International Space Station**



**Payload for AntiMatter Exploration and
Light-nuclei Astrophysics** Experiment
on board the **Resurs-DK1** satellite



launch planned soon

launched 15th June 2006

Dynamic generation of BAU

- Suppose equal amounts of matter (X) and antimatter (\bar{X})
- X decays to
 - A (baryon number N_A) with probability p
 - B (baryon number N_B) with probability $(1-p)$
- \bar{X} decays to
 - \bar{A} (baryon number $-N_A$) with probability \bar{p}
 - \bar{B} (baryon number $-N_B$) with probability $(1-\bar{p})$
- Generated baryon asymmetry:
 - $\Delta N_{\text{TOT}} = N_A p + N_B (1-p) - N_A \bar{p} - N_B (1-\bar{p}) = (p - \bar{p}) (N_A - N_B)$
 - $\Delta N_{\text{TOT}} \neq 0$ requires $p \neq \bar{p}$ & $N_A \neq N_B$

CP violation and the BAU

- We can estimate the magnitude of the baryon asymmetry of the Universe caused by KM CP violation

$$\frac{n_B - n_{\bar{B}}}{n_\gamma} \approx \frac{n_B}{n_\gamma} \sim \frac{J \times P_u \times P_d}{M^{12}} \leftarrow \text{N.B. Vanishes for degenerate masses}$$

$$J = \cos(\theta_{12}) \cos(\theta_{23}) \cos^2(\theta_{13}) \sin(\theta_{12}) \sin(\theta_{23}) \sin(\theta_{13}) \sin(\delta)$$

$$P_u = (m_t^2 - m_c^2)(m_t^2 - m_u^2)(m_c^2 - m_u^2)$$

$$P_d = (m_b^2 - m_s^2)(m_b^2 - m_d^2)(m_s^2 - m_d^2)$$

PRL 55 (1985) 1039

- The **Jarlskog** parameter J is a parametrization invariant measure of CP violation in the quark sector: $J \sim O(10^{-5})$
- The mass scale M can be taken to be the electroweak scale $O(100 \text{ GeV})$
- This gives an asymmetry $O(10^{-17})$
 - **much much below** the observed value of $O(10^{-10})$

Constraints on NP from mixing

- All measurements of Δm & $\Delta \Gamma$ consistent with SM
 - K^0, D^0, B_d^0 and B_s^0
- This means $|A_{NP}| < |A_{SM}|$ where $\mathcal{A}_{SM}^{\Delta F=2} \approx \frac{G_F^2 m_t^2}{16\pi^2} (V_{ti}^* V_{tj})^2 \times \langle \bar{M} | (\bar{Q}_{Li} \gamma^\mu Q_{Lj})^2 | M \rangle \times F \left(\frac{M_W^2}{m_t^2} \right)$
- Express NP as perturbation to the SM Lagrangian
 - couplings c_i and scale $\Lambda > m_W$ $\mathcal{L}_{\text{eff}} = \mathcal{L}_{\text{SM}} + \sum \frac{c_i^{(d)}}{\Lambda^{(d-4)}} O_i^{(d)}(\text{SM fields})$
- For example, SM like (left-handed) operators $\Delta \mathcal{L}^{\Delta F=2} = \sum_{i \neq j} \frac{c_{ij}}{\Lambda^2} (\bar{Q}_{Li} \gamma^\mu Q_{Lj})^2$

arXiv:1002.0900

Operator	Bounds on Λ in TeV ($c_{ij} = 1$)		Bounds on c_{ij} ($\Lambda = 1$ TeV)		Observables
	Re	Im	Re	Im	
$(\bar{s}_L \gamma^\mu d_L)^2$	9.8×10^2	1.6×10^4	9.0×10^{-7}	3.4×10^{-9}	$\Delta m_K; \epsilon_K$
$(\bar{s}_R d_L)(\bar{s}_L d_R)$	1.8×10^4	3.2×10^5	6.9×10^{-9}	2.6×10^{-11}	$\Delta m_K; \epsilon_K$
$(\bar{c}_L \gamma^\mu u_L)^2$	1.2×10^3	2.9×10^3	5.6×10^{-7}	1.0×10^{-7}	$\Delta m_D; q/p , \phi_D$
$(\bar{c}_R u_L)(\bar{c}_L u_R)$	6.2×10^3	1.5×10^4	5.7×10^{-8}	1.1×10^{-8}	$\Delta m_D; q/p , \phi_D$
$(\bar{b}_L \gamma^\mu d_L)^2$	5.1×10^2	9.3×10^2	3.3×10^{-6}	1.0×10^{-6}	$\Delta m_{B_d}; S_{\psi K_S}$
$(\bar{b}_R d_L)(\bar{b}_L d_R)$	1.9×10^3	3.6×10^3	5.6×10^{-7}	1.7×10^{-7}	$\Delta m_{B_d}; S_{\psi K_S}$
$(\bar{b}_L \gamma^\mu s_L)^2$		1.1×10^2		7.6×10^{-5}	Δm_{B_s}
$(\bar{b}_R s_L)(\bar{b}_L s_R)$		3.7×10^2		1.3×10^{-5}	Δm_{B_s}

New Physics Flavour Problem

- Limits on NP scale at least 100 TeV for generic couplings
 - model-independent argument, also for rare decays
- But we need NP at the TeV scale to solve the hierarchy problem (and to provide DM candidate, etc.)
- So we need NP flavour-changing couplings to be small
- Why?
 - minimal flavour violation?
 - perfect alignment of flavour violation in NP and SM
 - some other approximate symmetry?
 - flavour structure tells us about physics at very high scales
- There are still important observables that are not yet well-tested

NPB 645 (2002) 155