

# Heavy Flavour Physics at the LHC

Tim Gershon  
University of Warwick

6 November 2013

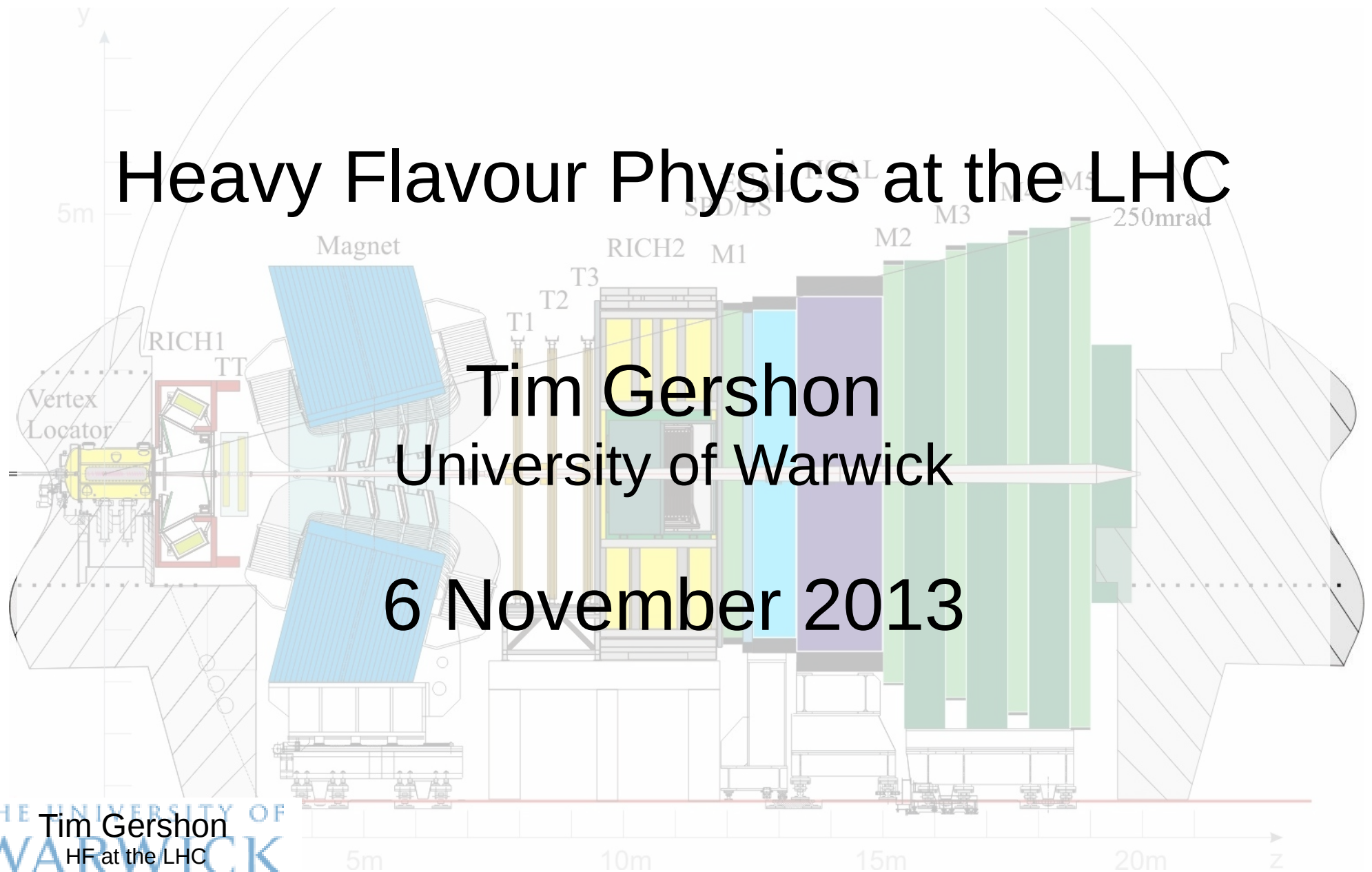

# Outline

- Why flavour physics in the LHC era?
- Selected highlights of recent results
  - Production and spectroscopy
  - CP violation and the Unitarity Triangle
  - Rare decays
- Future prospects

# Dirac's prescience

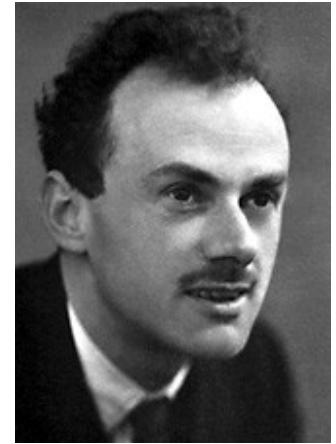

## Concluding words of 1933 Nobel lecture

“If we accept the view of **complete symmetry between positive and negative electric charge** so far as concerns the fundamental laws of Nature, we must regard it rather as an accident that the Earth (and presumably the whole solar system), contains a **preponderance of negative electrons and positive protons**. It is quite possible that for some of the stars it is the other way about, these stars being built up mainly of positrons and negative protons. In fact, there may be half the stars of each kind. **The two kinds of stars would both show exactly the same spectra**, and there would be no way of distinguishing them by present astronomical methods.”

# Where is the antimatter?



# CP violation and the matter-antimatter asymmetry

- Two widely known facts
  - 1) CP violation is one of 3 “Sakharov conditions” necessary for the evolution of a baryon asymmetry in the Universe
  - 2) The Standard Model (CKM) CP violation is not sufficient to explain the observed asymmetry
- Therefore, there must be more sources of CP violation in nature ... but where?
  - extended quark sector, lepton sector (leptogenesis), supersymmetry, anomalous gauge couplings, extended Higgs sector, quark-gluon plasma, flavour-diagonal phases, ...
- Testing the consistency of the CKM mechanism provides the best chance to find new sources of CP violation today

# What causes the difference between matter and antimatter?

- In the SM, fermion masses arise from the Yukawa couplings of the quarks and charged leptons to the Higgs field (taking  $m_\nu=0$ )
- The CKM matrix arises from the relative misalignment of the Yukawa matrices for the up- and down-type quarks

$$V_{CKM} = U_u U_d^+$$

U matrices from diagonalisation of mass matrices

- It is a 3x3 complex **unitary** matrix
  - described by 9 (real) parameters
  - 5 can be absorbed as phase differences between the quark fields
  - 3 can be expressed as (Euler) mixing angles
  - the fourth makes the CKM matrix complex (i.e. gives it a phase)
    - weak interaction couplings differ for quarks and antiquarks
    - CP violation

# The Cabibbo-Kobayashi-Maskawa Quark Mixing Matrix



$$V_{CKM} = \begin{pmatrix} V_{ud} & V_{us} & V_{ub} \\ V_{cd} & V_{cs} & V_{cb} \\ V_{td} & V_{ts} & V_{tb} \end{pmatrix}$$

- A 3x3 unitary matrix
- Described by 4 real parameters – **allows CP violation**
  - PDG (Chau-Keung) parametrisation:  $\theta_{12}$ ,  $\theta_{23}$ ,  $\theta_{13}$ ,  $\delta$
  - Wolfenstein parametrisation:  $\lambda$ ,  $A$ ,  $\rho$ ,  $\eta$
- **Highly predictive**

# Quark flavour mixing a.k.a. CKM phenomenology

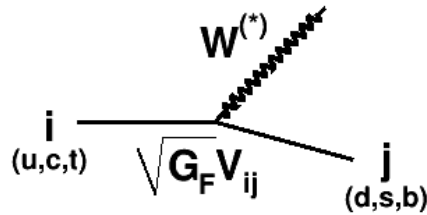

$$V_{CKM} = \begin{pmatrix} V_{ud} & V_{us} & V_{ub} \\ V_{cd} & V_{cs} & V_{cb} \\ V_{td} & V_{ts} & V_{tb} \end{pmatrix} = \begin{pmatrix} 1 - \frac{1}{2}\lambda^2 & \lambda & A\lambda^3(\rho - i\eta) \\ -\lambda & 1 - \frac{1}{2}\lambda^2 & A\lambda^2 \\ A\lambda^3(1 - \rho - i\eta) & -A\lambda^2 & 1 \end{pmatrix} + O(\lambda^4)$$

N.B.  $V_{ts}$  has imaginary part at  $O(\lambda^4)$

- CKM theory is highly predictive
  - huge range of phenomena over a massive energy scale predicted by only 4 independent parameters (+ QCD)
- CKM matrix is hierarchical
  - theorised connections to quark mass hierarchies, or (dis-)similar patterns in the lepton sector
    - origin of CKM matrix from diagonalisation of Yukawa (mass) matrices after electroweak symmetry breaking
  - distinctive flavour sector of Standard Model not necessarily replicated in extended theories → strong constraints on models
- CKM mechanism introduces CP violation
  - only source of CP violation in the Standard Model ( $m_\nu = \theta_{QCD} = 0$ )



# Two routes to heaven for flavour physics

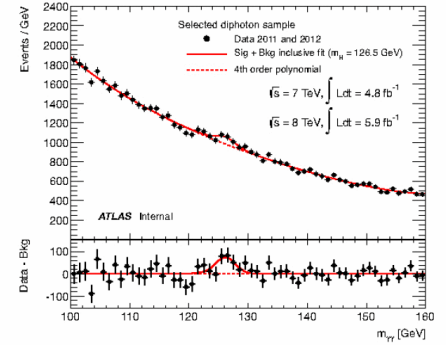

CP violation  
(extra sources must exist)

But

- No guarantee of the scale
- No guarantee of effects in the quark sector
- Realistic prospects for CPV measurement in  $\nu$ s due to large  $\theta_{13}$

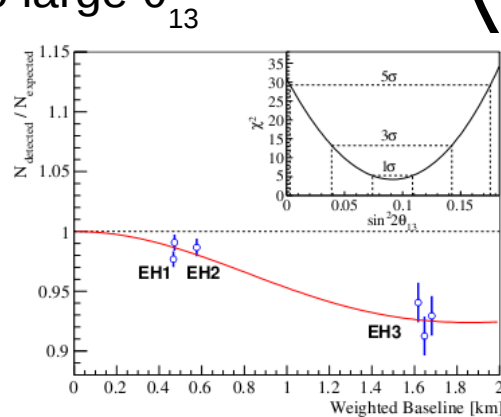

SM

Rare decays  
(strong theoretical arguments)

But

- How high is the NP scale?
- Why have FCNC effects not been seen?

NP

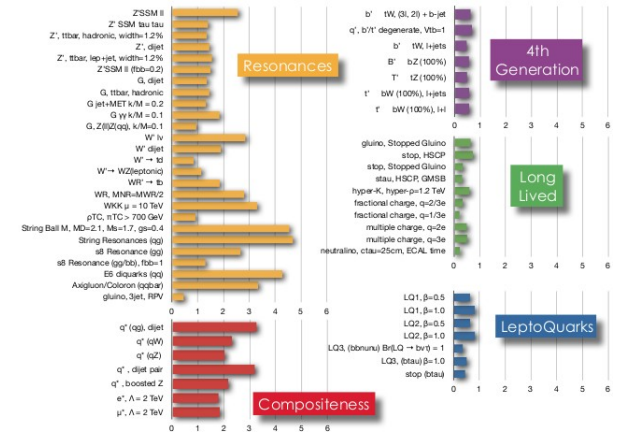

Absence of NP signals at ATLAS/CMS → argument for searches via rare decays stronger

# New Physics Flavour Problem

- Limits on NP scale at least 100 TeV for generic couplings
  - model-independent argument, also for rare decays
- But we need NP at the “TeV scale” to solve the hierarchy problem (and to provide DM candidate, etc.)
- So we need NP flavour-changing couplings to be small
- Why?
  - minimal flavour violation?
    - perfect alignment of flavour violation in NP and SM
  - some other approximate symmetry?
  - flavour structure tells us about physics at very high scales
- Many important observables are not sufficiently well-tested

NPB 645 (2002) 155

# Search for $\mu^+ \rightarrow e^+ \gamma$

$\mu^+ \rightarrow e^+ \gamma$

- positive muons  $\rightarrow$  no muonic atoms
- continuous (DC) muon beam at PSI  $\rightarrow$  minimise accidental coincidences

MEG arXiv:1303.0754

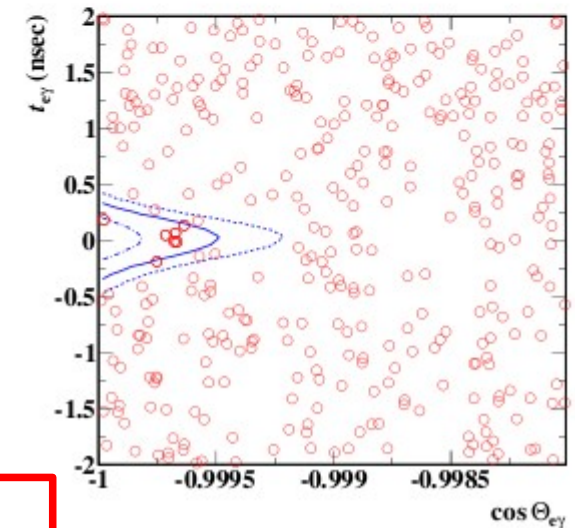
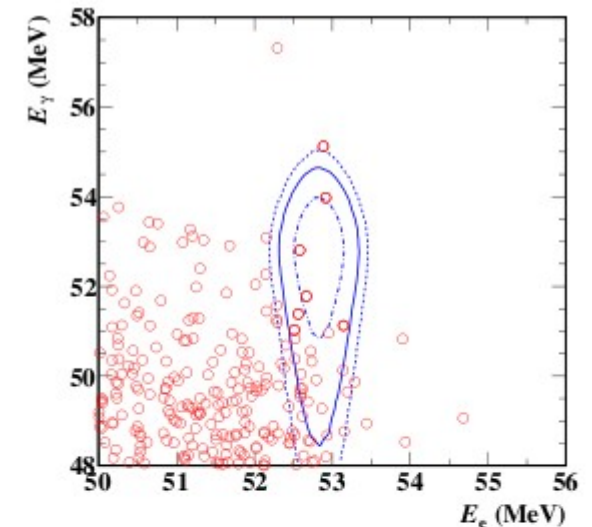
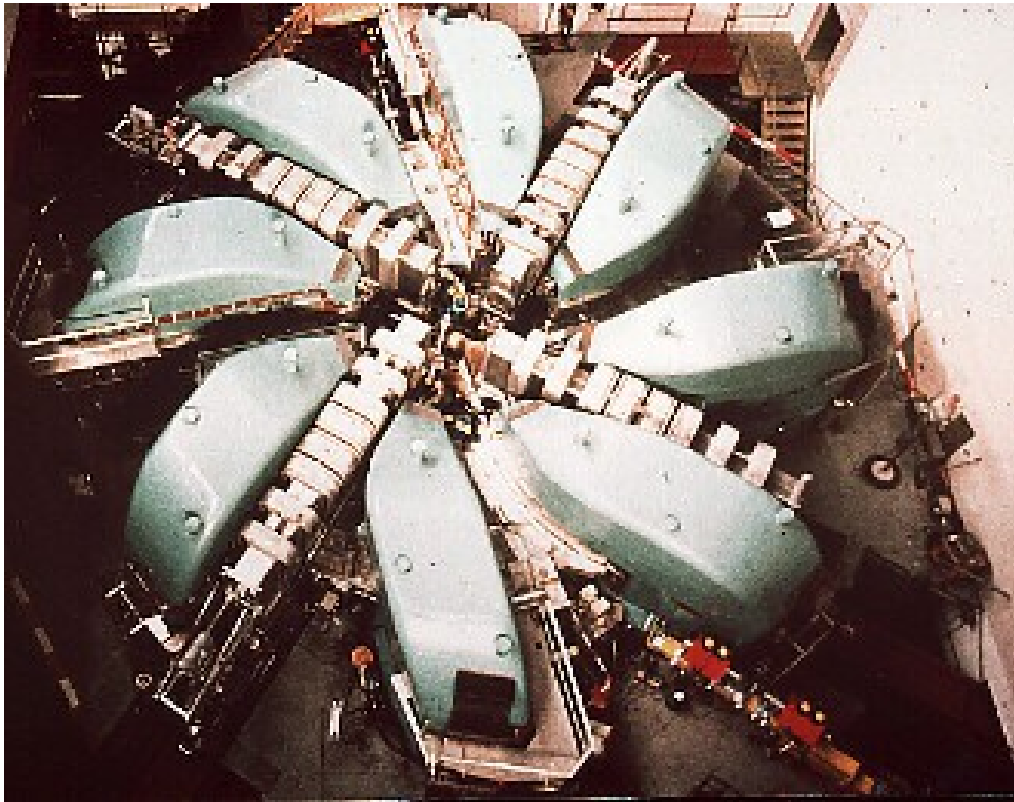

$$B(\mu^+ \rightarrow e^+ \gamma) < 5.7 \cdot 10^{-13} \text{ @ 90\% CL}$$

# Why flavour physics in the LHC era?

- There is still much physics to be done with the datasets of BaBar, Belle, CDF, D0, CLEO, BES, etc.
  - Discovery potential complementary to other experiments
  - New experiments in the charged lepton sector add additional potential
- LHC is the world's most copious source of heavy flavoured fermions
  - LHCb experiment instruments the forward region for best b & c physics capability
    - extends the physics reach of the LHC programme, exploring *beyond* the energy frontier
  - ATLAS and CMS experiments also have some capability in this sector
- In addition to studying flavour-changing phenomena, excellent opportunities to study unresolved issues in QCD
  - Puzzles concerning heavy flavour production and spectroscopy

# Flavour physics at hadron colliders

	$e^+e^- \rightarrow \Upsilon(4S) \rightarrow B\bar{B}$ PEP-II, KEKB	$p\bar{p} \rightarrow b\bar{b}X$ ( $\sqrt{s} = 2 \text{ TeV}$ ) Tevatron	$pp \rightarrow b\bar{b}X$ ( $\sqrt{s} = 14 \text{ TeV}$ ) LHC
Production cross-section	1 nb	$\sim 100 \mu\text{b}$	$\sim 500 \mu\text{b}$
Typical $b\bar{b}$ rate	10 Hz	$\sim 100 \text{ kHz}$	$\sim 500 \text{ kHz}$
Pile-up	0	1.7	0.5–20
$b$ hadron mixture	$B^+B^-$ (50%), $B^0\bar{B}^0$ (50%)	$B^+$ (40%), $B^0$ (40%), $B_s^0$ (10%), $\Lambda_b^0$ (10%), others ( $< 1\%$ )	
$b$ hadron boost	small ( $\beta\gamma \sim 0.5$ )	large ( $\beta\gamma \sim 100$ )	
Underlying event	$B\bar{B}$ pair alone	Many additional particles	
Production vertex	Not reconstructed	Reconstructed from many tracks	
$B^0-\bar{B}^0$ pair production	Coherent (from $\Upsilon(4S)$ decay)	Incoherent	
Flavour tagging power	$\epsilon D^2 \sim 30\%$	$\epsilon D^2 \sim 5\%$	

# The LHCb detector

- In high energy collisions,  $b\bar{b}$  pairs produced predominantly in forward or backward directions
- LHCb is a forward spectrometer
  - a new concept for HEP experiments

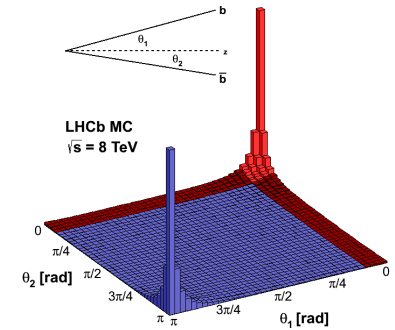

The LHCb Detector  
 JINST 3 (2008) S08005

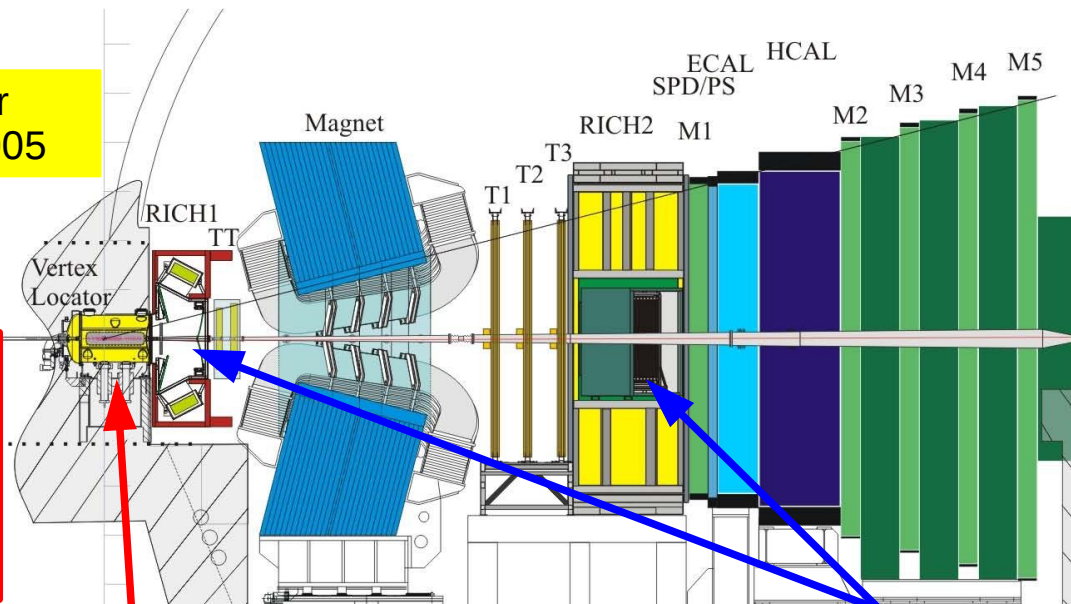

Precision primary and secondary vertex measurements

Excellent  $K/\pi$  separation capability

# The LHCb trigger

JINST 8 (2013) P04022

## Challenge is

- to efficiently select most interesting B decays
- while maintaining manageable data rates

## Main backgrounds

- “minimum bias” inelastic pp scattering
- other charm and beauty decays

## Handles

- high  $p_T$  signals (muons)
- displaced vertices

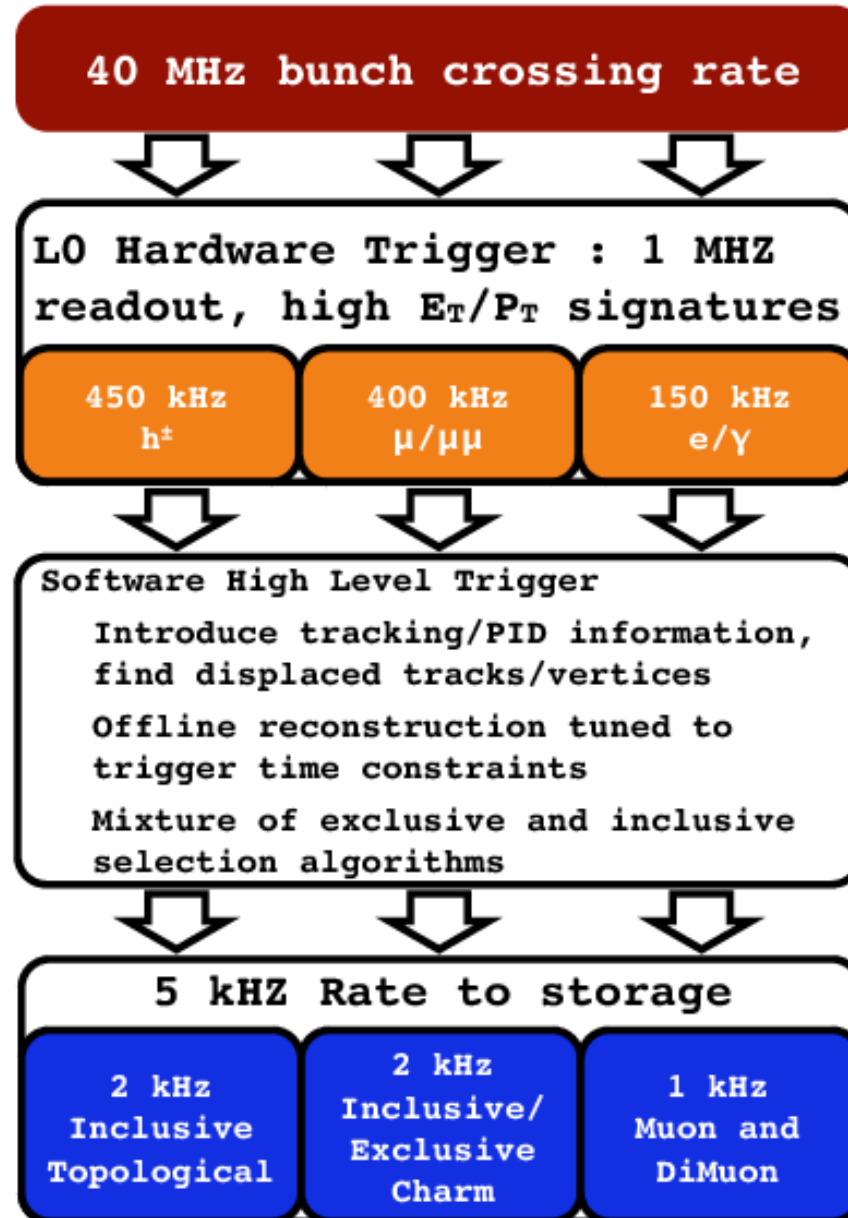

# Selected highlights of results Production and spectroscopy



# Observations of new states

(no, not the Higgs)

“Observation of a New  $\chi_b$  State in Radiative Transitions to  $Y(1S)$  and  $Y(2S)$  at ATLAS”

Phys. Rev. Lett. 108 (2012) 152001

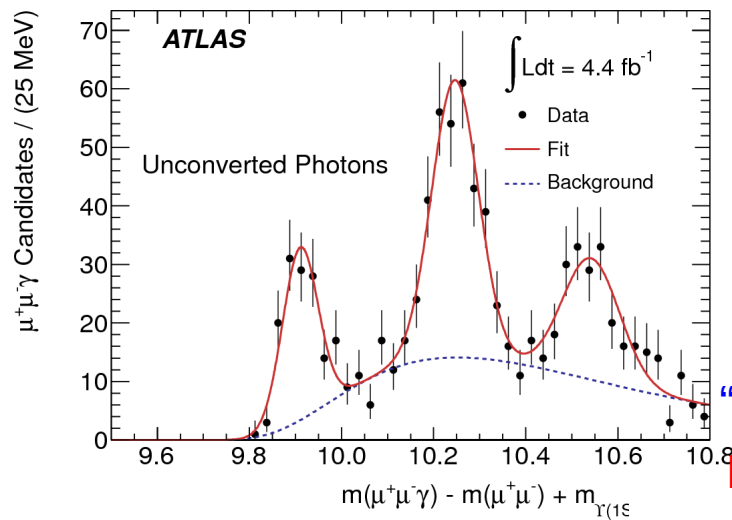

“Observation of excited  $\Lambda_b^0$  baryons”

Phys. Rev. Lett. 109 (2012) 172003

“Observation of a New  $\Xi_b$  Baryon”

Phys. Rev. Lett. 108 (2012) 252002

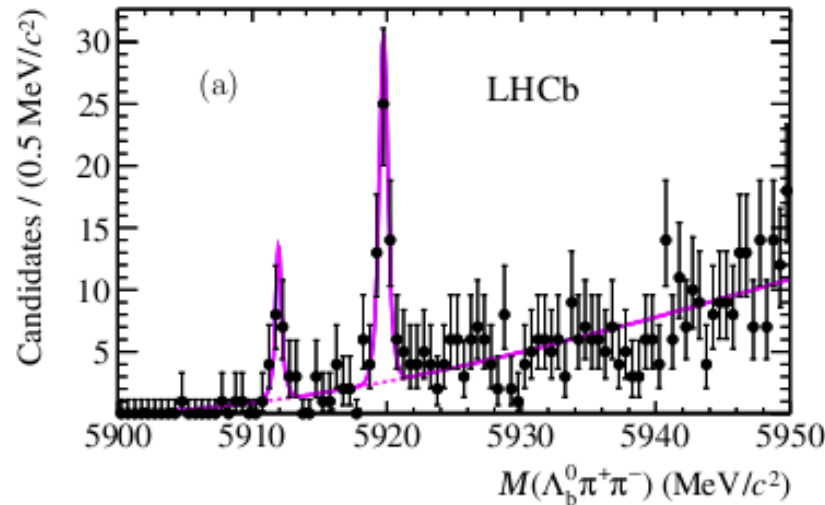
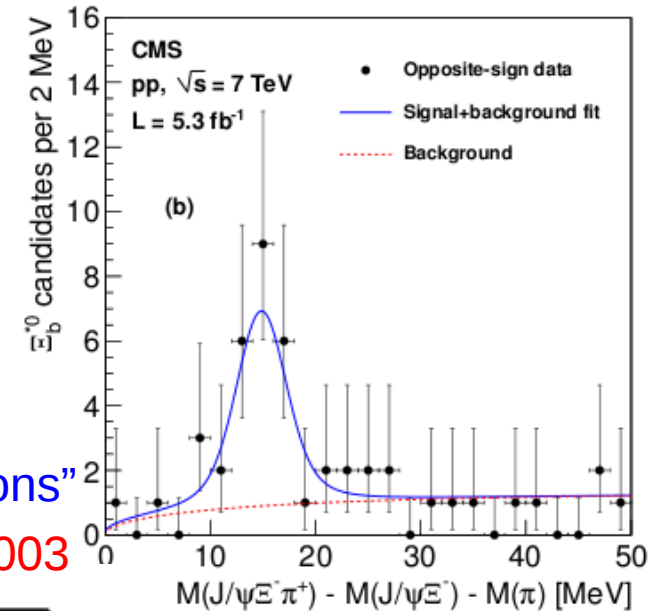

# Quantum numbers of the X(3872)

LHCb PRL 110 (2013) 222001

- X(3872) discovered in  $B \rightarrow XK$ , with  $X \rightarrow J/\psi\pi\pi$  (Belle PRL 91 (2003) 262001)
- **Does not fit well with expectations for conventional states**
  - above open charm threshold but narrow
- $J^{PC}$  limited to  $1^{++}$  or  $2^{-+}$  by previous analyses (CDF PRL 98 (2007) 132002)
- LHCb analysis uses production from B decay, and full (5D) angular distribution of decay chain (assuming  $J^{PC}(\pi\pi) = 1^{-}$ ; see also CMS arXiv:1302.3968)
- Likelihood ratio test used to compare hypotheses

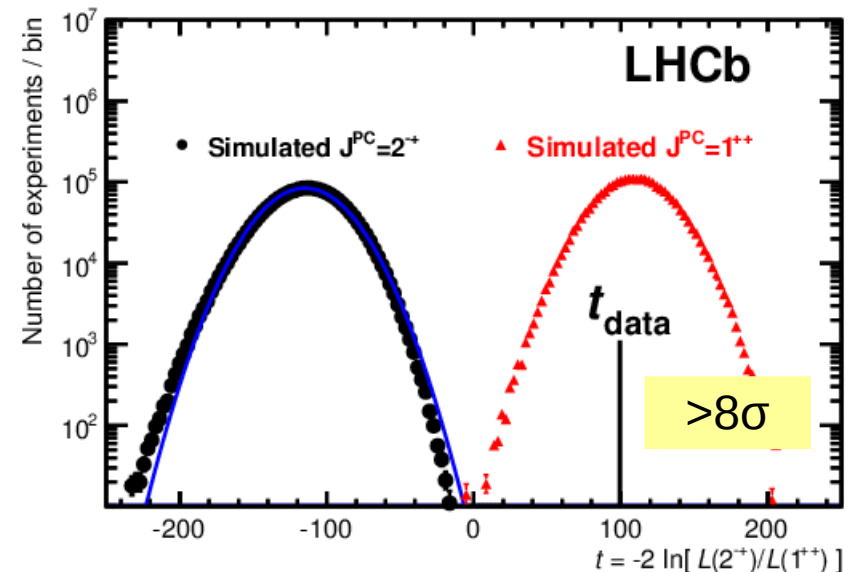
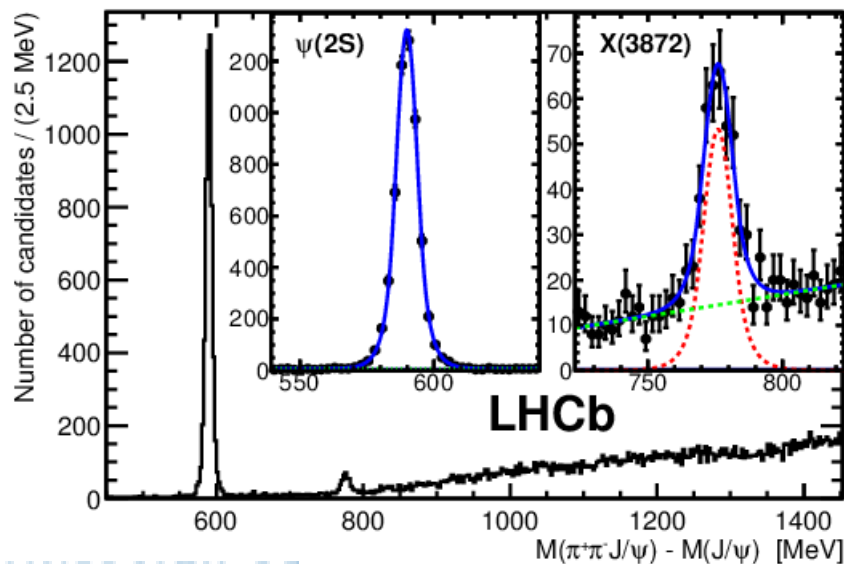

$J^{PC} = 1^{++}$  supports molecular interpretation of X(3872)  
... but then how to explain production in hadron collisions?

# Selected highlights of results CP violation and the Unitarity Triangle

# The Unitarity Triangle

- The CKM matrix must be unitary

$$V_{CKM}^+ V_{CKM} = V_{CKM} V_{CKM}^+ = 1$$

- Provides numerous tests of constraints between independent observables, such as

$$|V_{ud}|^2 + |V_{us}|^2 + |V_{ub}|^2 = 1$$

$$V_{ud} V_{ub}^* + V_{cd} V_{cb}^* + V_{td} V_{tb}^* = 0$$

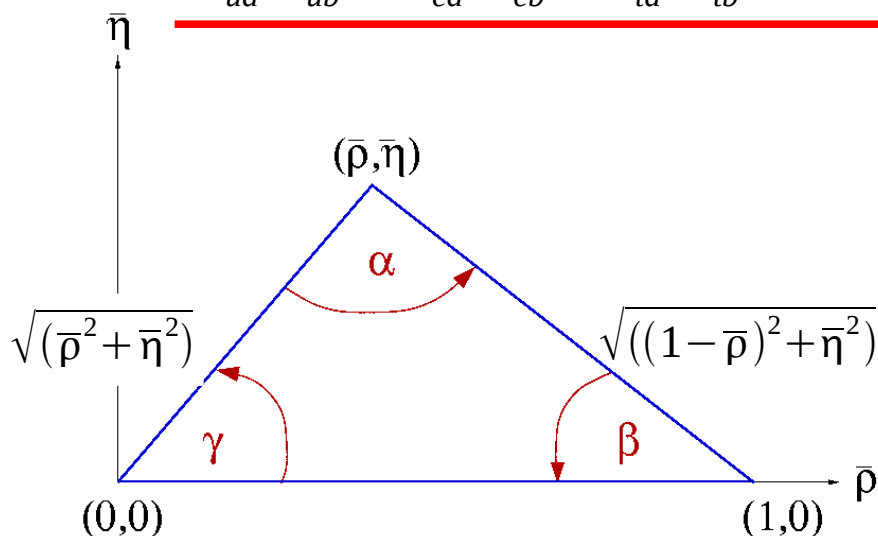

<http://ckmfitter.in2p3.fr>  
see also <http://www.utfit.org>

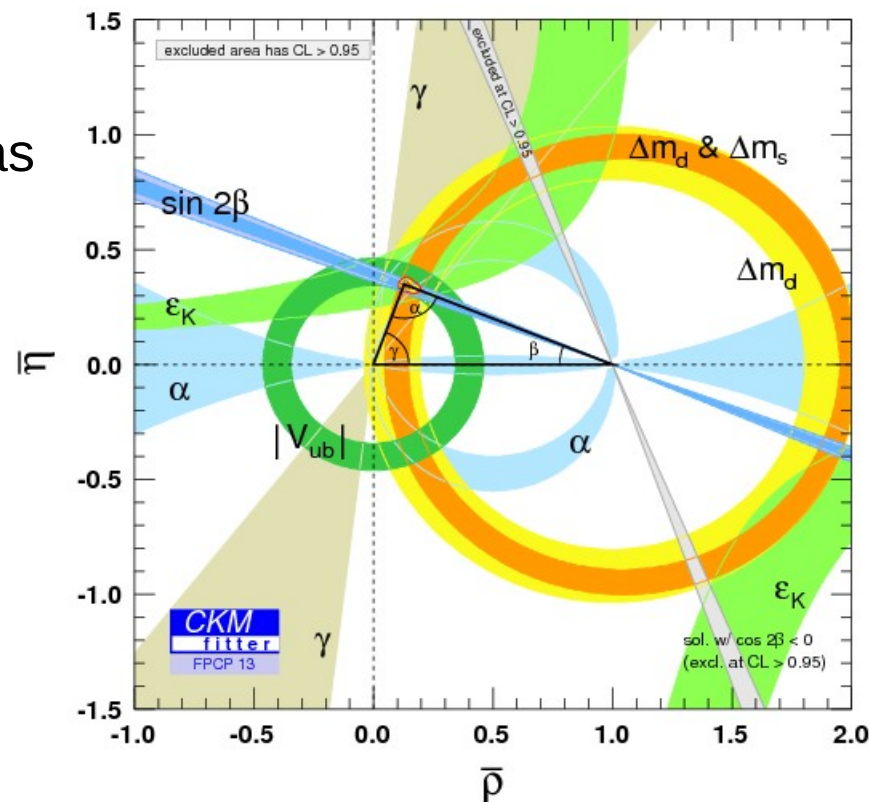

Consistency of measurements tests the Standard Model and provides model-independent constraints on New Physics

# Categories of CP violation

- Consider decay of neutral particle to a CP eigenstate

$$\lambda_{CP} = \frac{q}{p} \frac{\bar{A}}{A}$$

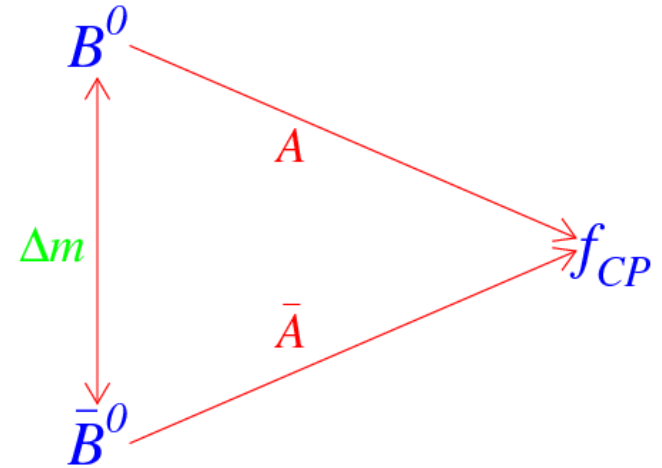

$$\left| \frac{q}{p} \right| \neq 1$$

CP violation in mixing

$$\left| \frac{\bar{A}}{A} \right| \neq 1$$

CP violation in decay (direct CPV)

$$\Im \left( \frac{q}{p} \frac{\bar{A}}{A} \right) \neq 0$$

CP violation in interference between mixing and decay

# Direct CP violation

- Condition for DCPV:  $|\bar{A}/A| \neq 1$
- Need  $\bar{A}$  and  $A$  to consist of (at least) two parts
  - with different weak ( $\varphi$ ) and strong ( $\delta$ ) phases
- Often realised by “tree” and “penguin” diagrams

$$A = |T|e^{i(\delta_T - \phi_T)} + |P|e^{i(\delta_P - \phi_P)} \quad \bar{A} = |T|e^{i(\delta_T + \phi_T)} + |P|e^{i(\delta_P + \phi_P)}$$

$$A_{CP} = \frac{|\bar{A}|^2 - |A|^2}{|\bar{A}|^2 + |A|^2} = \frac{2|T||P|\sin(\delta_T - \delta_P)\sin(\phi_T - \phi_P)}{|T|^2 + |P|^2 + 2|T||P|\cos(\delta_T - \delta_P)\cos(\phi_T - \phi_P)}$$

Example:  $B \rightarrow K\pi$

(weak phase difference is  $\gamma$ )

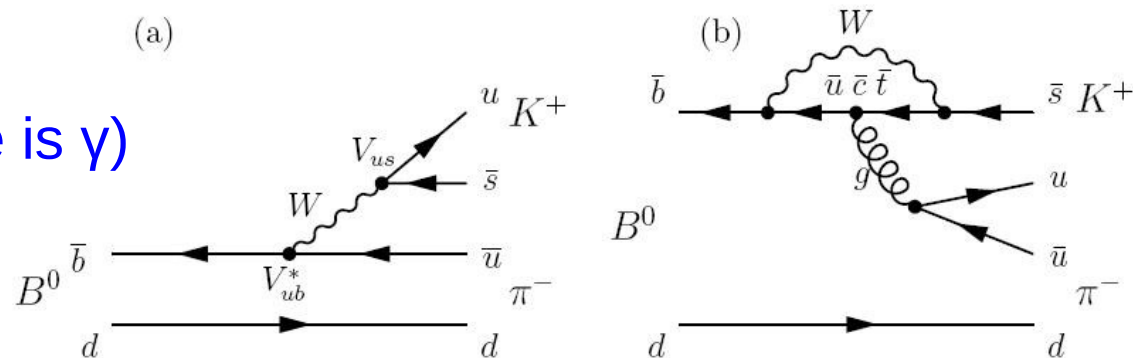

Feynman tree (a) and penguin (b) diagrams for the  $B_d^0 \rightarrow K^+ \pi^-$  decay

# Direct CP violation in $B \rightarrow K\pi$

- Direct CP violation in  $B \rightarrow K\pi$  sensitive to  $\gamma$   
too many hadronic parameters  $\Rightarrow$  need theory input
- NB. interesting deviation from naïve expectation

“ $K\pi$  puzzle”

$$A_{\text{CP}}(K^-\pi^+) = -0.082 \pm 0.006$$

$$A_{\text{CP}}(K^-\pi^0) = +0.040 \pm 0.021$$

HFAG averages

Could be a sign of new physics ...  
... but first need to rule out possibility of  
larger than expected QCD corrections

Belle Nature 452 (2008) 332

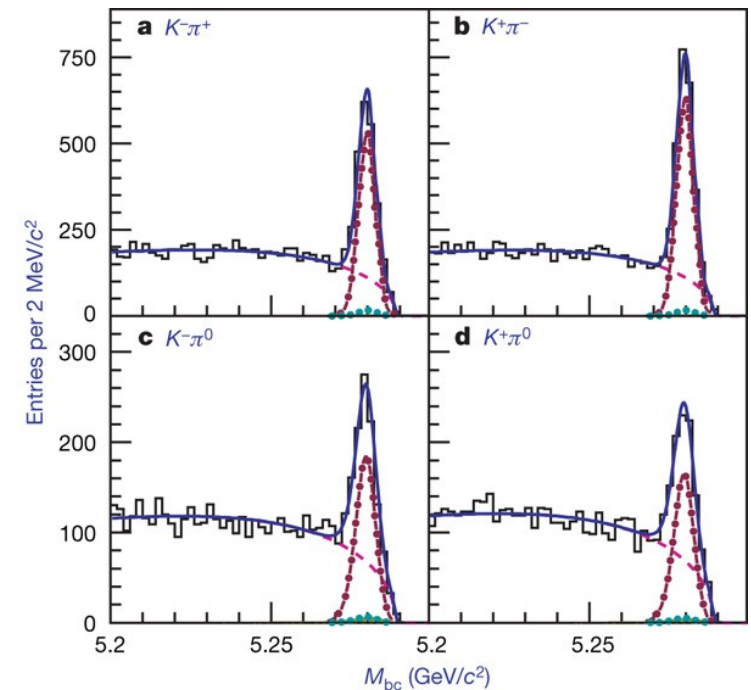

# How to rule out large QCD corrections?

- Measure more  $B_{u,d} \rightarrow K\pi$  decays & relate by isospin
- Perform similar analysis on  $B \rightarrow K^*\pi$  &/or  $B \rightarrow K\rho$
- Measure  $B_s \rightarrow KK$  decays & relate by U-spin

PRL 110 (2013) 221601

$$A_{CP}(B_s^0 \rightarrow K^- \pi^+) = 0.27 \pm 0.04 \text{ (stat)} \pm 0.01 \text{ (syst)}.$$

consistent with SM expectation

5 $\sigma$  observation of CP violation  
in  $B_s \rightarrow K\pi$  decays

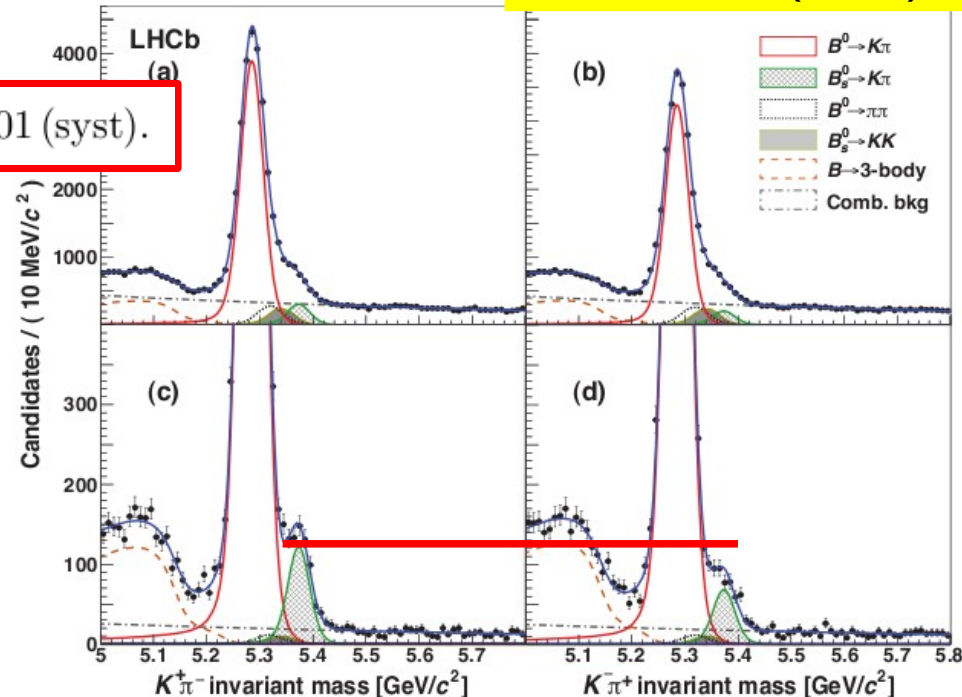



# Surprisingly large *direct* CP violation effects

In regions of phase space of  $B^+ \rightarrow 3h$  decays

PRL 111 (2013) 101801

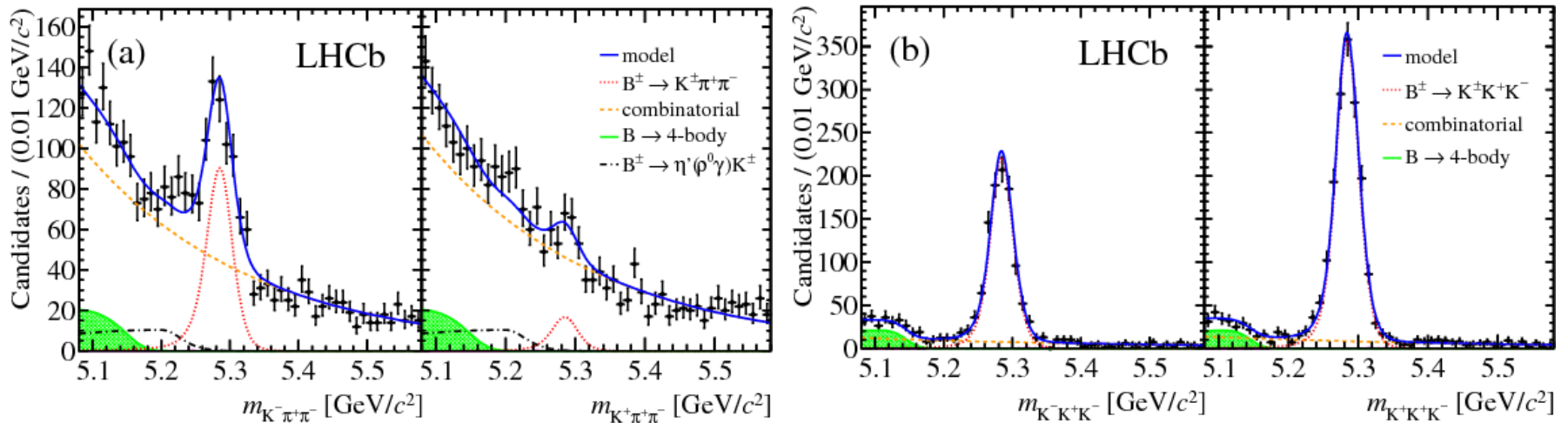

arXiv:1310.4740

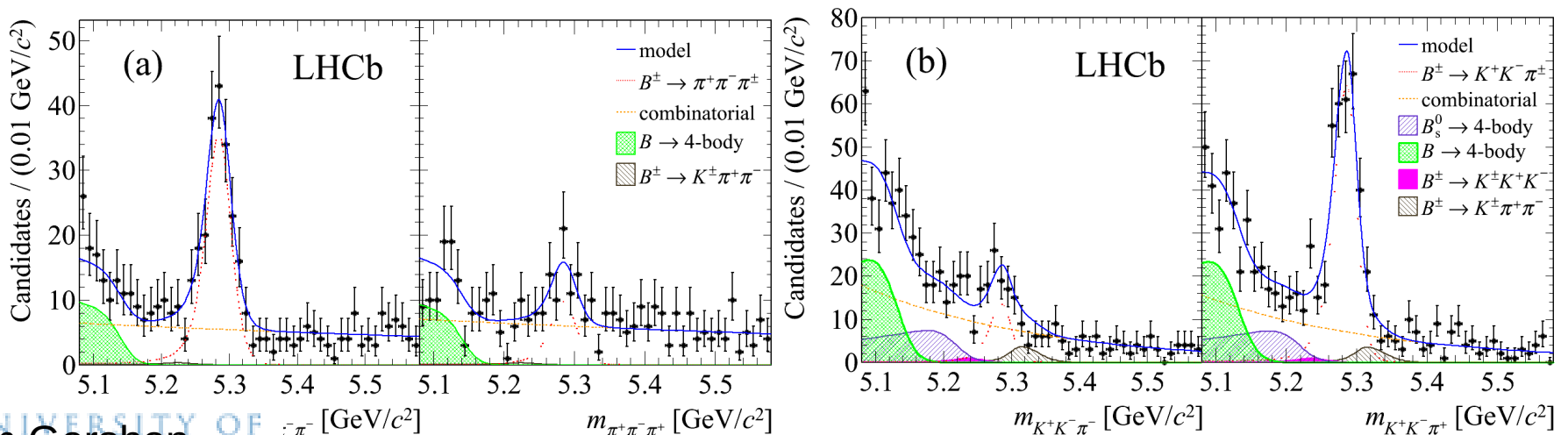

# Importance of $\gamma$ from $B \rightarrow DK$

- $\gamma$  plays a unique role in flavour physics

the only CP violating parameter that can be measured through tree decays only (\*)

(\*) more-or-less

- A benchmark Standard Model reference point
  - doubly important after New Physics is observed

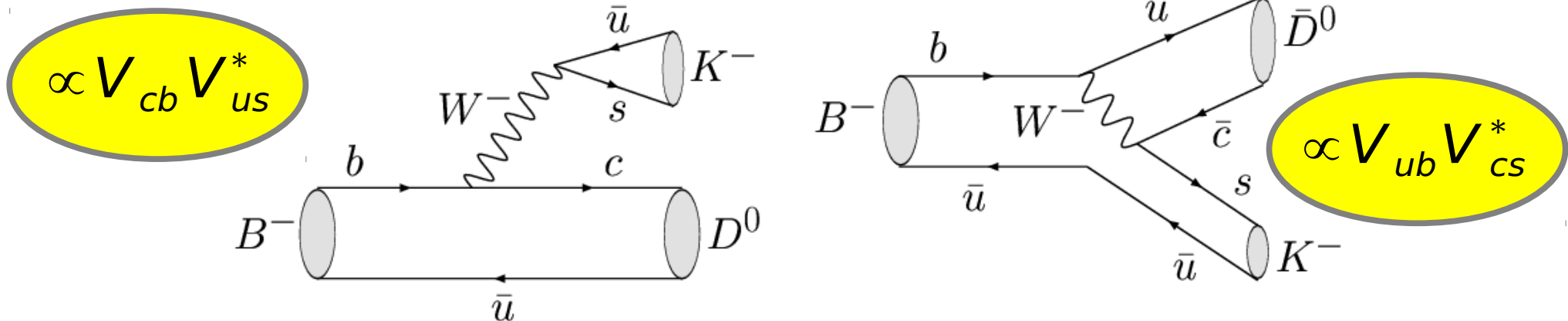

Variants use different B or D decays  
require a final state common to both  $D^0$  and  $\bar{D}^0$

# B → DK decays

## “GLW” and “ADS” methods

PLB 712 (2012) 203

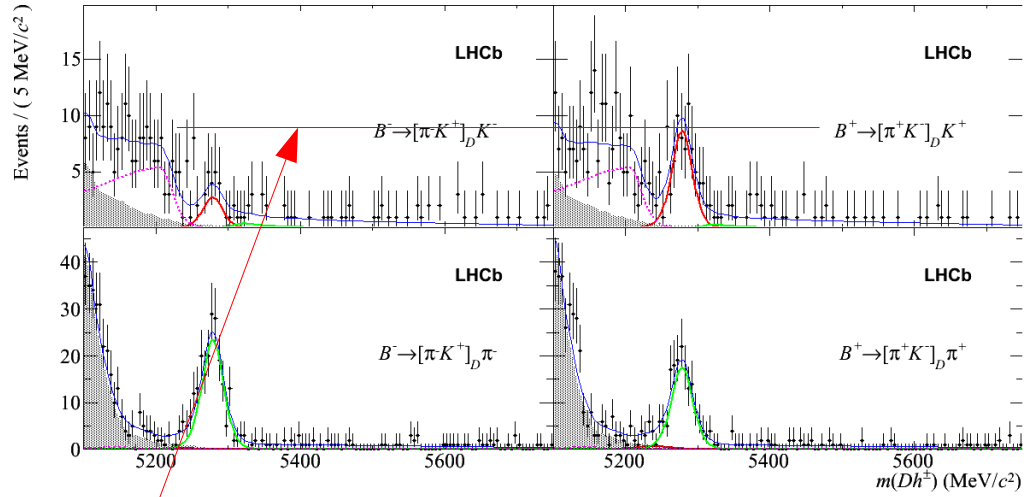
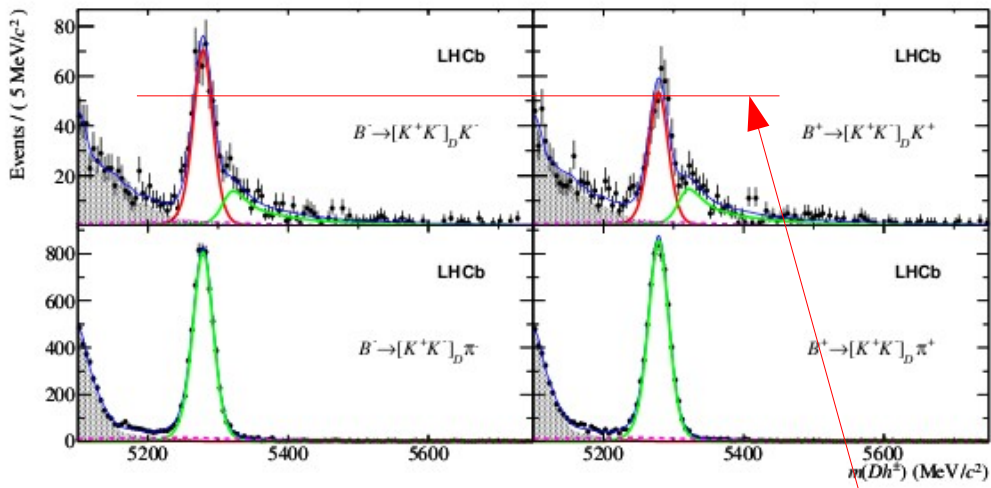

$D_{CP} K A_{CP+}$  **HFAG**  
Moriond 2012 PRELIMINARY

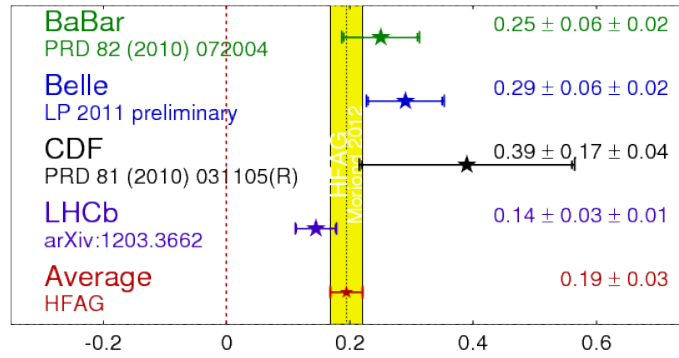

$D_K \pi K R_{ADS}$  **HFAG**  
Moriond 2012 PRELIMINARY

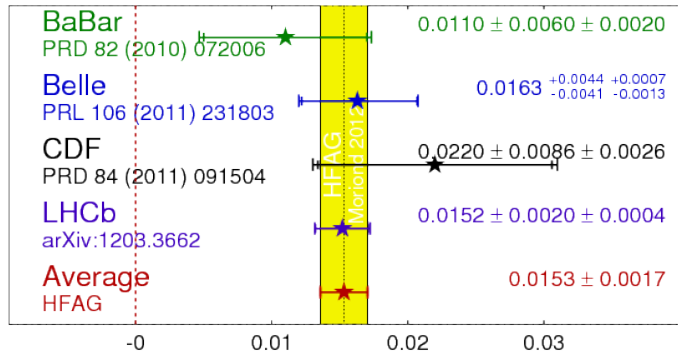

Observation of CP violation in B → DK decays

# $\gamma$ from combination of $B^+ \rightarrow DK^+$ modes

BaBar PRD 87 (2013) 052015  
Belle CKM2012 preliminary  
PLB 726 (2013) 151  
& LHCb-CONF-2013-006

- All direct CP violation effects caused by  $\gamma$  in the Standard Model
- Only those in  $B \rightarrow DK$  type processes involve only tree-level diagrams
  - enable determination of  $\gamma$  with negligible theoretical uncertainty
- Several different B and D decays can be used
- Combination includes results from GLW/ADS ( $D \rightarrow hh$ ) & GGSZ ( $D \rightarrow K_s hh$ )
- Sensitivity: BaBar & Belle each  $\sim 16^\circ$ ; latest LHCb  $\sim 12^\circ$

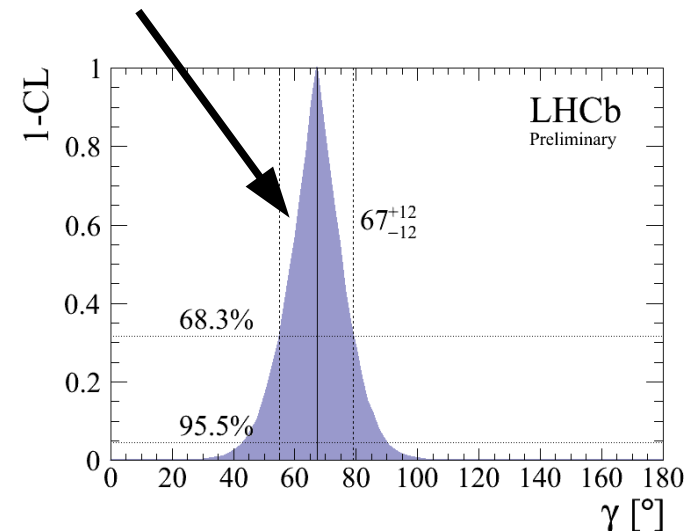
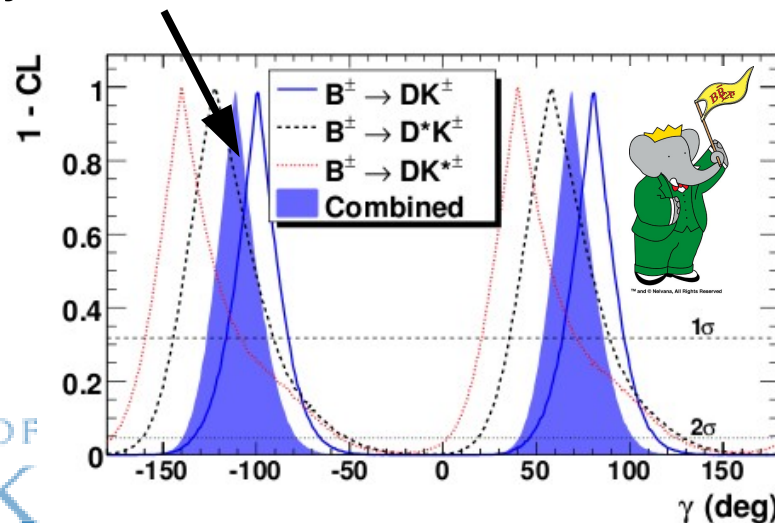

# CP violation in neutral meson mixing

# Neutral meson mixing – oscillation phenomena over 4 orders in magnitude

PRL 110 (2013) 101802

NJP 15 (2013) 053021

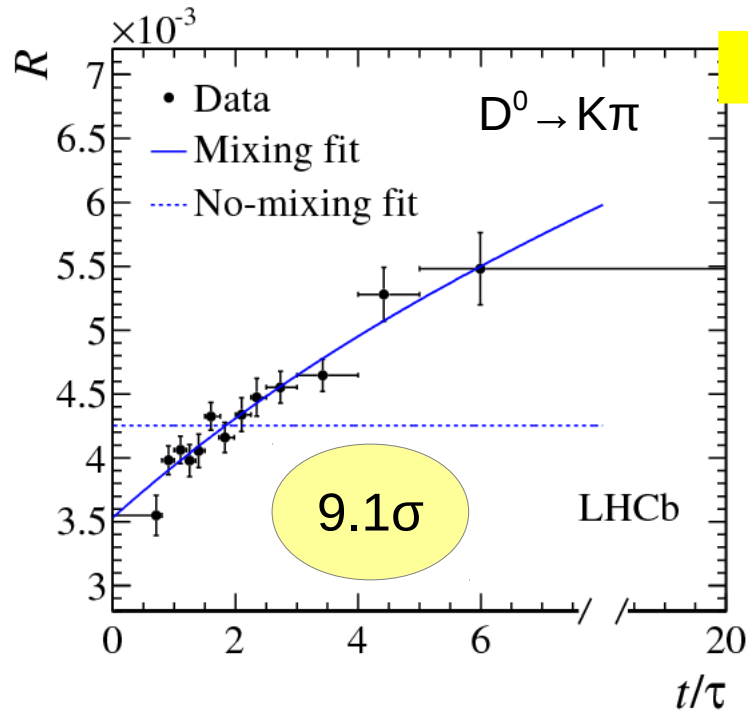

Fit type ( $\chi^2/\text{ndf}$ )	Parameter	Fit result ( $10^{-3}$ )	Correlation coefficient		
			$R_D$	$y'$	$x'^2$
Mixing (9.5/10)	$R_D$	$3.52 \pm 0.15$	1	-0.954	+0.882
	$y'$	$7.2 \pm 2.4$		1	-0.973
	$x'^2$	$-0.09 \pm 0.13$			1
No mixing (98.1/12)	$R_D$	$4.25 \pm 0.04$			

PLB 719 (2013) 318

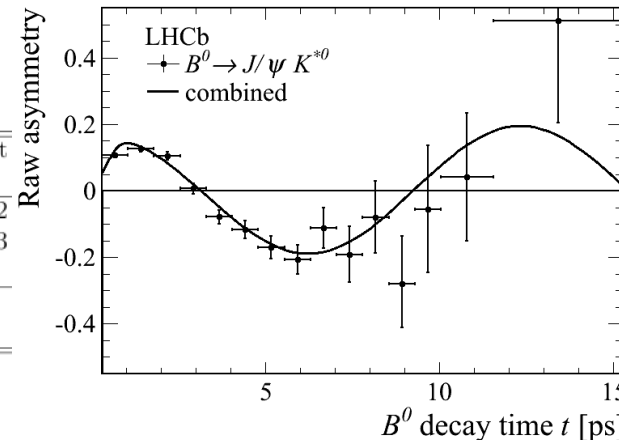
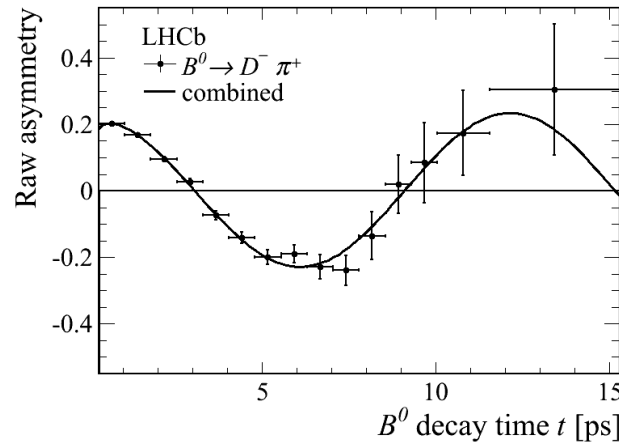

$B_s^0 \rightarrow D_s \pi$

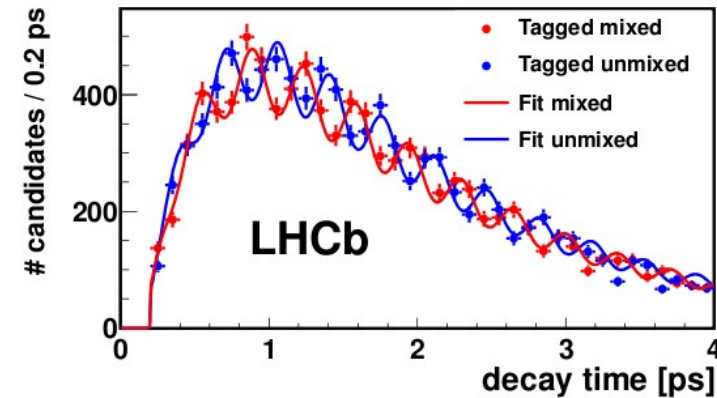

$\Delta m_s = (17.768 \pm 0.023 \text{ (stat)} \pm 0.006 \text{ (syst)}) \text{ ps}^{-1}$   
 O(%) precision & still statistically limited

# Is there CP violation in B *mixing*?

Semileptonic asymmetries in both  $B_d$  and  $B_s$  systems negligibly small in the SM

Results of inclusive dimuon asymmetry analysis  $3.6\sigma$  from SM

D0 arXiv:1310.0447,  
PRL 110 (2013) 011801,  
PRD 86 (2012) 072009

Constraint in  $a_{sl}^d - a_{sl}^s$  plane obtained from oscillated  $B_d$  or  $B_s$  enriched samples (cutting on impact parameter)

Including results on  $a_{sl}^d$  and  $a_{sl}^s$  individually (from  $D^{(*)+}\mu^- \nu X$  and  $D_s^+ \mu^- \nu X$  samples) puts combination at  $3.1\sigma$  from SM

Results on  $a_{sl}^d$  and  $a_{sl}^s$  from B factories and LHCb consistent with SM but not inconsistent with D0

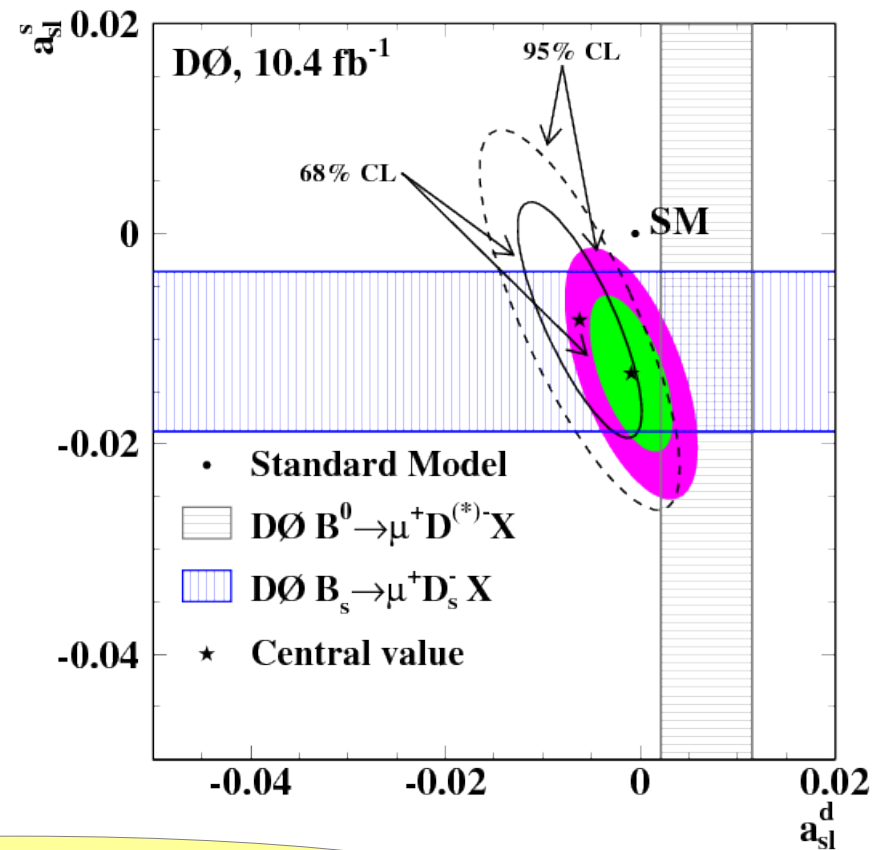

Situation unclear – improved measurements needed

# CP violation in mixing-decay interference

When both particle and anti-particle can decay to the same final state, the oscillations act as an interferometer to measure the relative phase

Used very productively for  $B^0 \rightarrow J/\psi K_S$  decays to measure  $\sin(2\beta)$  at BaBar & Belle

Exploit the same idea to measure the  $B_s^0$  oscillation phase ( $\phi_s$ ), which is very small in the Standard Model  $\rightarrow$  provides a null test

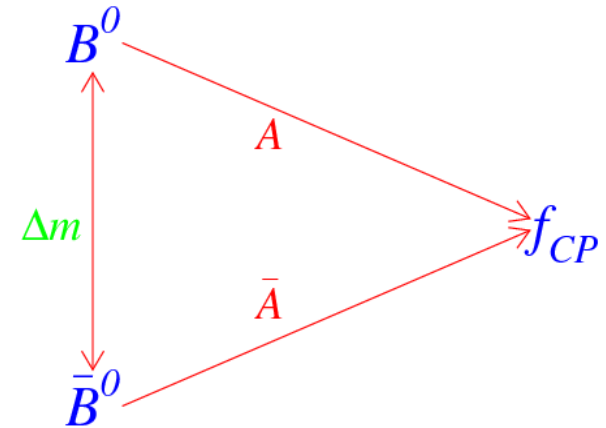

## BABAR

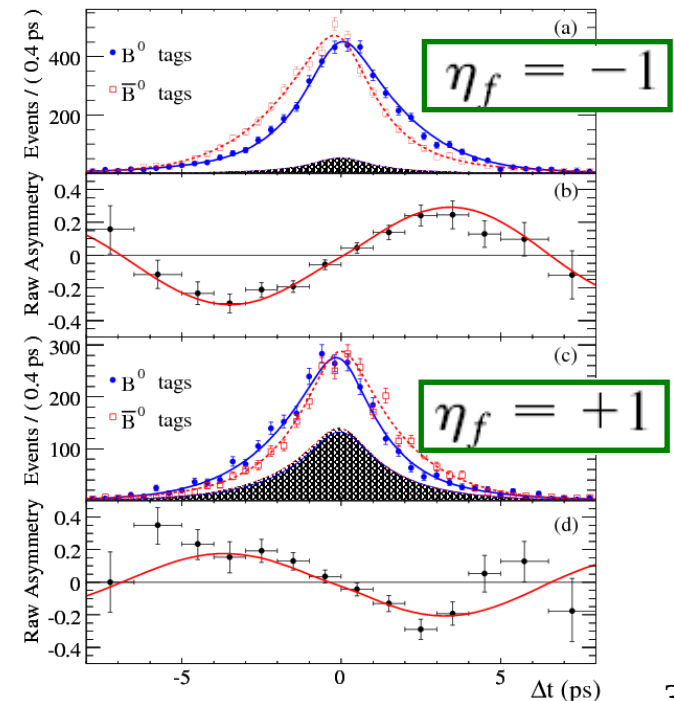



$$\Phi_s = -2\beta_s (B_s \rightarrow J/\psi\phi)$$

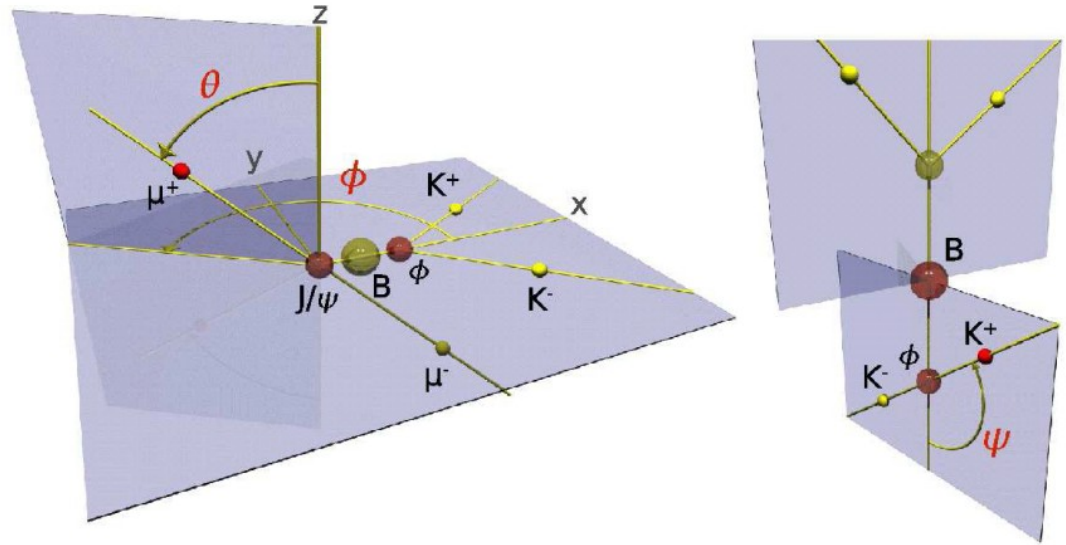

- VV final state

three helicity amplitudes

→ mixture of CP-even and CP-odd

disentangled using angular & time-dependent distributions

→ additional sensitivity

many correlated variables

→ complicated analysis

- LHCb also uses  $B_s \rightarrow J/\psi f_0$  ( $f_0 \rightarrow \pi^+\pi^-$ )

- CP eigenstate; simpler analysis

- fewer events; requires input from  $J/\psi\phi$  analysis ( $\Gamma_s, \Delta\Gamma_s$ )

# Improved measurements of $B_s$ oscillations and CP violation

LHCb PRD 87 (2013) 112010

$B_s \rightarrow J/\psi KK$  (&  $J/\psi \pi\pi$ )

LHCb PRL 110 (2013) 241802

$B_s \rightarrow \phi\phi$

Start to compare tree-level decays with much rarer penguin processes  $\rightarrow$  sensitive test with higher statistics

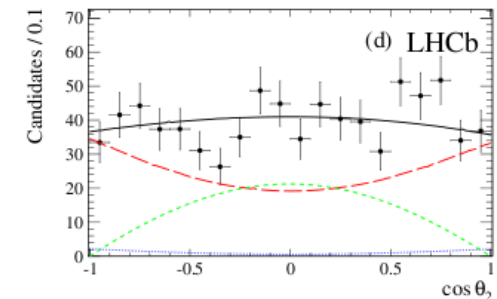
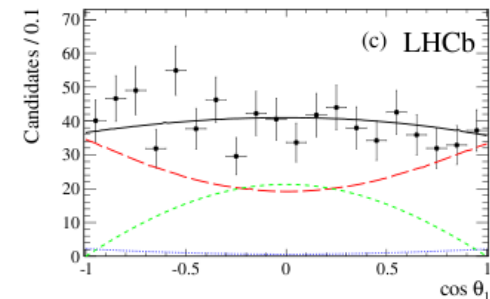
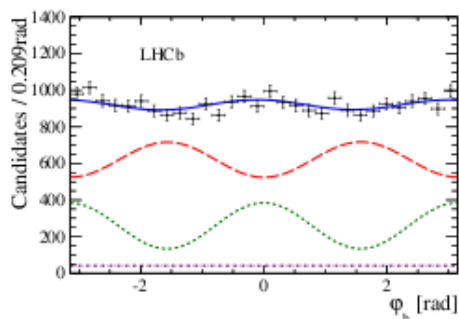
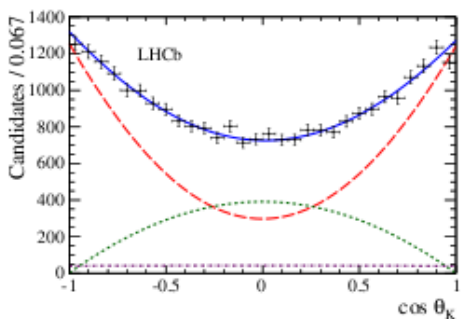
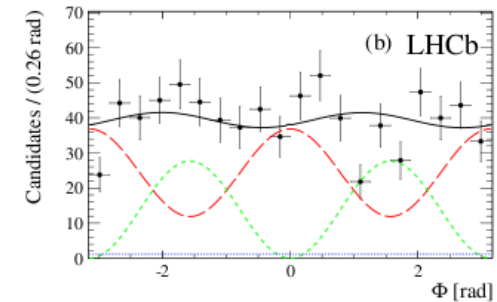
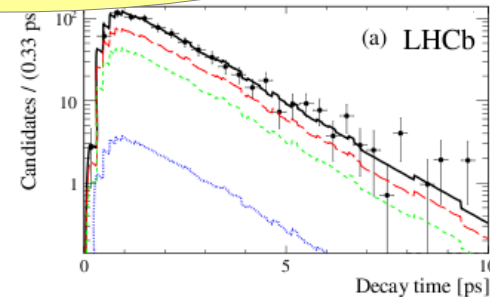
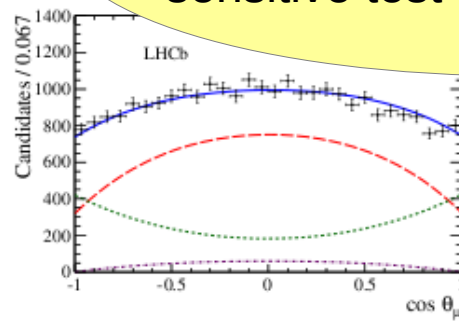
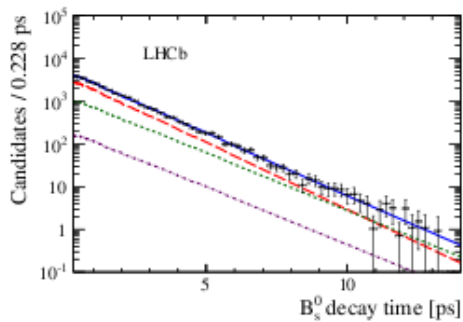

$$\phi_s = 0.01 \pm 0.07 \text{ (stat)} \pm 0.01 \text{ (syst) rad,}$$

$$\Gamma_s = 0.661 \pm 0.004 \text{ (stat)} \pm 0.006 \text{ (syst) ps}^{-1},$$

$$\Delta\Gamma_s = 0.106 \pm 0.011 \text{ (stat)} \pm 0.007 \text{ (syst) ps}^{-1}.$$

# Improved measurements of $B_s$ lifetimes and CP violation

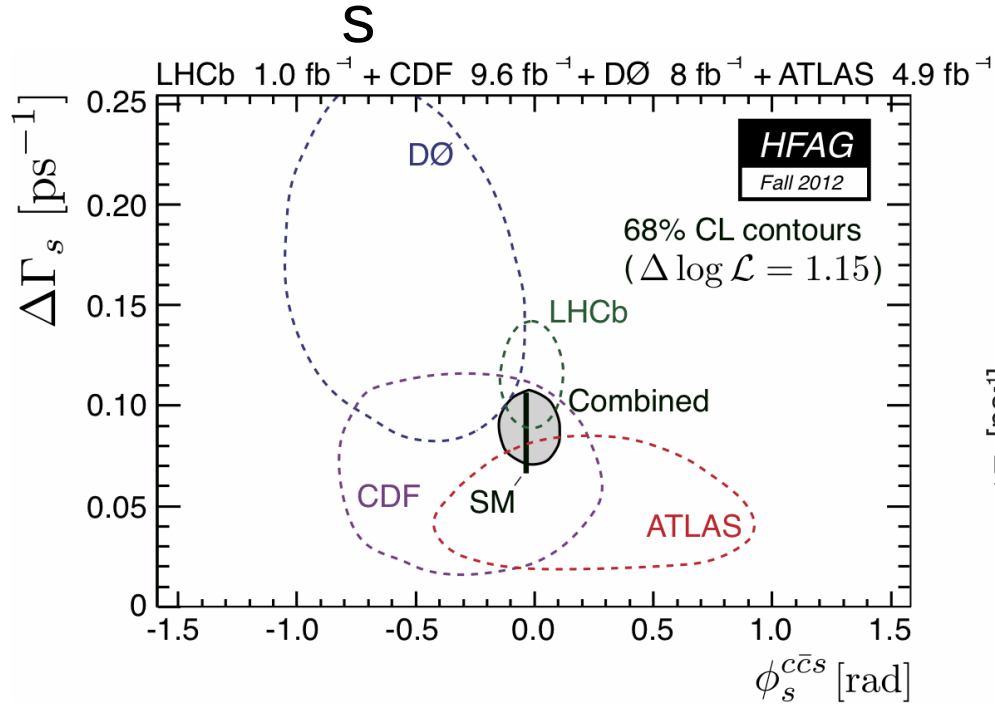

LHCb PRD 87 (2013) 112010  
 CDF PRD 85 (2012) 072002  
 D0 PRD 85 (2012) 032006  
 ATLAS JHEP 12 (2012) 072 &  
 ATLAS-CONF-2013-039

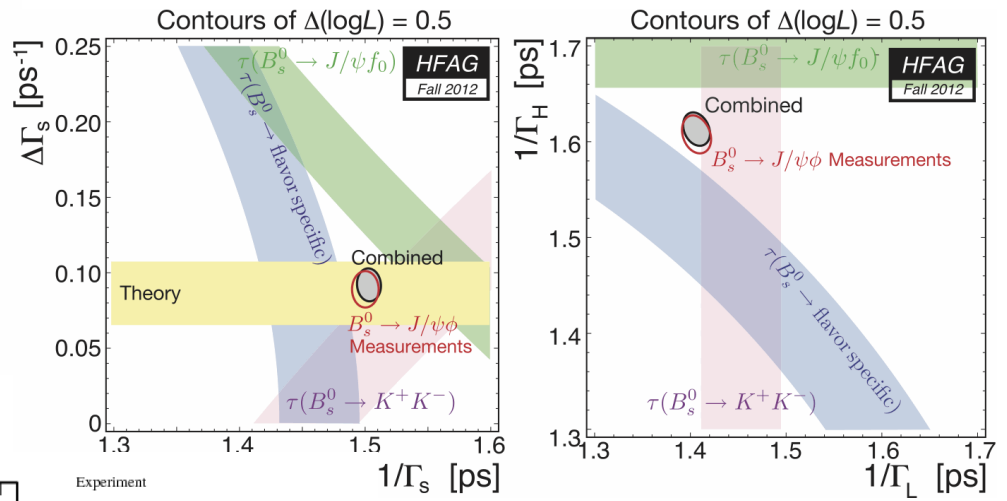

N.B. Improved  $\Lambda_b$  lifetime measurements of great interest:

- D0 PRD 85 (2012) 112003
- ATLAS PRD 87 (2013) 032002
- CMS JHEP 07 (2013) 163
- LHCb PRL 111 (2013) 102003

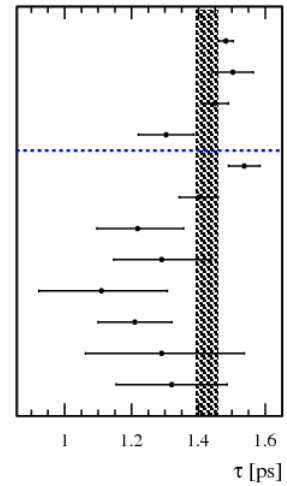

- Experiment
- LHCb (2013) [ $J/\psi p K$ ]
  - CMS (2012) [ $J/\psi \Lambda$ ]
  - ATLAS (2012) [ $J/\psi \Lambda$ ]
  - D0 (2012) [ $J/\psi \Lambda$ ]
  - CDF (2011) [ $J/\psi \Lambda$ ]
  - CDF (2010) [ $\Lambda_c^+ \pi$ ]
  - D0 (2007) [ $J/\psi \Lambda$ ]
  - D0 (2007) [Semileptonic decay]
  - DLPH (1999) [Semileptonic decay]
  - ALEP (1998) [Semileptonic decay]
  - OPAL (1998) [Semileptonic decay]
  - CDF (1996) [Semileptonic decay]

... tensions with expectations reduced

# Is there CP violation in the charm system? (and if so, where does it come from?)

To reduce systematics and (perhaps) enhance CP violation effect, experiments measure

LHCb PLB 723 (2013) 33,  
LHCb-CONF-2013-003  
CDF PRL 109 (2012) 111801  
Belle ICHEP preliminary

$$\Delta A_{CP} \equiv A_{CP}(K^- K^+) - A_{CP}(\pi^- \pi^+) \\ = [a_{CP}^{\text{dir}}(K^- K^+) - a_{CP}^{\text{dir}}(\pi^- \pi^+)] + \frac{\Delta \langle t \rangle}{\tau} a_{CP}^{\text{ind}}$$

$\Delta A_{CP}$  related mainly to direct CP violation  
(contribution from indirect CPV suppressed by difference in mean decay time)

$$\Delta a_{CP}^{\text{dir}} = (-0.33 \pm 0.12)\%$$

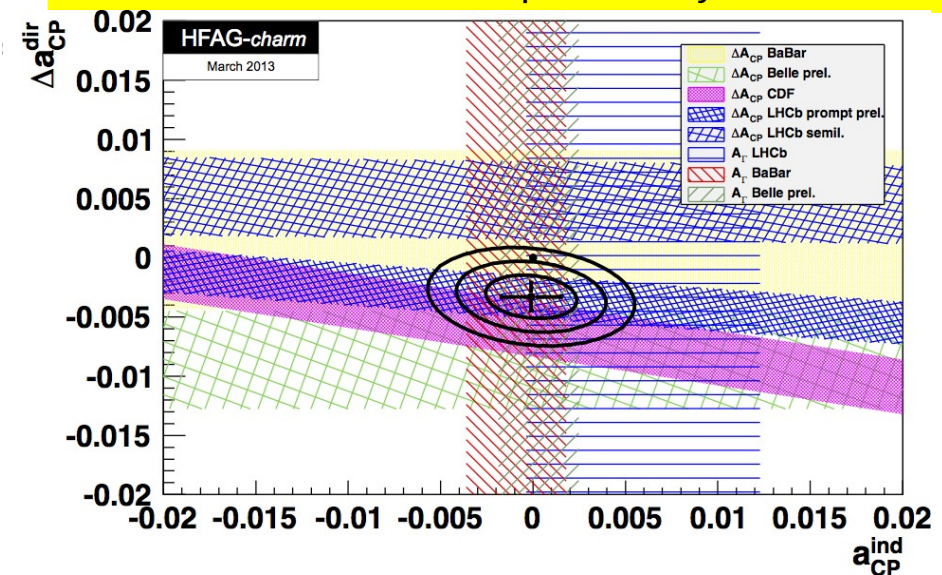

Previous evidence for CPV  
not confirmed  
Need more precise measurements

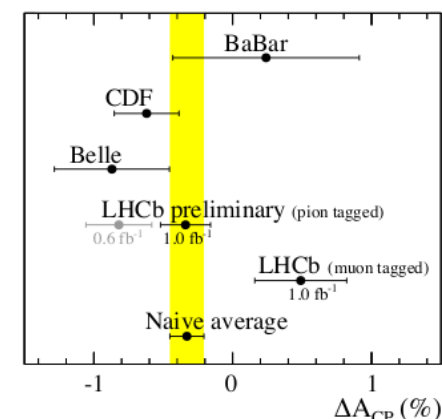
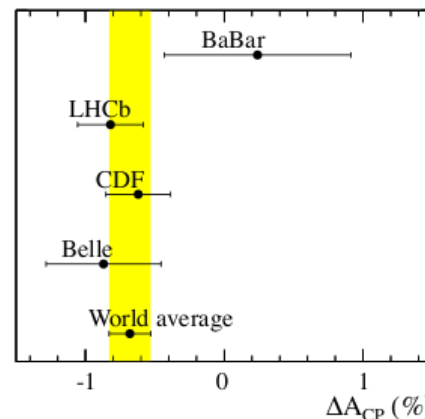

# Selected highlights of results

## Rare Decays

$$B_s \rightarrow \mu^+ \mu^-$$

## Killer app. for new physics discovery

Very rare in Standard Model due to

- absence of tree-level FCNC
  - helicity suppression
  - CKM suppression
- ... all features which are not necessarily reproduced in extended models

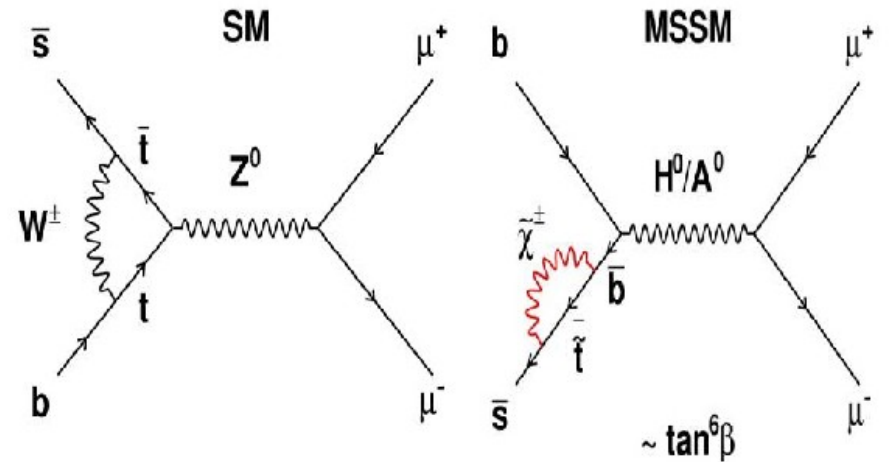

$$B(B_s \rightarrow \mu^+ \mu^-)^{SM} = (3.2 \pm 0.3) \times 10^{-9}$$

$$B(B_s \rightarrow \mu^+ \mu^-)^{MSSM} \sim \tan^6 \beta / M_{A^0}^4$$

Buras et al, EPJ C72 (2012) 2172

N.B. Should be corrected up by 9% since measurement is of the time-integrated branching fraction (PRL 109 (2012) 041801)

# $B_{(s)}^0 \rightarrow \mu^+ \mu^-$ – analysis ingredients

- Produce a very large sample of B mesons
- Trigger efficiently on dimuon signatures
- Reject background
  - excellent vertex resolution (identify displaced vertex)
  - excellent mass resolution (identify B peak)
    - also essential to resolve  $B^0$  from  $B_s^0$  decays
  - powerful muon identification (reject background from B decays with misidentified pions)
  - typical to combine various discriminating variables into a multivariate classifier
    - e.g. Boosted Decision Trees algorithm

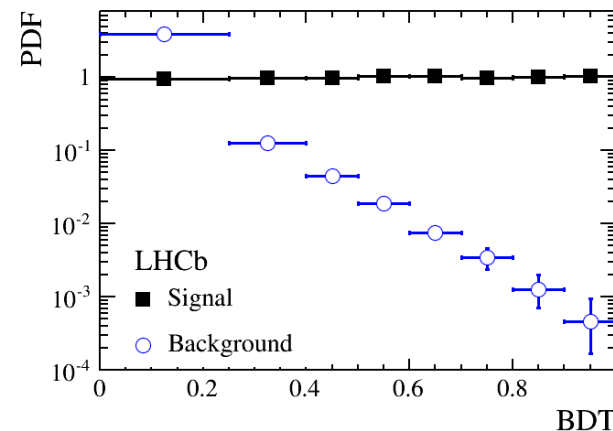

$$B_{(s)}^0 \rightarrow \mu^+ \mu^-$$

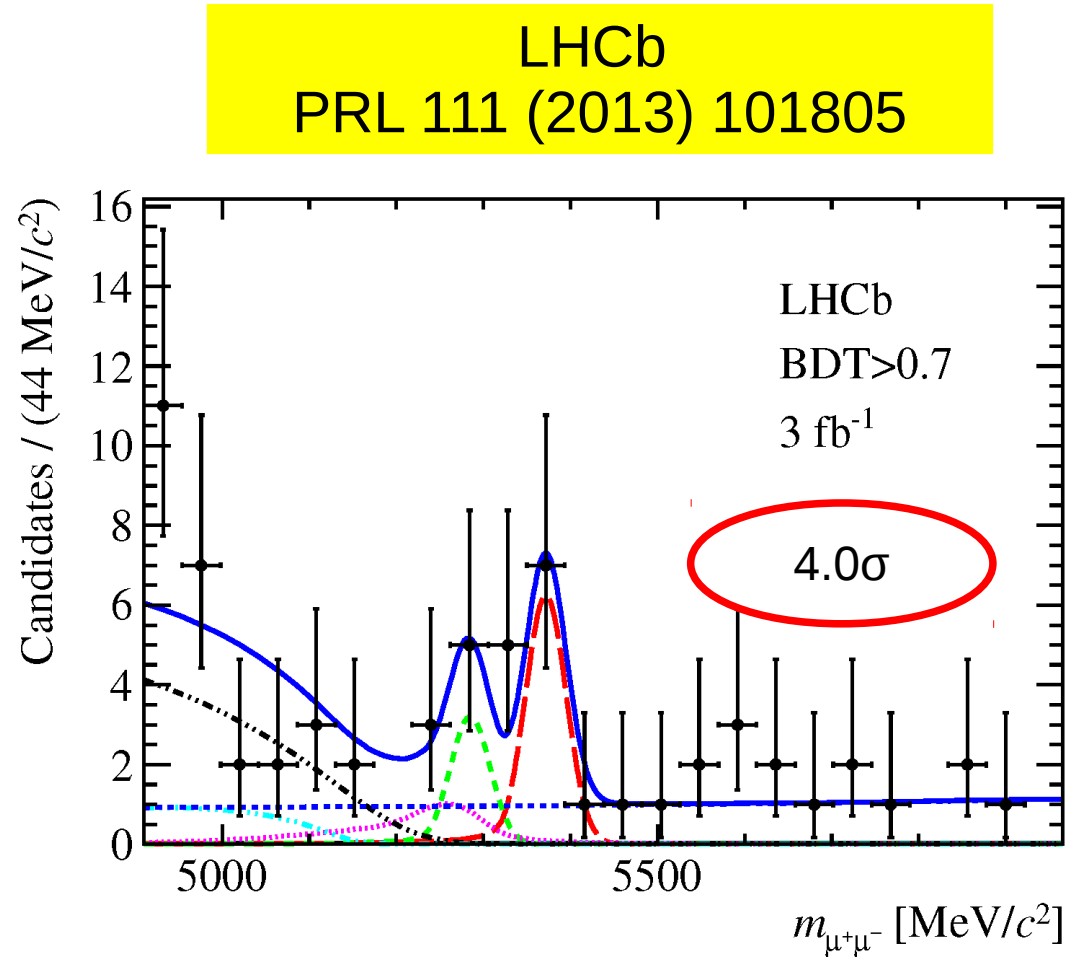
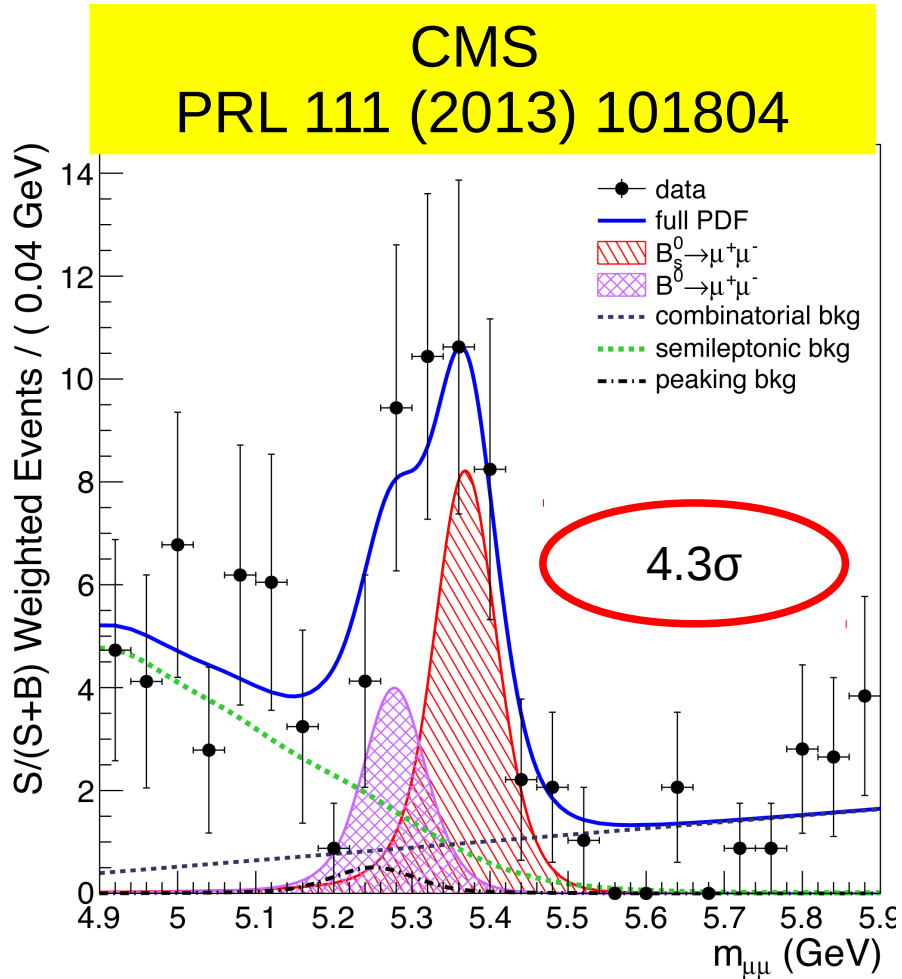



# $B_{(s)}^0 \rightarrow \mu^+ \mu^-$ – combined results

LHCb-CONF-2013-012  
CMS-PAS-BPH-13-007

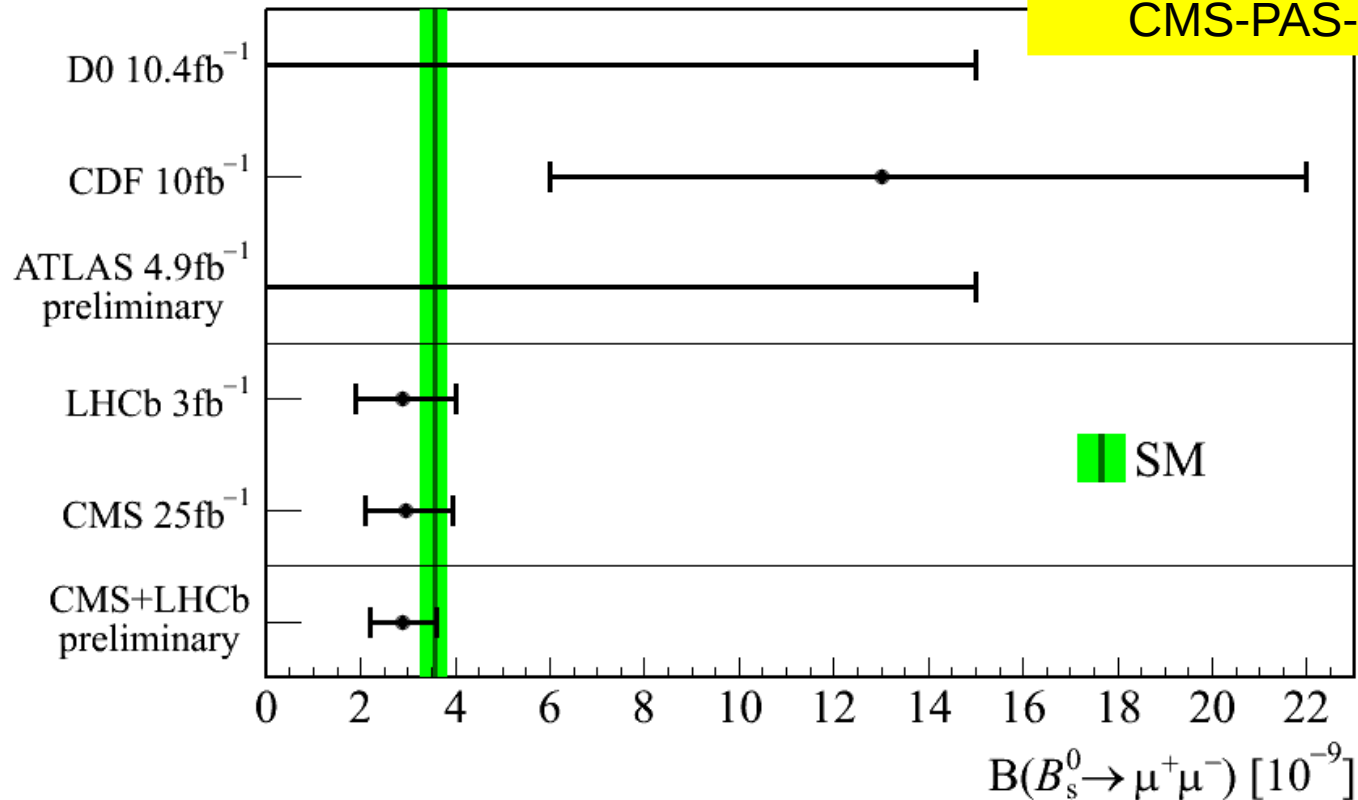

$$B(B_s^0 \rightarrow \mu^+ \mu^-) = (2.9 \pm 0.7) \times 10^{-9}$$

Observed!

$$B_{(s)}^0 \rightarrow \mu^+ \mu^-$$

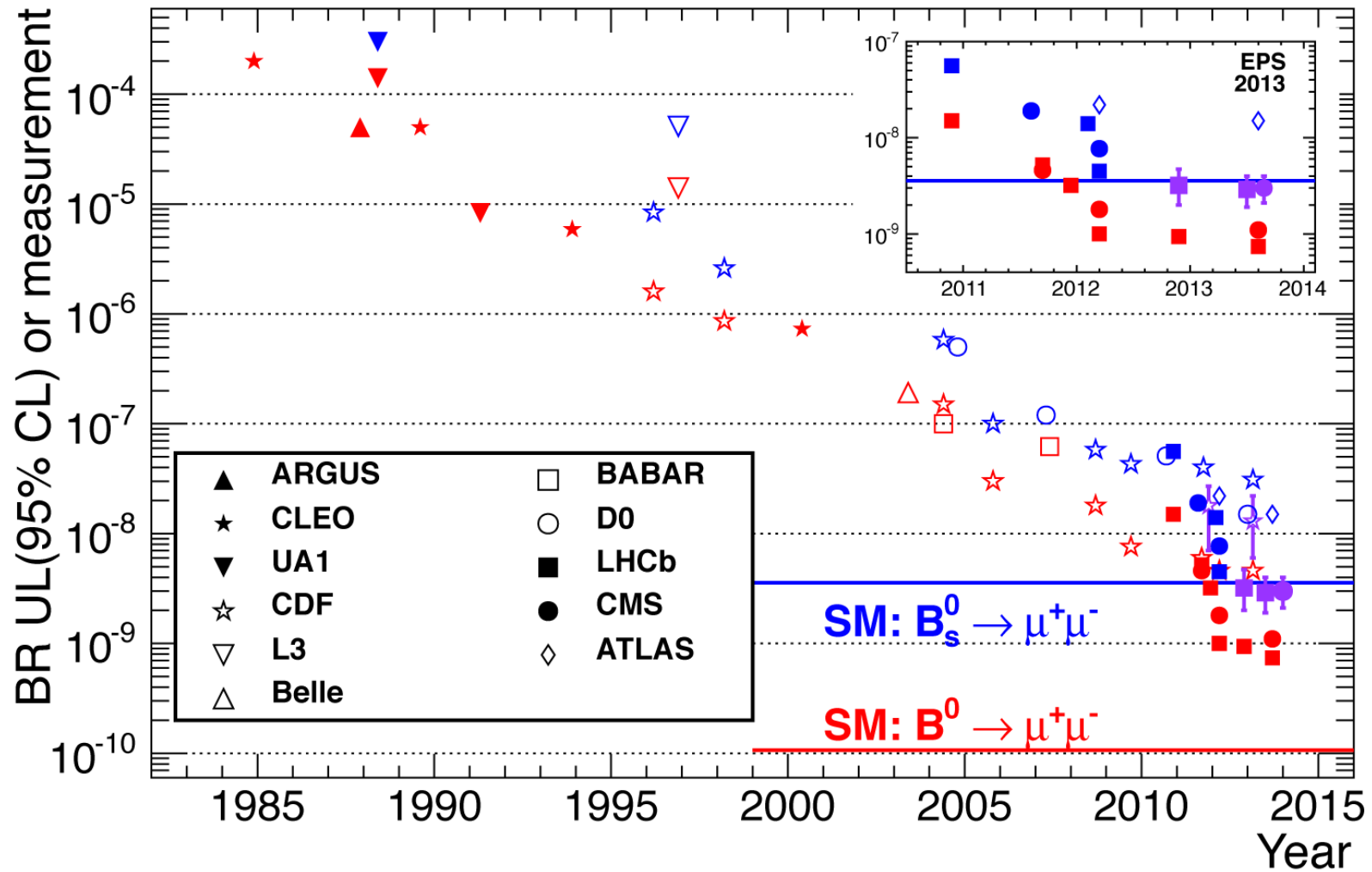

Searches over 30 years

# Impact of $B_s \rightarrow \mu^+ \mu^-$

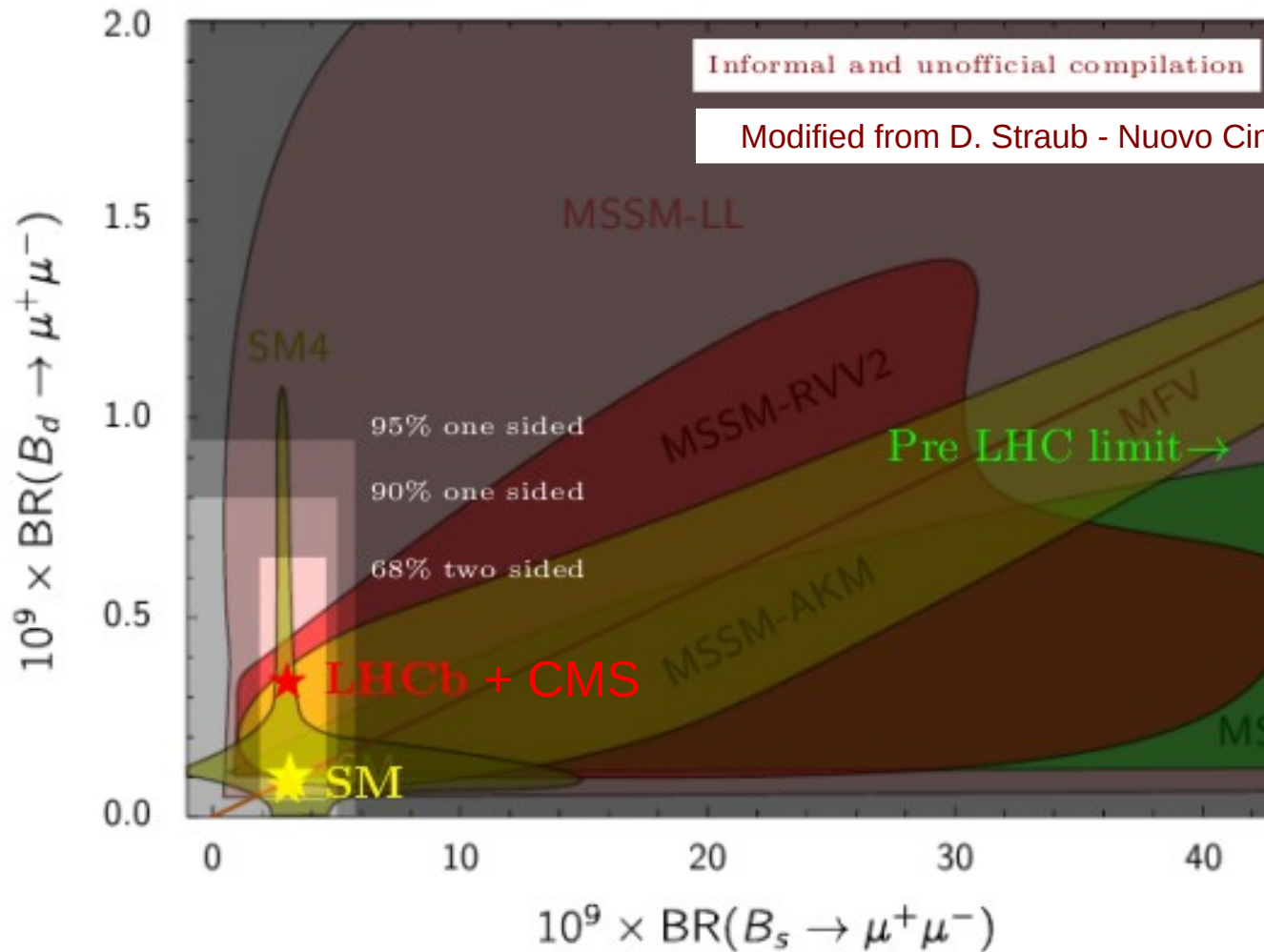

$$B \rightarrow K^* \mu^+ \mu^-$$

- $B_d \rightarrow K^{*0} \mu^+ \mu^-$  provides complementary approach to search for new physics in  $b \rightarrow s l^+ l^-$  FCNC processes
  - rates, angular distributions and asymmetries sensitive to NP
  - superb laboratory for NP tests
  - **experimentally clean signature**
  - many kinematic variables ...
  - ... **with clean theoretical predictions**

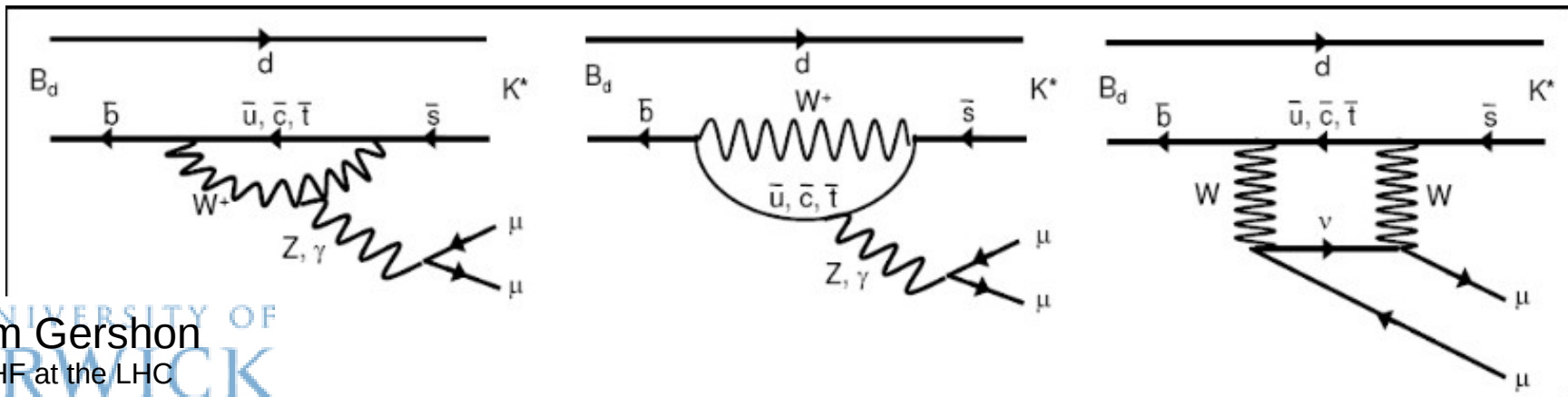

# Angular analysis of $B^0 \rightarrow K^{*0} \mu^+ \mu^-$

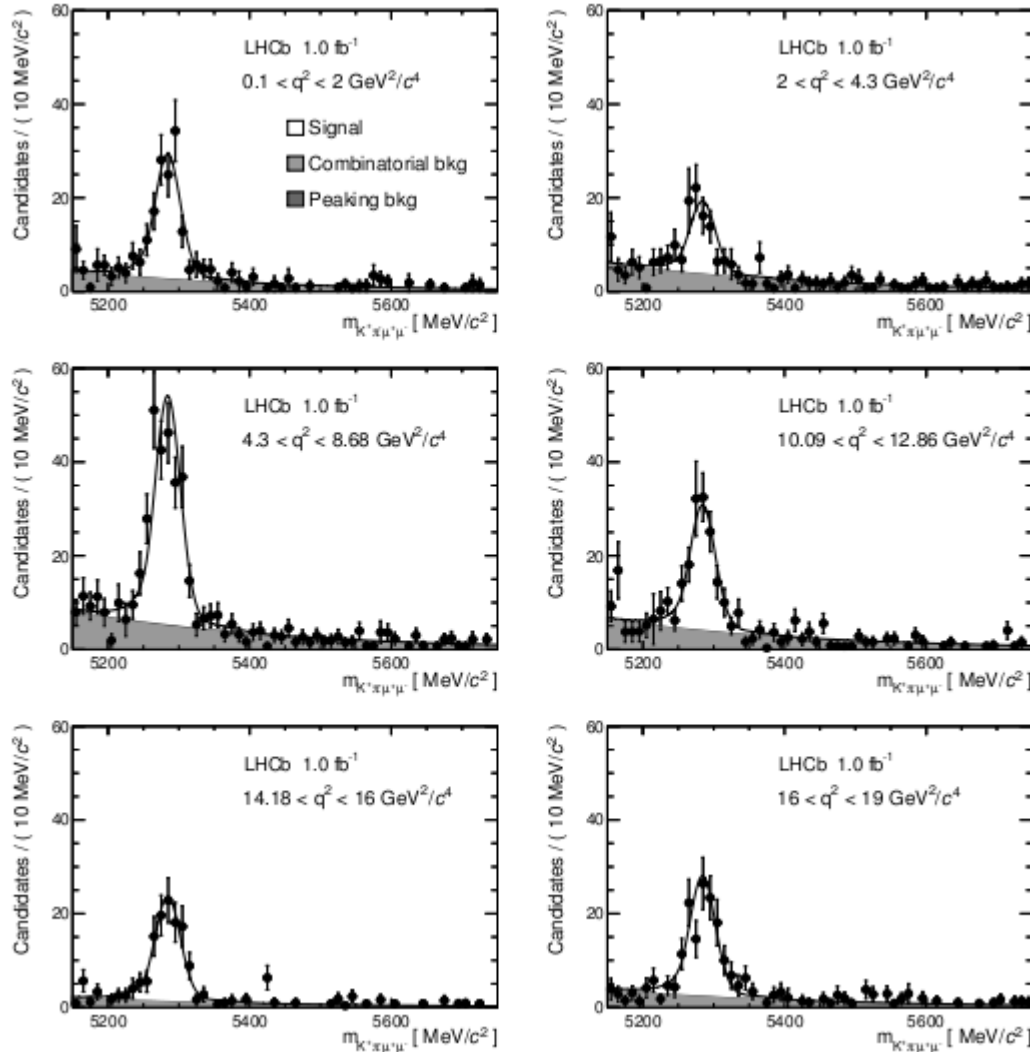

LHCb JHEP 08 (2013) 131  
 See also CDF PRL 108 (2012) 081807  
 BaBar PRD 86 (2012) 032012  
 ATLAS-CONF-2013-038 & CMS BPH-11-009

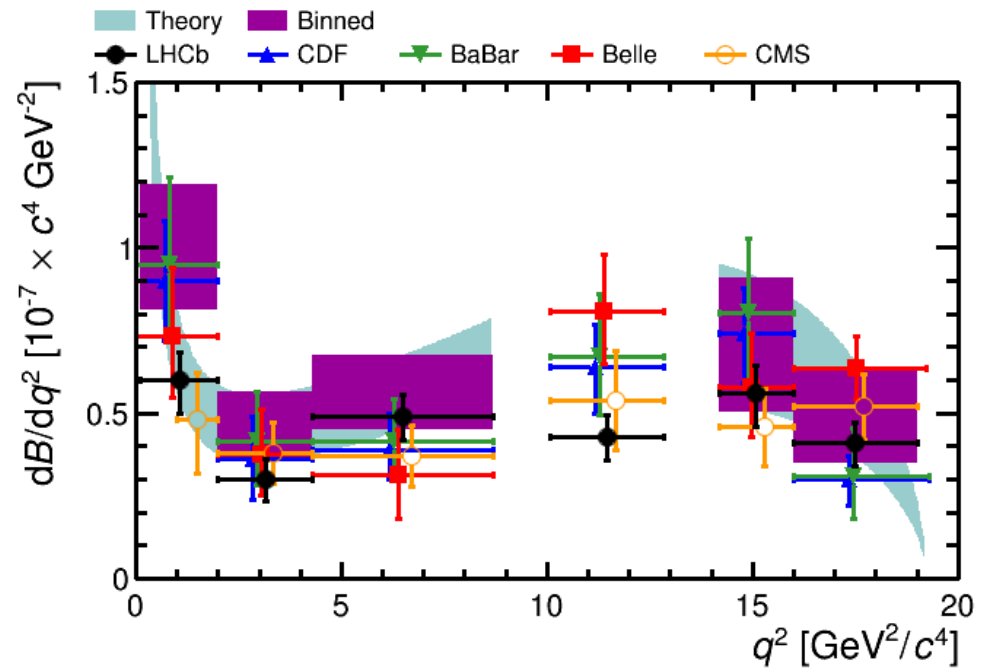

Analysis performed in bins of dimuon invariant mass squared ( $q^2$ )

# Angular analysis of $B^0 \rightarrow K^{*0} \mu^+ \mu^-$

LHCb JHEP 08 (2013) 131  
 See also CDF PRL 108 (2012) 081807  
 BaBar PRD 86 (2012) 032012  
 ATLAS-CONF-2013-038 & CMS BPH-11-009

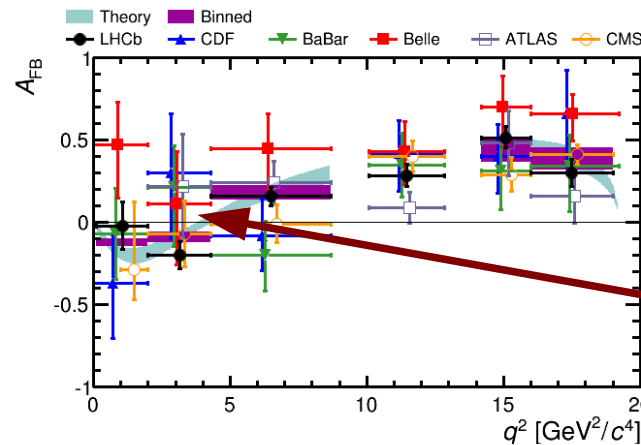
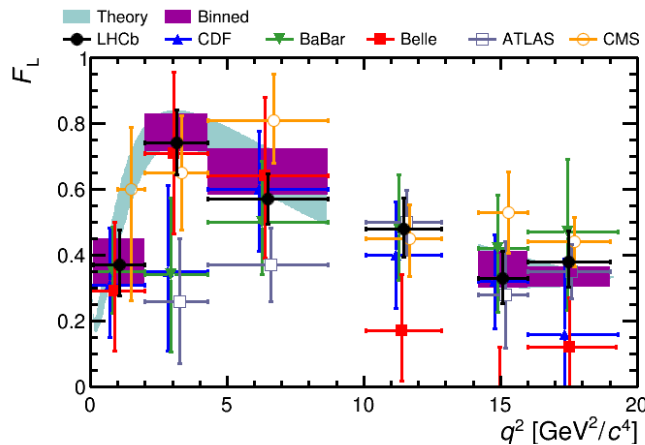

First measurement of zero-crossing point of  $A_{FB}$

$$q_0^2 = (4.9 \pm 0.9) \text{ GeV}^2/c^4$$

Consistent with SM expectation

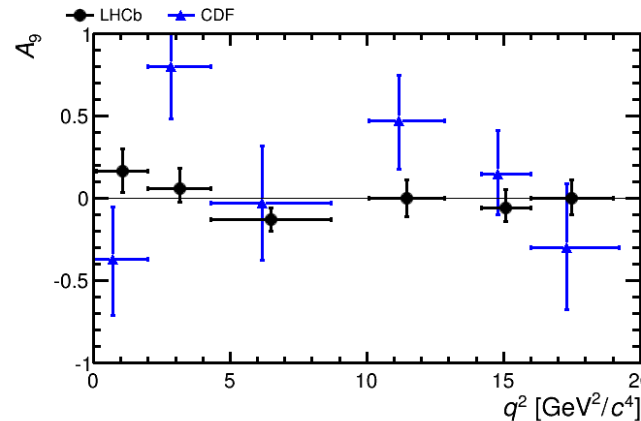
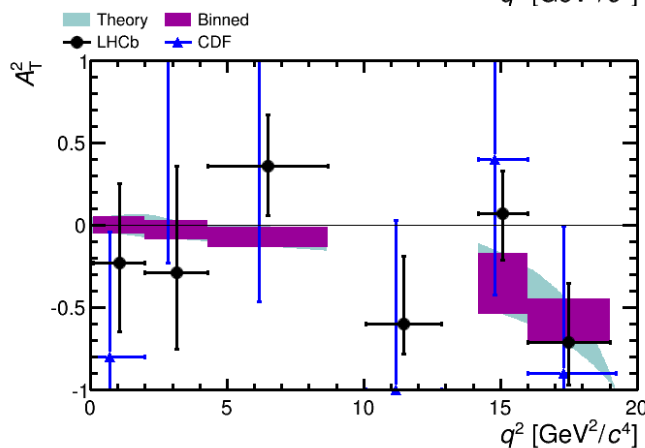

# Isospin asymmetry in $B \rightarrow K^{(*)} \mu \mu$

LHCb JHEP 07 (2012) 133

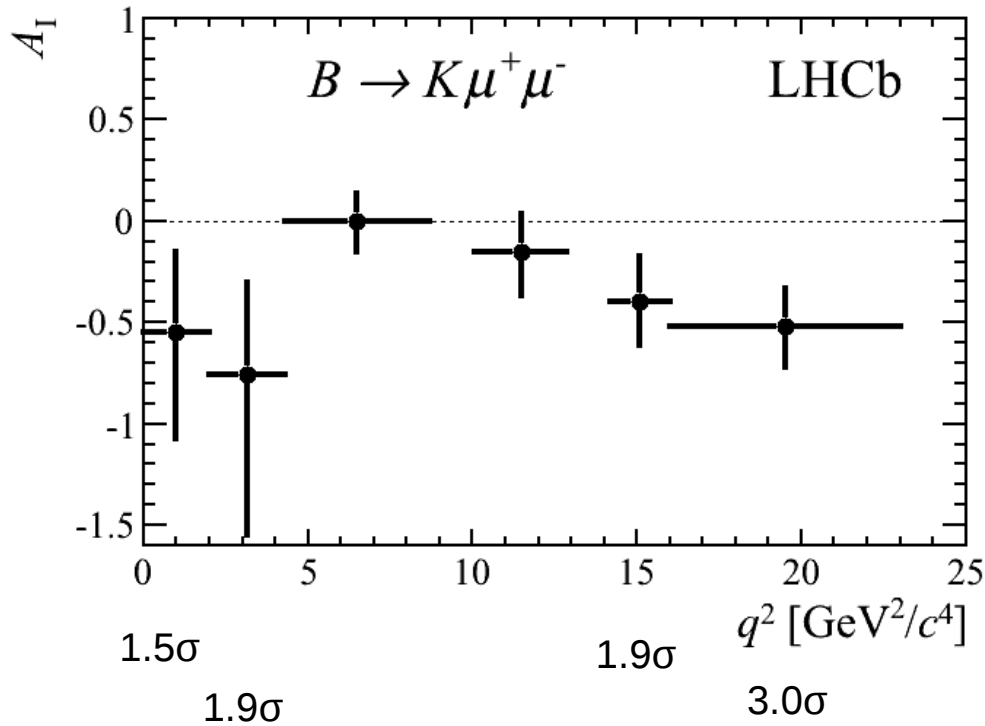

Deviation from zero integrated over  $q^2 \sim 4.4\sigma$   
 Consistent with previous measurements  
 (BaBar, Belle, CDF)

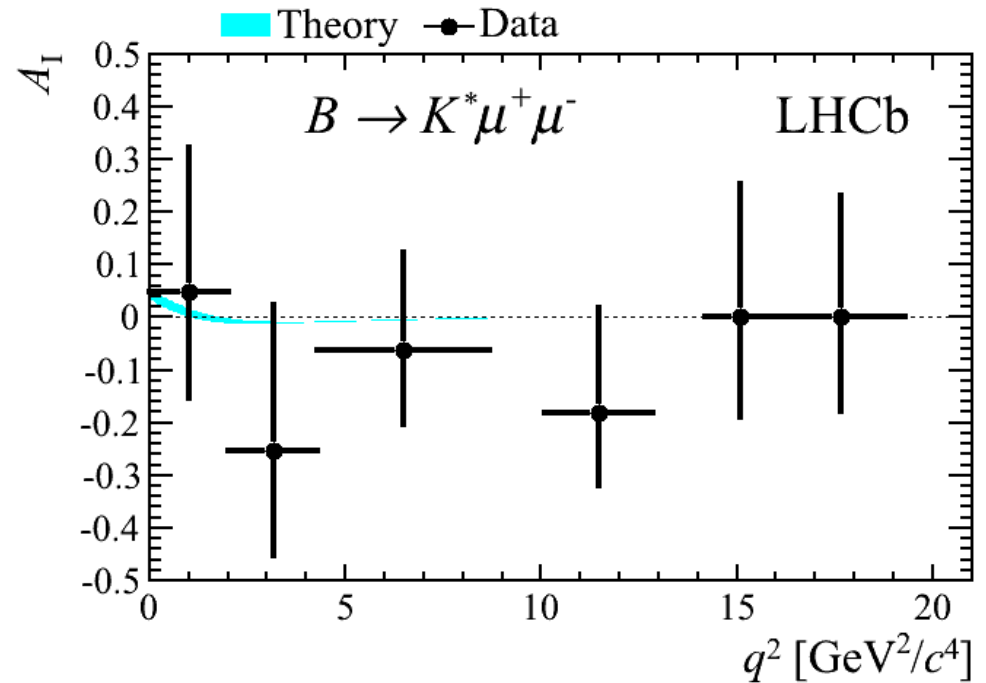

Consistent with zero & with SM prediction  
 Consistent with previous measurements  
 (BaBar, Belle, CDF)

Food for thought ...

# New observables in $B^0 \rightarrow K^{*0} \mu^+ \mu^-$

PRL 111 (2013) 191801

Full angular distribution ( $B^0$  and  $\bar{B}^0$  averaged):

$$\frac{1}{d\Gamma/dq^2 d\cos\theta_\ell d\cos\theta_K d\phi dq^2} \frac{d^4\Gamma}{dq^2} = \frac{9}{32\pi} \left[ \frac{3}{4}(1-F_L)\sin^2\theta_K + F_L\cos^2\theta_K + \frac{1}{4}(1-F_L)\sin^2\theta_K\cos 2\theta_\ell \right. \\ \left. - F_L\cos^2\theta_K\cos 2\theta_\ell + S_3\sin^2\theta_K\sin^2\theta_\ell\cos 2\phi \right. \\ \left. + S_4\sin 2\theta_K\sin 2\theta_\ell\cos\phi + S_5\sin 2\theta_K\sin\theta_\ell\cos\phi \right. \\ \left. + S_6\sin^2\theta_K\cos\theta_\ell + S_7\sin 2\theta_K\sin\theta_\ell\sin\phi \right. \\ \left. + S_8\sin 2\theta_K\sin 2\theta_\ell\sin\phi + S_9\sin^2\theta_K\sin^2\theta_\ell\sin 2\phi \right],$$

Previously measured (LHCb-PAPER-2013-019; JHEP 08 (2013) 131)  $F_L, S_3, A_{FB} \sim S_6, A_9 \sim S_9$   
 New analysis measures remaining terms, but in a basis with reduced form-factor uncertainty

$$P'_{i=4,5,6,8} = \frac{S_{j=4,5,7,8}}{\sqrt{F_L(1-F_L)}}.$$

Key point is that each observable corresponds to a different angular distribution  
 Therefore each is sensitive to different combinations of operators  $\rightarrow$   
 enhanced sensitivity to possible sources of new physics



# New observables in $B^0 \rightarrow K^{*0} \mu^+ \mu^-$

PRL 111 (2013) 191801

Interesting tension with the SM prediction

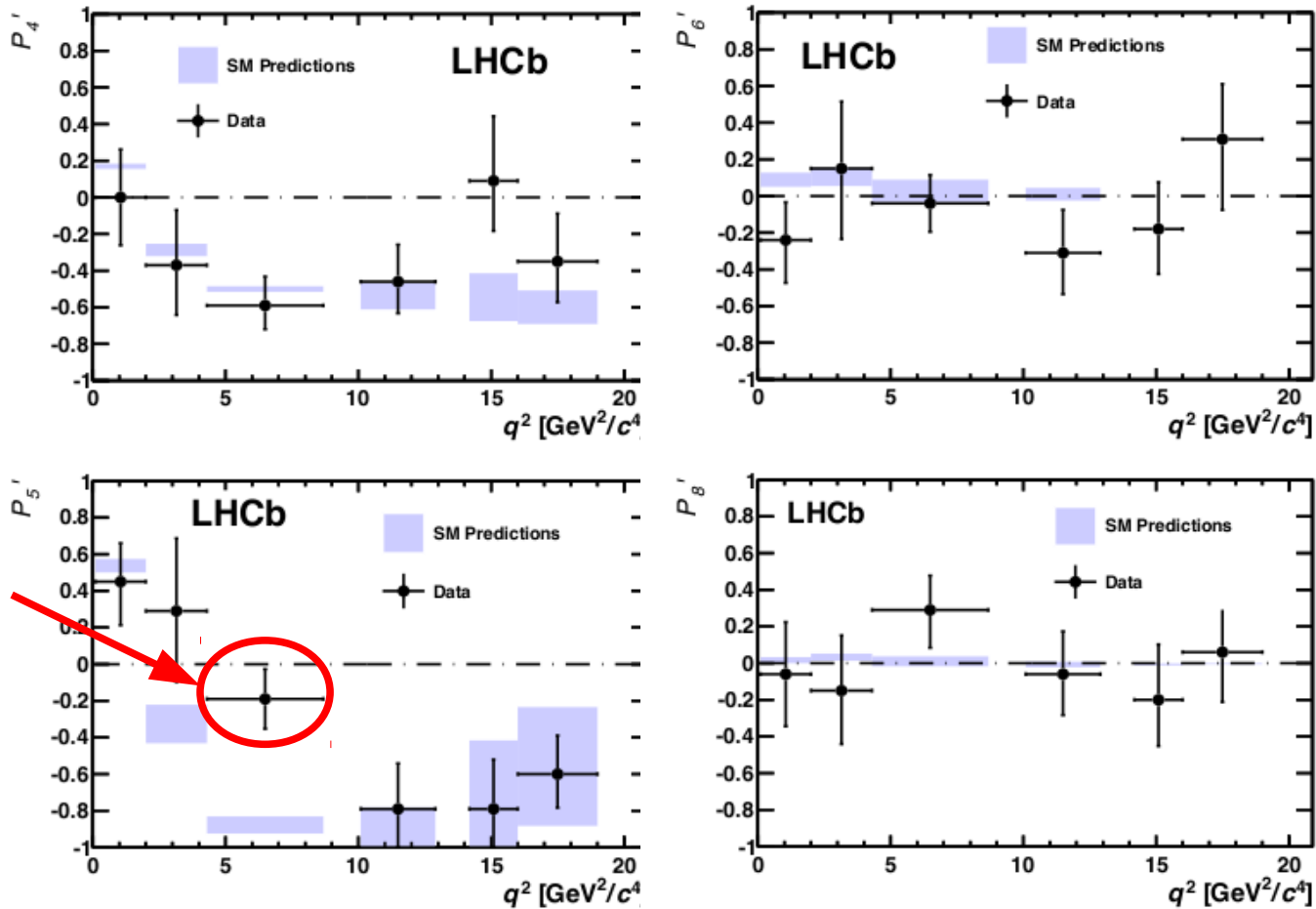

# Future prospects

# Quark flavour physics: short and mid-term projects

- Good short-term prospects with existing experiments
  - LHCb & BES taking new data plus final analyses from completed experiments
  - NA62 and KOTO coming online to probe  $K \rightarrow \pi\nu\nu$  decays
- In the second half of this decade will transition to next generation experiments → very exciting future!
  - Belle2 (start 2016/7) & LHCb upgrade (start 2019)
  - possibilities for  $\tau$ -charm factories in Russia, Turkey, Italy
    - SuperB unfortunately cancelled, however
  - KOTO phase II, ORKA, possible extension of NA62

# LHC upgrade and the all important trigger

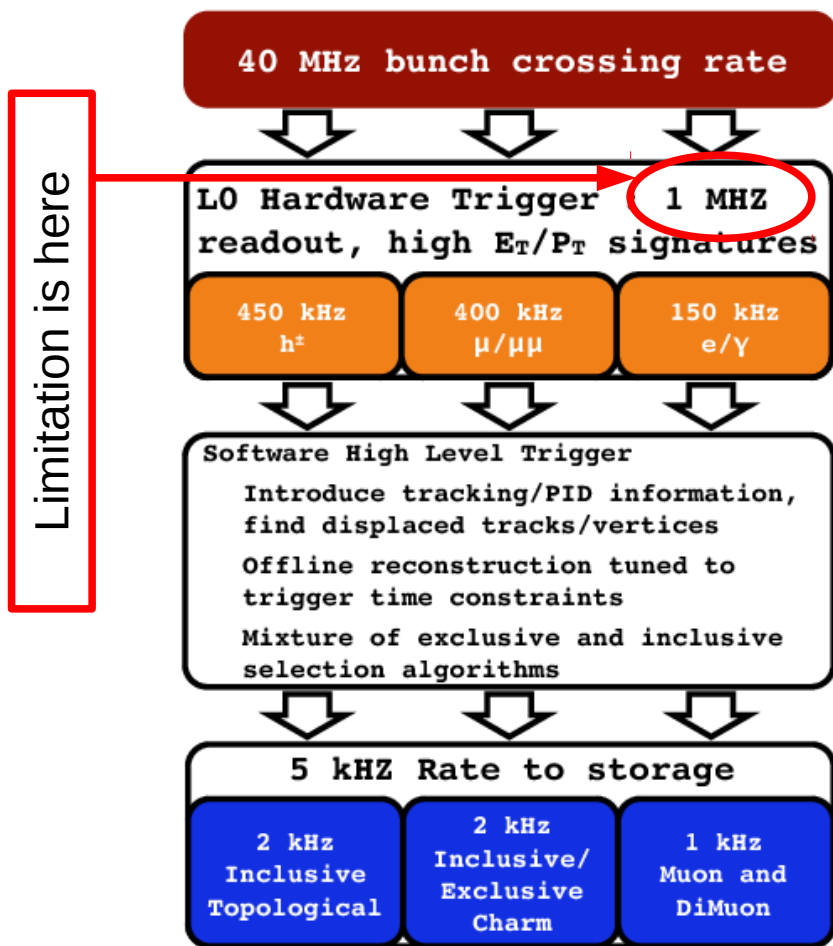

higher luminosity  
 → need to cut harder at L0 to keep rate at 1 MHz  
 → lower efficiency

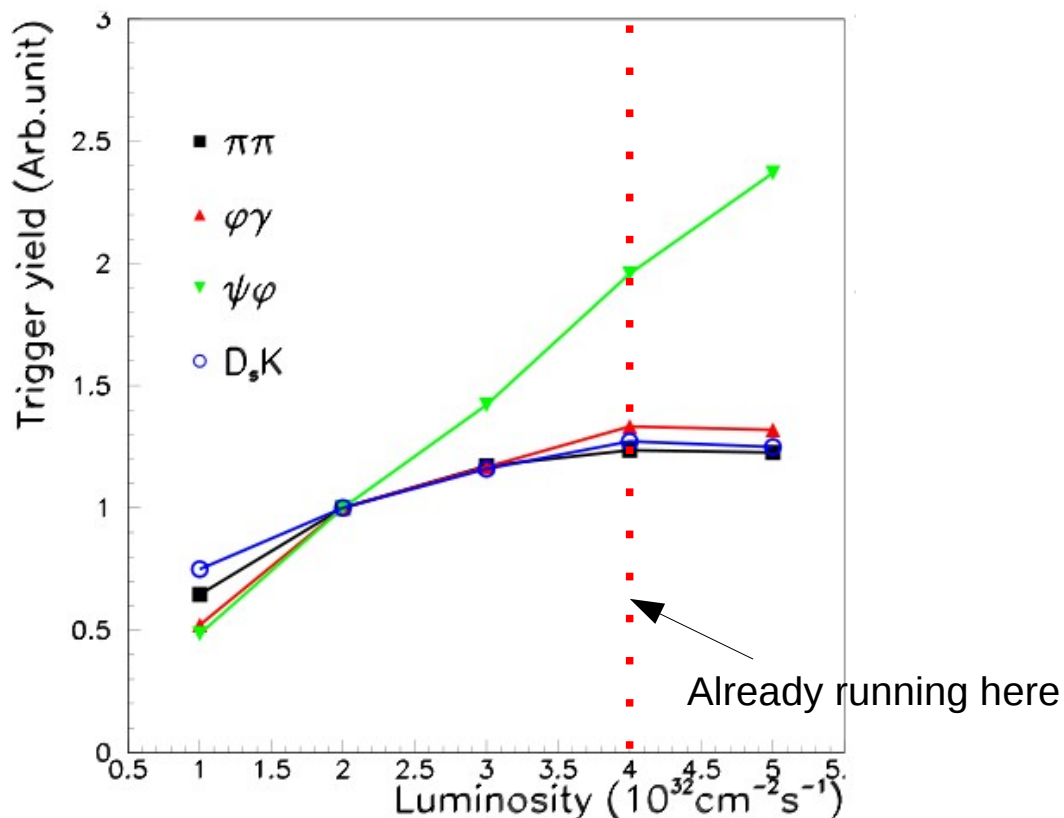

- readout detector at 40 MHz
- implement trigger fully in software → efficiency gains
- run at  $L_{\text{inst}}$  up to  $2 \cdot 10^{33} / \text{cm}^2 / \text{s}$

# LHCb detector upgrade

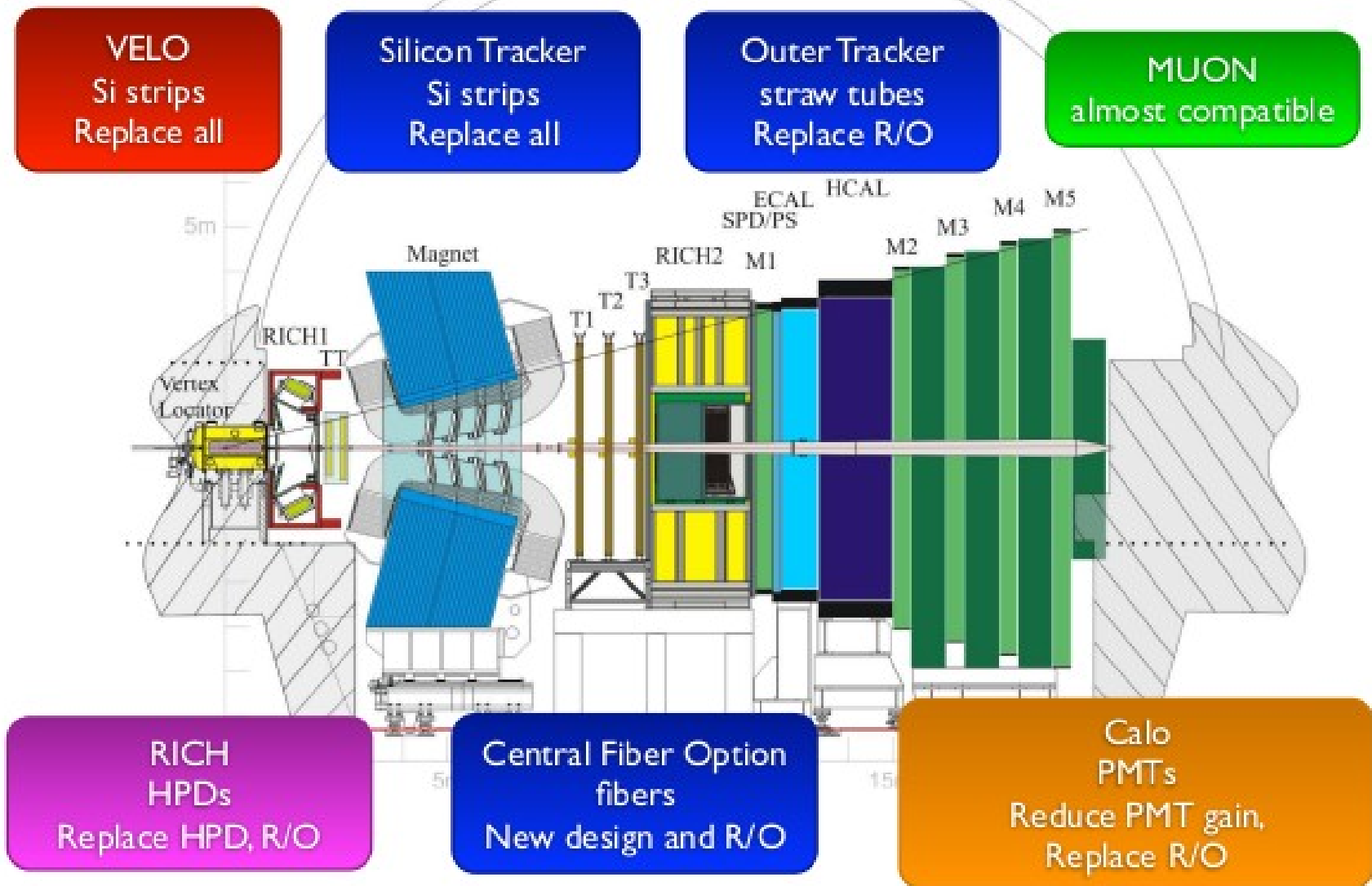

# Upgrade – expected sensitivities

Table 3: Statistical sensitivities of the LHCb upgrade to key observables. For each observable the expected sensitivity is given for the integrated luminosity accumulated by the end of LHC Run 1, by 2018 (assuming  $5 \text{ fb}^{-1}$  recorded during Run 2) and for the LHCb Upgrade ( $50 \text{ fb}^{-1}$ ). An estimate of the theoretical uncertainty is also given – this and the potential sources of systematic uncertainty are discussed in the text.

Type	Observable	LHC Run 1	LHCb 2018	LHCb upgrade	Theory
$B_s^0$ mixing	$\phi_s(B_s^0 \rightarrow J/\psi \phi)$ (rad)	0.05	0.025	<b>0.009</b>	$\sim 0.003$
	$\phi_s(B_s^0 \rightarrow J/\psi f_0(980))$ (rad)	0.09	0.05	<b>0.016</b>	$\sim 0.01$
	$A_{\text{sl}}(B_s^0)$ ( $10^{-3}$ )	2.8	1.4	<b>0.5</b>	0.03
Gluonic penguin	$\phi_s^{\text{eff}}(B_s^0 \rightarrow \phi \phi)$ (rad)	0.18	0.12	<b>0.026</b>	0.02
	$\phi_s^{\text{eff}}(B_s^0 \rightarrow K^{*0} K^{*0})$ (rad)	0.19	0.13	<b>0.029</b>	$< 0.02$
	$2\beta^{\text{eff}}(B^0 \rightarrow \phi K_S^0)$ (rad)	0.30	0.20	<b>0.04</b>	0.02
Right-handed currents	$\phi_s^{\text{eff}}(B_s^0 \rightarrow \phi \gamma)$	0.20	0.13	<b>0.030</b>	$< 0.01$
	$\tau^{\text{eff}}(B_s^0 \rightarrow \phi \gamma)/\tau_{B_s^0}$	5%	3.2%	<b>0.8%</b>	0.2%
Electroweak penguin	$S_3(B^0 \rightarrow K^{*0} \mu^+ \mu^-; 1 < q^2 < 6 \text{ GeV}^2/c^4)$	0.04	0.020	<b>0.007</b>	0.02
	$q_0^2 A_{\text{FB}}(B^0 \rightarrow K^{*0} \mu^+ \mu^-)$	10%	5%	<b>1.9%</b>	$\sim 7\%$
	$A_1(K \mu^+ \mu^-; 1 < q^2 < 6 \text{ GeV}^2/c^4)$	0.14	0.07	<b>0.024</b>	$\sim 0.02$
	$\mathcal{B}(B^+ \rightarrow \pi^+ \mu^+ \mu^-)/\mathcal{B}(B^+ \rightarrow K^+ \mu^+ \mu^-)$	14%	7%	<b>2.4%</b>	$\sim 10\%$
Higgs penguin	$\mathcal{B}(B_s^0 \rightarrow \mu^+ \mu^-)$ ( $10^{-9}$ )	1.0	0.5	<b>0.19</b>	0.3
	$\mathcal{B}(B^0 \rightarrow \mu^+ \mu^-)/\mathcal{B}(B_s^0 \rightarrow \mu^+ \mu^-)$	220%	110%	<b>40%</b>	$\sim 5\%$
Unitarity triangle angles	$\gamma(B \rightarrow D^{(*)} K^{(*)})$	$7^\circ$	$4^\circ$	<b><math>1.1^\circ</math></b>	negligible
	$\gamma(B_s^0 \rightarrow D_s^\mp K^\pm)$	$17^\circ$	$11^\circ$	<b><math>2.4^\circ</math></b>	negligible
	$\beta(B^0 \rightarrow J/\psi K_S^0)$	$1.7^\circ$	$0.8^\circ$	<b><math>0.31^\circ</math></b>	negligible
Charm	$A_\Gamma(D^0 \rightarrow K^+ K^-)$ ( $10^{-4}$ )	3.4	2.2	<b>0.5</b>	–
CP violation	$\Delta A_{\text{CP}}$ ( $10^{-3}$ )	0.8	0.5	<b>0.12</b>	–

- sample sizes in most exclusive B and D final states far larger than those collected elsewhere
- no serious competition in study of  $B_s$  decays and CP violation

# LHCb upgrade timeline

- 2011
  - Letter of Intent: [CERN-LHCC-2011-001](#)
- 2012
  - Framework TDR: [CERN-LHCC-2012-007](#)
    - **Endorsed by LHCC and approved by CERN Research Board** ([minutes](#))
    - LHCb upgrade features prominently in draft European Strategy for Particle Physics
  - See also [arXiv:1208.3355](#) for physics discussion
- **2013**
  - Sub-detector TDRs ← **preparation of TDRs already started**
- 2014-17
  - Final R&D, production and construction
- 2018 (LS2)
  - Installation of upgraded LHCb detector (requires 18 months)

# A lesson from history

- New physics shows up at precision frontier before energy frontier
  - GIM mechanism before discovery of charm
  - CP violation / CKM before discovery of bottom & top
  - Neutral currents before discovery of Z
- Particularly sensitive – loop processes
  - Standard Model contributions suppressed / absent
  - flavour changing neutral currents (rare decays)
  - CP violation
  - lepton flavour / number violation / lepton universality



# The need for more precision

- “Imagine if Fitch and Cronin had stopped at the 1% level, how much physics would have been missed”

– A.Soni

- “A special search at Dubna was carried out by Okonov and his group. They did not find a single  $K_L^0 \rightarrow \pi^+\pi^-$  event among **600 decays** into charged particles (Anikira et al., JETP 1962). At that stage the search was terminated by the administration of the lab. **The group was unlucky.**”

– L.Okun

(remember:  $B(K_L^0 \rightarrow \pi^+\pi^-) \sim 2 \cdot 10^{-3}$ )

# Summary

- Huge recent progress in quark-flavour physics
  - in particular with results from LHCb, which has definitively proved the concept of a forward spectrometer at a hadron collider
- Standard Model survives
  - several “tensions” alleviated with improved measurements
  - further investigation still needed in many areas ( $a_{sl}$ ,  $K^*\mu\mu$ ,  $B \rightarrow D^{(*)}\tau\nu$ , etc.)
  - now probing regions where “realistic” new physics effects might appear
  - looking forward to many new results on full Run 1, and then Run 2, data sets
- Exciting short- and mid-term prospects
  - LHCb upgrade confirmed as a core component of LHC exploitation

Back up

# Range of CKM phenomena

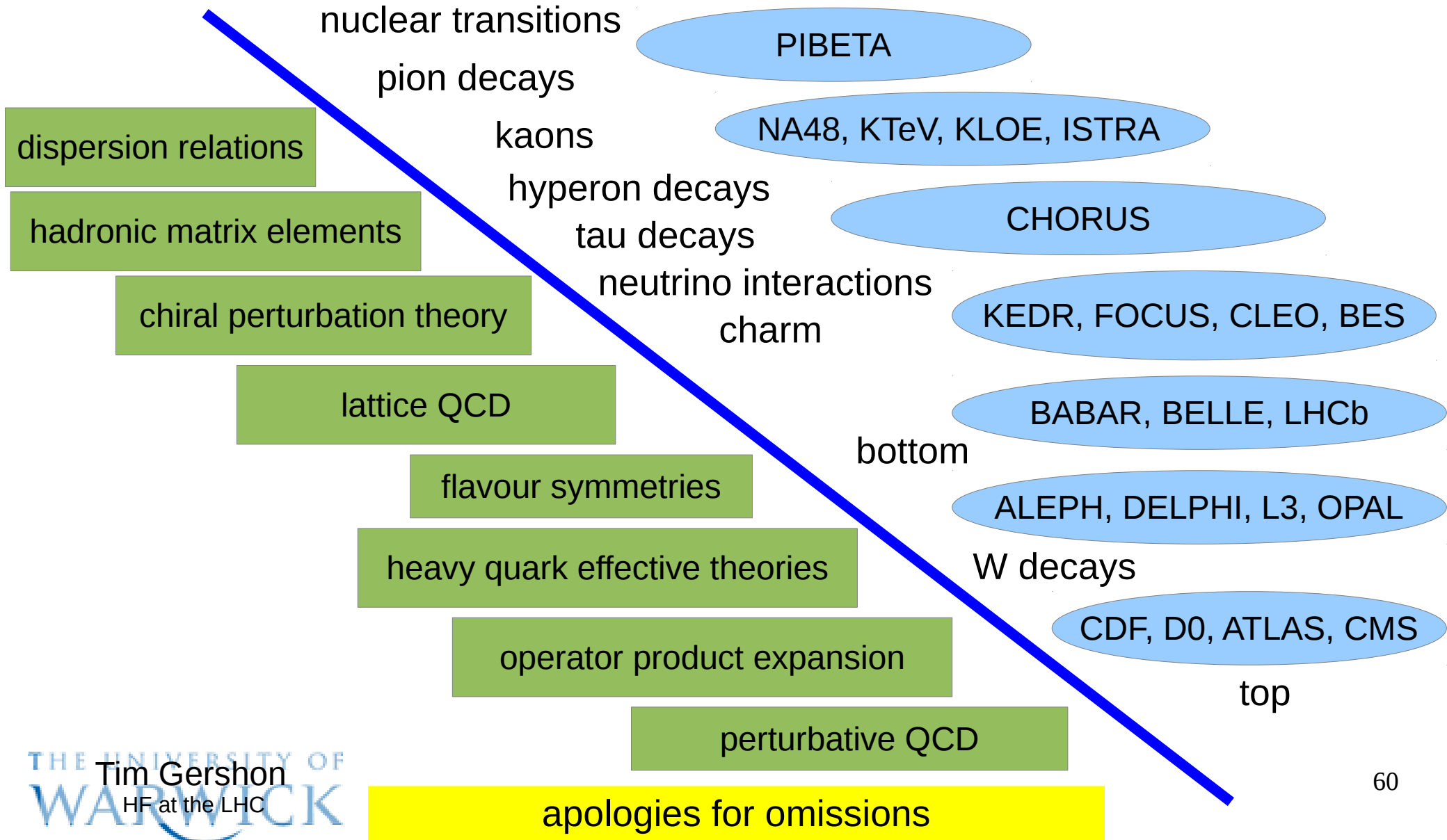

# Heavy flavour production @ ATLAS

“Measurement of the differential cross-sections of inclusive, prompt and non-prompt  $J/\psi$  production in proton-proton collisions at  $\sqrt{s} = 7$  TeV”  
 Nucl. Phys. B 850 (2011) 387

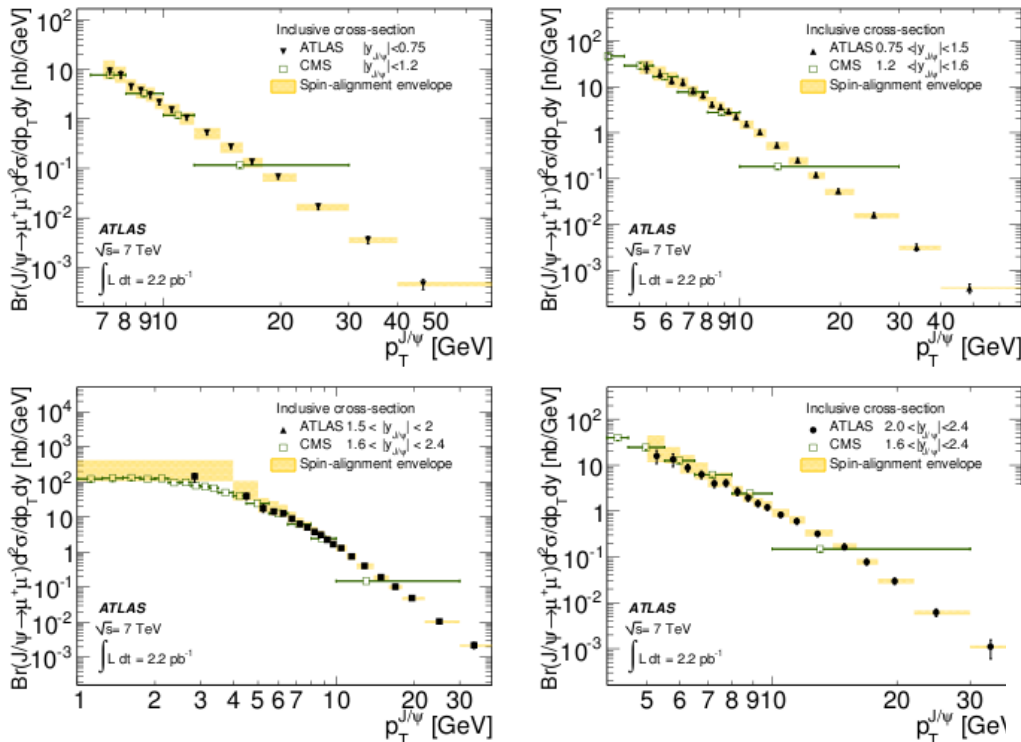

“Measurement of the b-hadron production cross section using decays to  $D^{*+} \mu^- X$  final states in pp collisions at  $\sqrt{s} = 7$  TeV with the ATLAS detector”  
 Nucl. Phys. B 864 (2012) 341

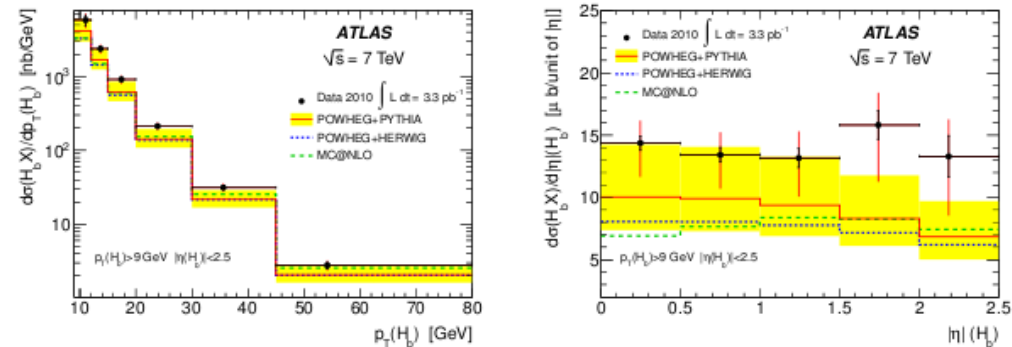

(a)

(b)

# Heavy flavour production @ CMS

“J/ψ and ψ(2S) production in pp collisions  
at  $\sqrt{s} = 7$  TeV”

J. High Energy Phys. 02 (2012) 011

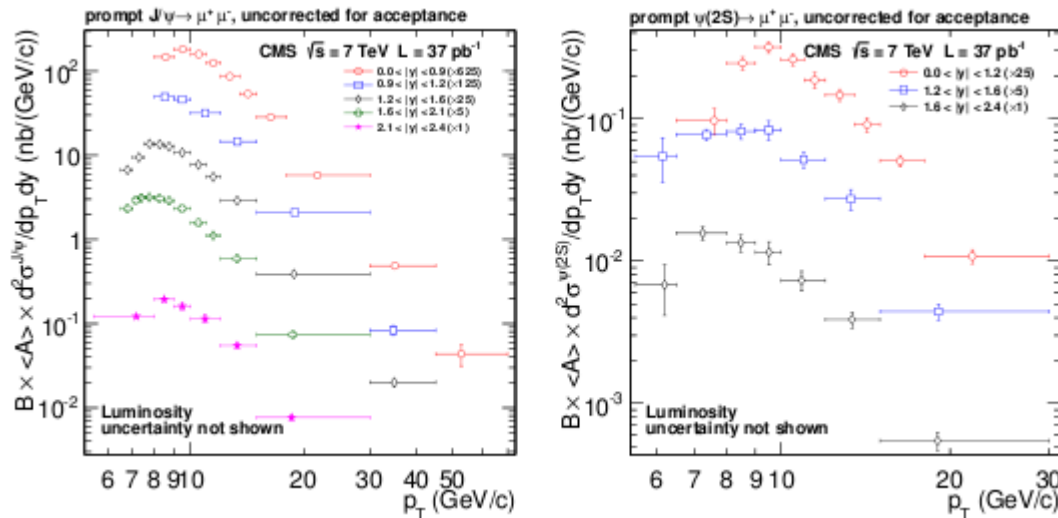

“Measurement of the cross section for  
production of b b-bar X, decaying to  
muons in pp collisions at  $\sqrt{s}=7$  TeV”

J. High Energy Phys. 06 (2012) 110

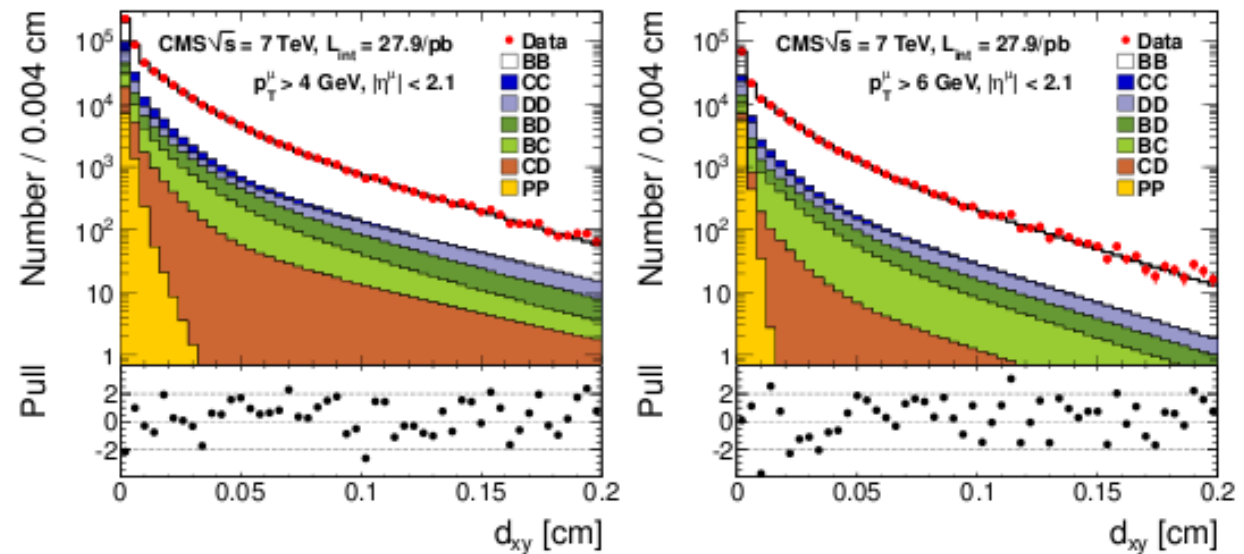

# Heavy flavour production @ LHCb

“Prompt charm production in pp collisions at  $\sqrt{s} = 7$  TeV”  
LHCb-PAPER-2012-041

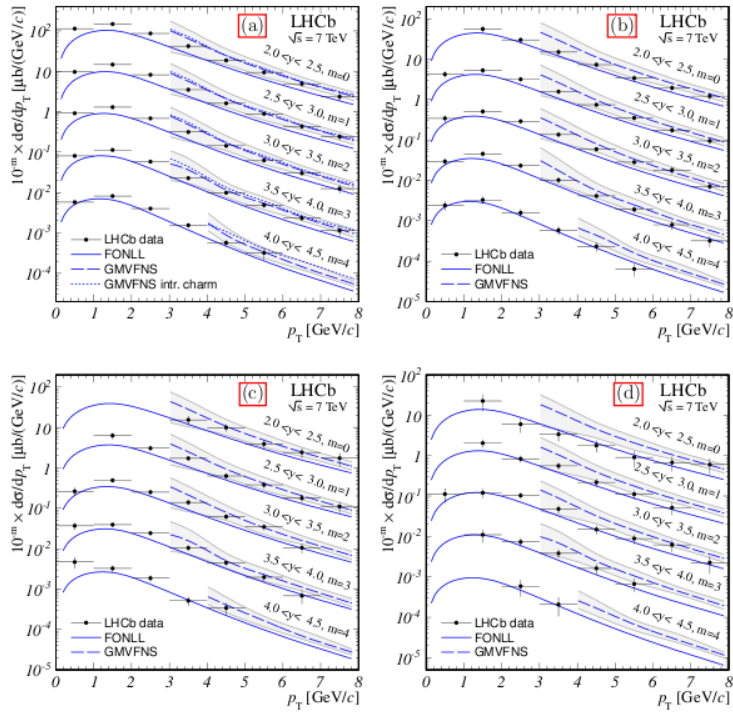

(a)  $D^0$ , (b)  $D^+$ , (c)  $D^{*+}$ , (d)  $D_s^+$

“Measurement of  $J/\psi$  production in pp collisions at  $\sqrt{s} = 7$  TeV”  
Eur. Phys. J. C 71 (2011) 1645

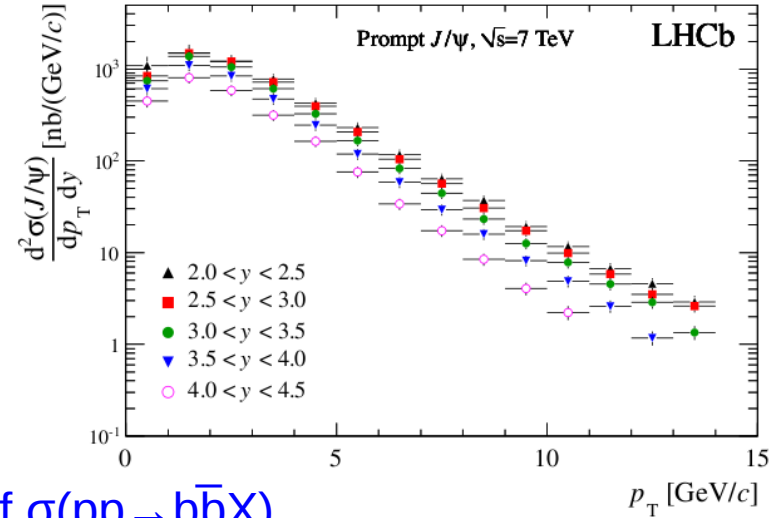

“Measurement of  $\sigma(pp \rightarrow b\bar{b}X)$  at  $\sqrt{s} = 7$  TeV in the forward region”  
Physics Letters B 694 (2010) 209

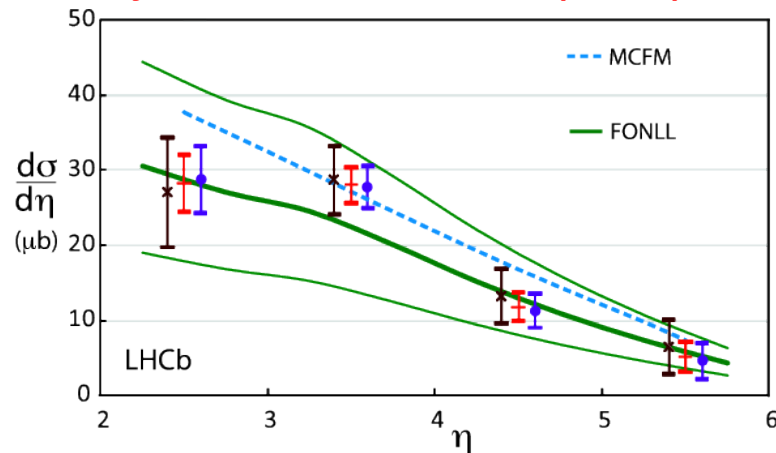

# Unconventional states (II)

## Charged bottomonium-like states

Belle PRL 108 (2012) 122001

Studied in “ $\Upsilon(5S)$ ”  $\rightarrow (b\bar{b})\pi^+\pi^-$  amplitude analyses

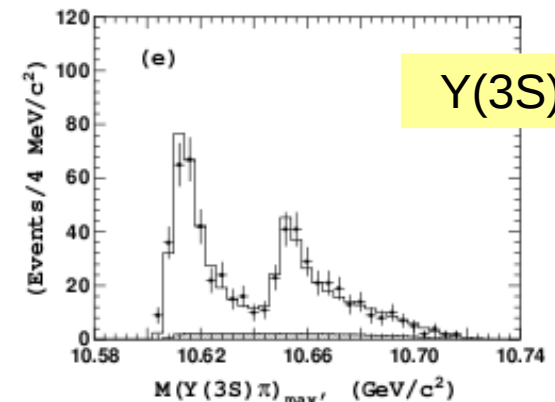
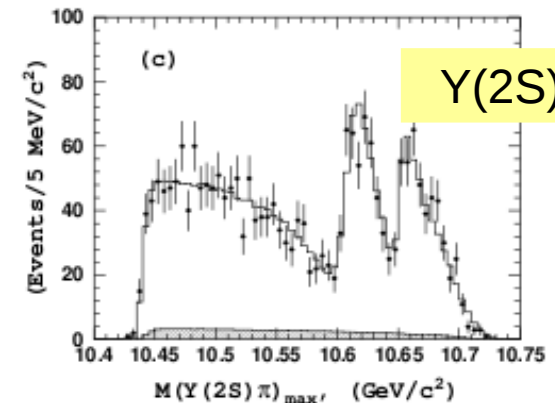
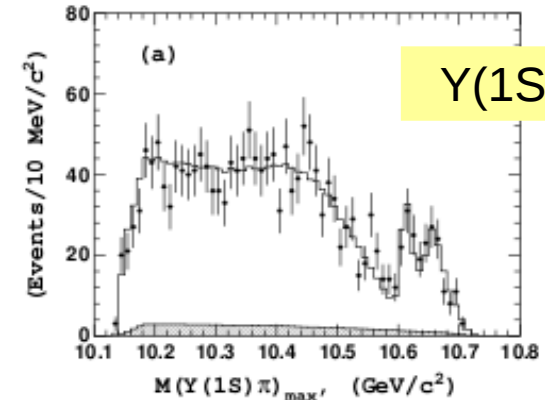
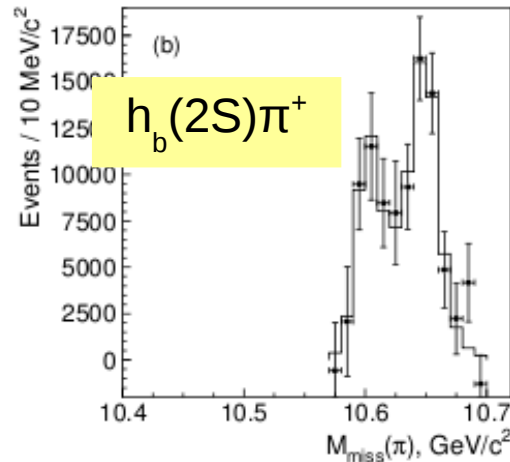
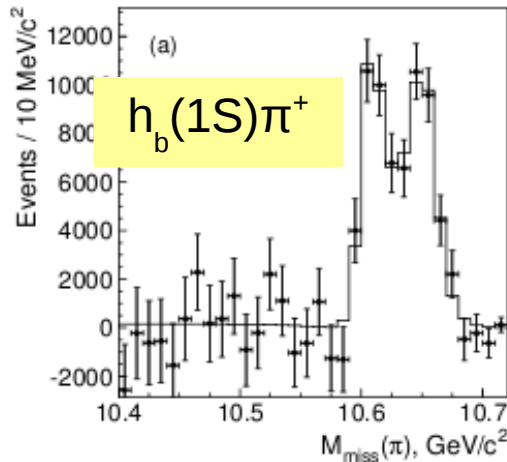

Final state	$\Upsilon(1S)\pi^+\pi^-$	$\Upsilon(2S)\pi^+\pi^-$	$\Upsilon(3S)\pi^+\pi^-$	$h_b(1P)\pi^+\pi^-$	$h_b(2P)\pi^+\pi^-$
$M[Z_b(10610)], \text{MeV}/c^2$	$10611 \pm 4 \pm 3$	$10609 \pm 2 \pm 3$	$10608 \pm 2 \pm 3$	$10605 \pm 2^{+3}_{-1}$	$10599^{+6+5}_{-3-4}$
$\Gamma[Z_b(10610)], \text{MeV}$	$22.3 \pm 7.7^{+3.0}_{-4.0}$	$24.2 \pm 3.1^{+2.0}_{-3.0}$	$17.6 \pm 3.0 \pm 3.0$	$11.4^{+4.5+2.1}_{-3.9-1.2}$	$13^{+10+9}_{-8-7}$
$M[Z_b(10650)], \text{MeV}/c^2$	$10657 \pm 6 \pm 3$	$10651 \pm 2 \pm 3$	$10652 \pm 1 \pm 2$	$10654 \pm 3^{+1}_{-2}$	$10651^{+2+3}_{-3-2}$
$\Gamma[Z_b(10650)], \text{MeV}$	$16.3 \pm 9.8^{+6.0}_{-2.0}$	$13.3 \pm 3.3^{+4.0}_{-3.0}$	$8.4 \pm 2.0 \pm 2.0$	$20.9^{+5.4+2.1}_{-4.7-5.7}$	$19 \pm 7^{+11}_{-7}$
Rel. normalization	$0.57 \pm 0.21^{+0.19}_{-0.04}$	$0.86 \pm 0.11^{+0.04}_{-0.10}$	$0.96 \pm 0.14^{+0.08}_{-0.05}$	$1.39 \pm 0.37^{+0.05}_{-0.15}$	$1.6^{+0.6+0.4}_{-0.4-0.6}$
Rel. phase, degrees	$58 \pm 43^{+4}_{-9}$	$-13 \pm 13^{+17}_{-8}$	$-9 \pm 19^{+11}_{-26}$	$187^{+44+3}_{-57-12}$	$181^{+65+74}_{-105-109}$

Interpretation of  $Z_b^+$  states as  $B^{(*)}B^*$  molecules



# Unconventional states (III)

## Charged charmonium-like states

BESIII PRL 110 (2013) 252001  
& Belle PRL 110 (2013) 252002

Studied in  $Y(4260) \rightarrow J/\psi \pi^+ \pi^-$   
*not* amplitude analysis

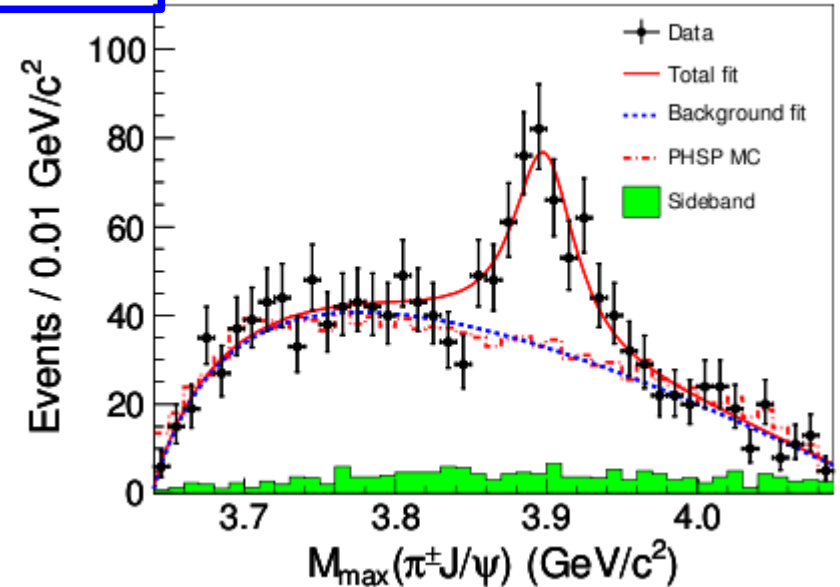
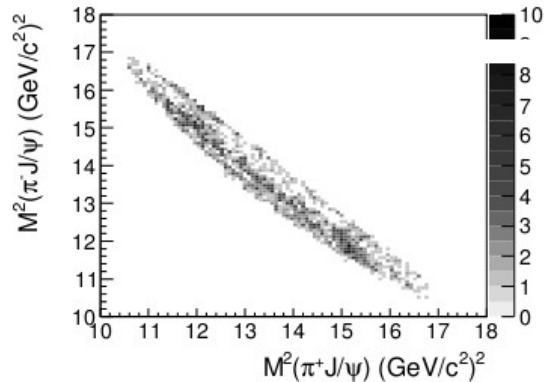
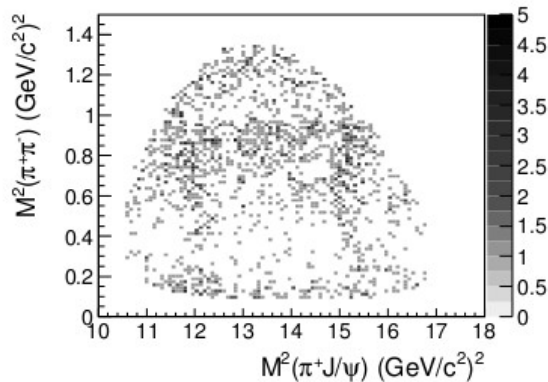

$Z_c(3900)$  adds to a list of claimed charged charmonium-like states

( $Z(4430)$  in  $\psi'\pi^+$ ,  $Z_1(4050)$ ,  $Z_2(4250)$  in  $\chi_{c1}\pi^+$ )

**Independent confirmations (or refutations) needed ...**

Careful amplitude analyses are necessary to understand broad peaks

“The story of the pentaquark shows how poorly we understand QCD” – F. Wilczek, 2005  
→ are we approaching understanding beyond  $q\bar{q}$  and  $qqq$ ?

# The smoking gun exotic hadron: A charged charmonium-like state

$$B^0 \rightarrow Z(4430)^- K^+, Z(4430)^- \rightarrow \psi' \pi^-$$

Belle PRL 100 (2008) 142001

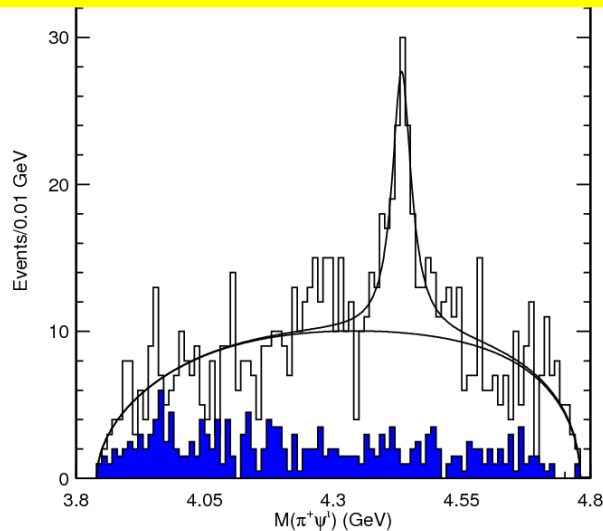

Clear peak

Still there in more detailed analysis

PRD 80 (2009) 031104

BABAR PRD 79 (2009) 112001

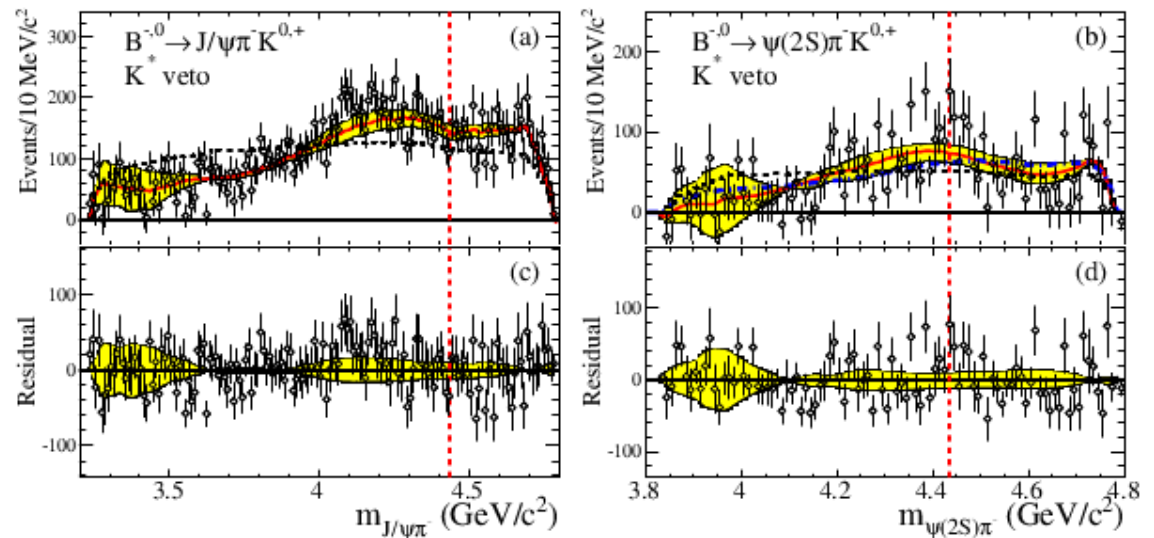

Data consistent with  $K\pi$  reflections

Slight peak but no evidence for new state

But also consistent with Belle

Need more experimental input  
(CDF, D0, ATLAS, CMS or LHCb)

# Large CP violation effects exist $\sin(2\beta)$ from $B^0 \rightarrow J/\psi K_S^0$

**BABAR**

**BELLE**

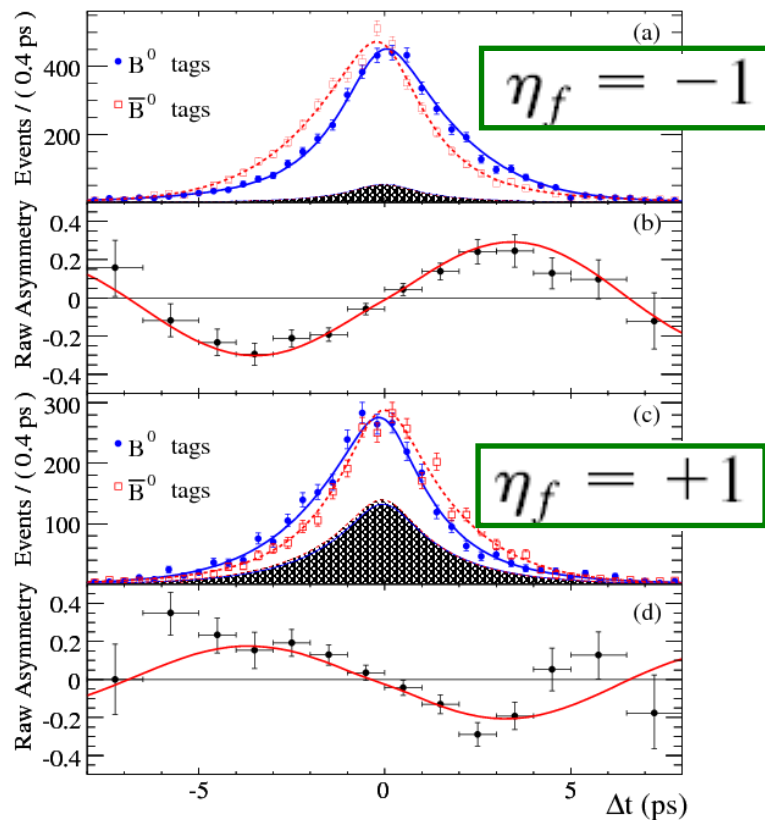

PRD 79 (2009) 072009

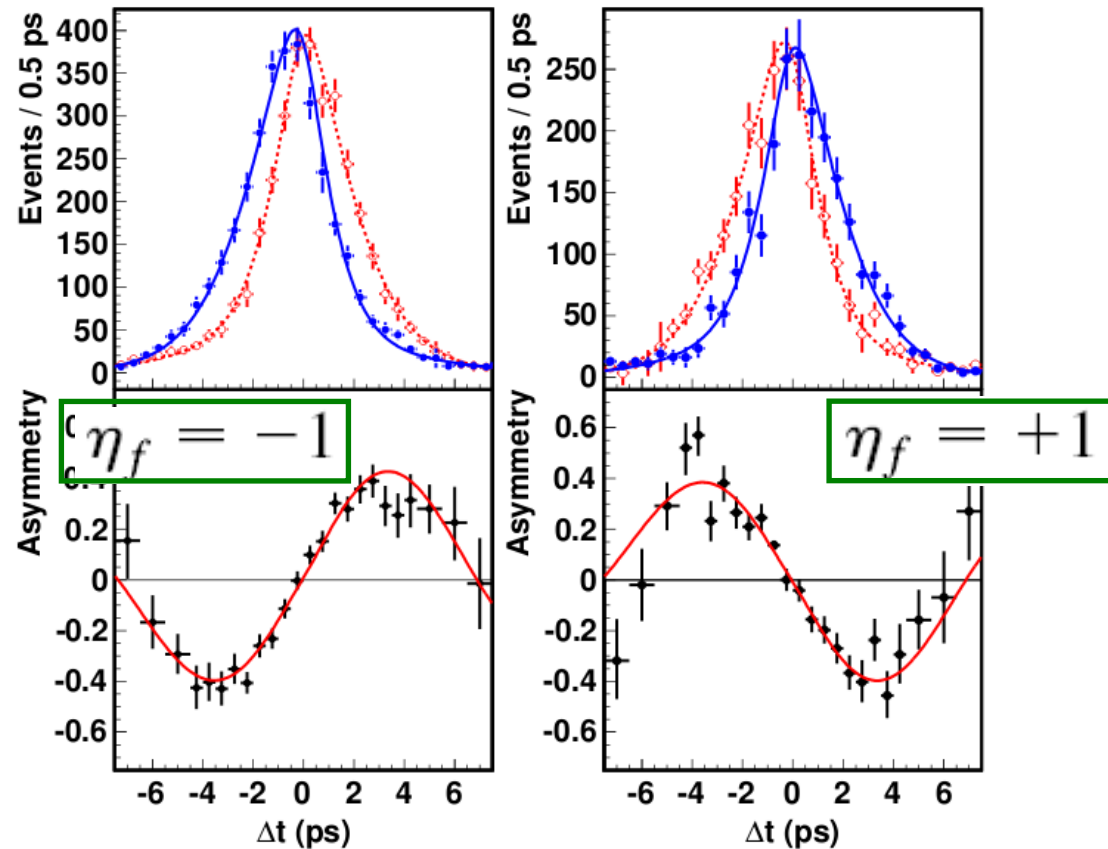

PRL 108 (2012) 171802

World average:  $\sin(2\beta) = 0.679 \pm 0.020$

# ... and T is also violated, as expected

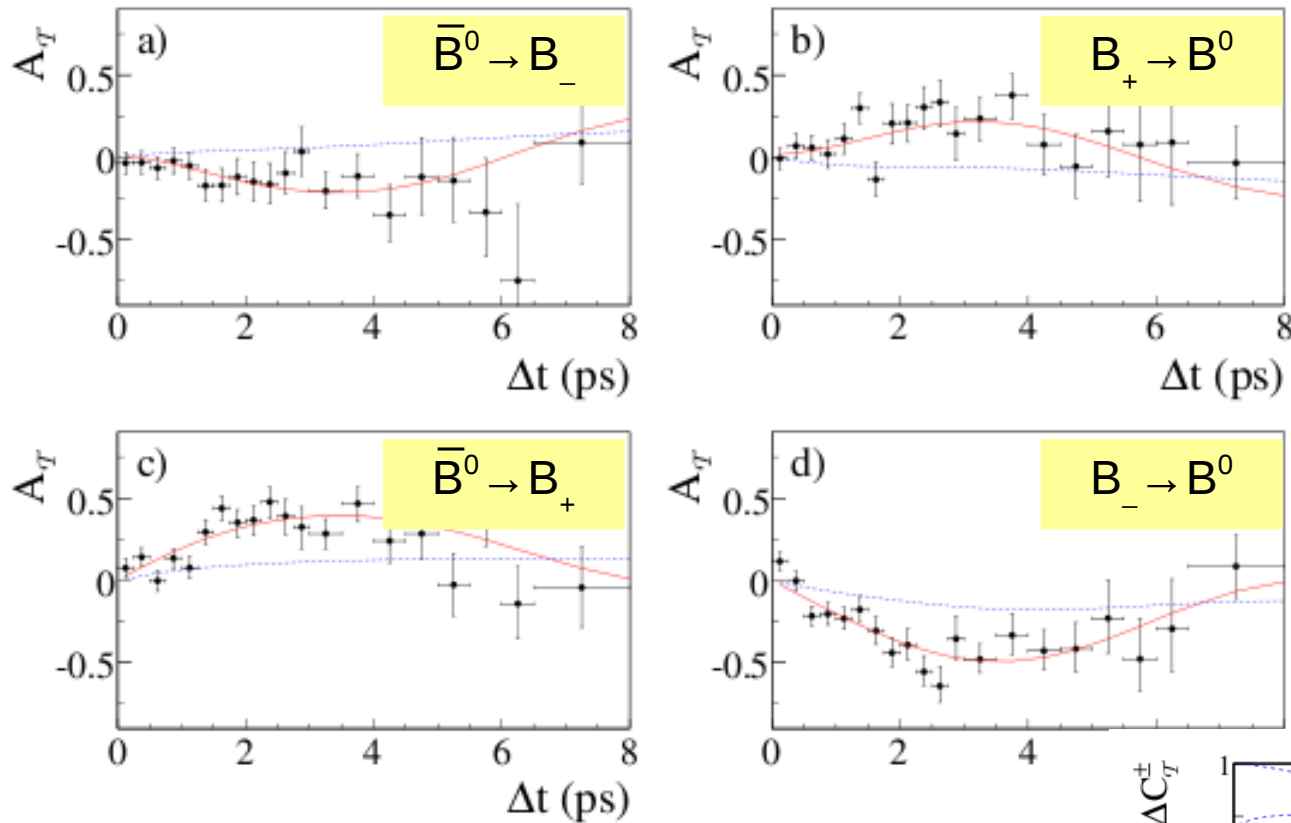

BaBar  
PRL 109 (2012) 211801

Generalisation of usual  $\sin(2\beta)$  analysis allowing for separate CP, T and CPT violating terms

No significant sign of CPT violation in any test

e.g.  $A_T(\bar{B}^0 \rightarrow B_-)$  between  $(l^- \text{ tag}, J/\psi K_S, \Delta t > 0)$   
and  $(l^+ \text{ tag}, J/\psi K_L, \Delta t < 0)$   
 $\sim \frac{1}{2}(\Delta S_T^+ \sin(\Delta m_d \Delta t) + \Delta C_T^+ \cos(\Delta m_d \Delta t))$

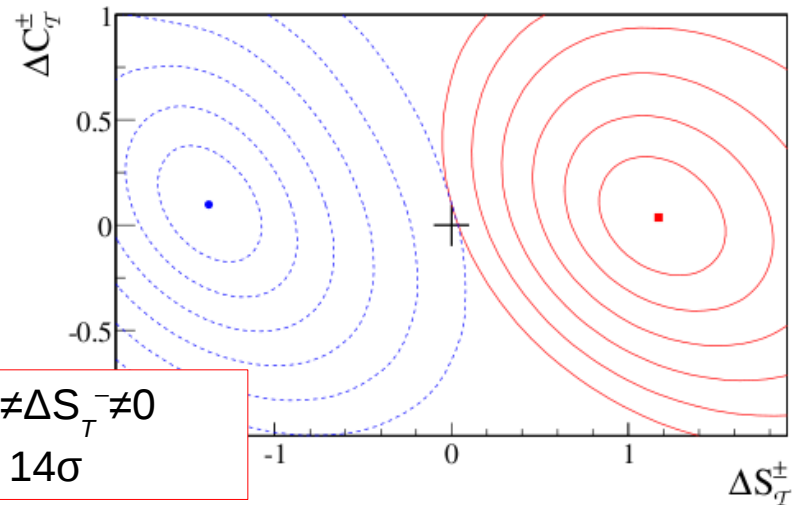

Contours show  $\Delta S_T^+ \neq \Delta S_T^- \neq 0$   
→ T violation at  $14\sigma$

# $\gamma$ from $B^+ \rightarrow DK^+, D \rightarrow K_S^0 h^+ h^-$

LHCb (1/fb)  
Phys. Lett. B 718 (2012) 43

- Results from “GGSZ” mode very important to break ambiguities in determination of  $\gamma$
- Model-independent approach using  $D \rightarrow K_S^0 \pi^+ \pi^-$  and (world first)  $D \rightarrow K_S^0 K^+ K^-$

$K_S^0 \pi^+ \pi^-$  in two  
 $K_S^0$  categories

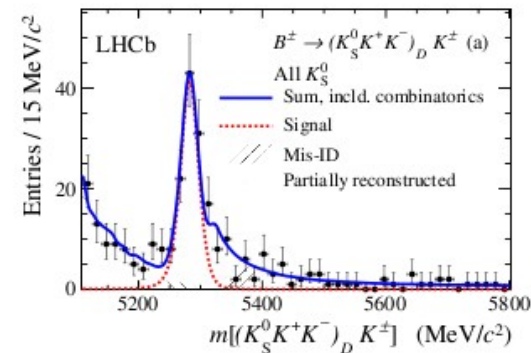
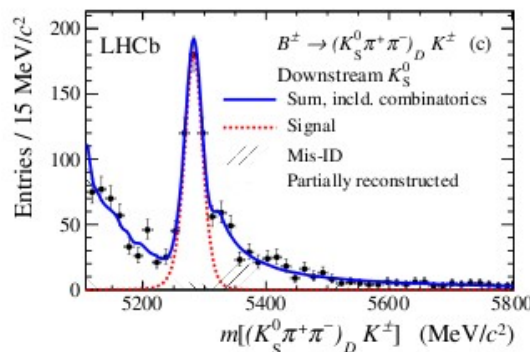
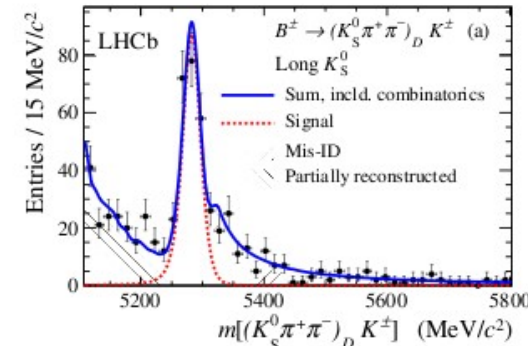

$K_S^0 K^+ K^-$   
(all combined)

# $\gamma$ from $B^+ \rightarrow DK^+$ , $D \rightarrow K_S^0 h^+ h^-$

LHCb (1/fb)  
Phys. Lett. B 718 (2012) 43

Reconstruct Dalitz plot distributions ...

... bin them ...

(in complicated but ~optimal way)

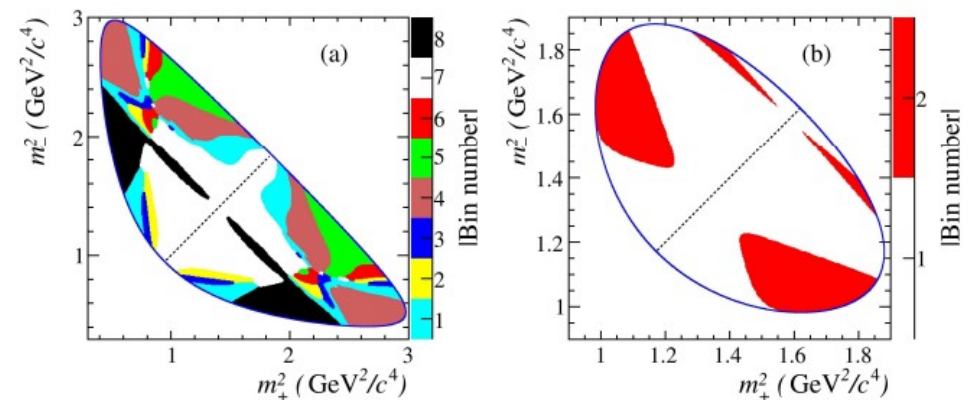
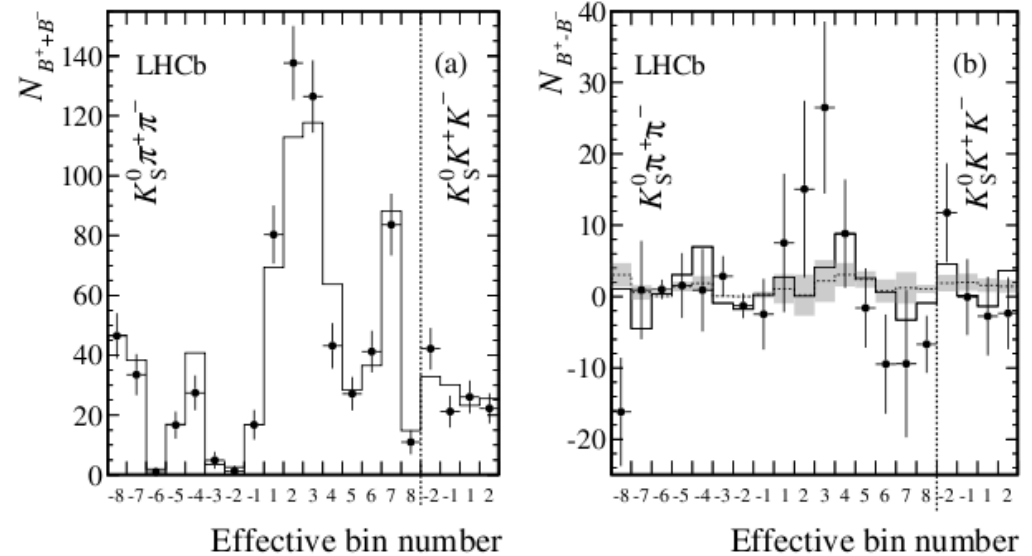
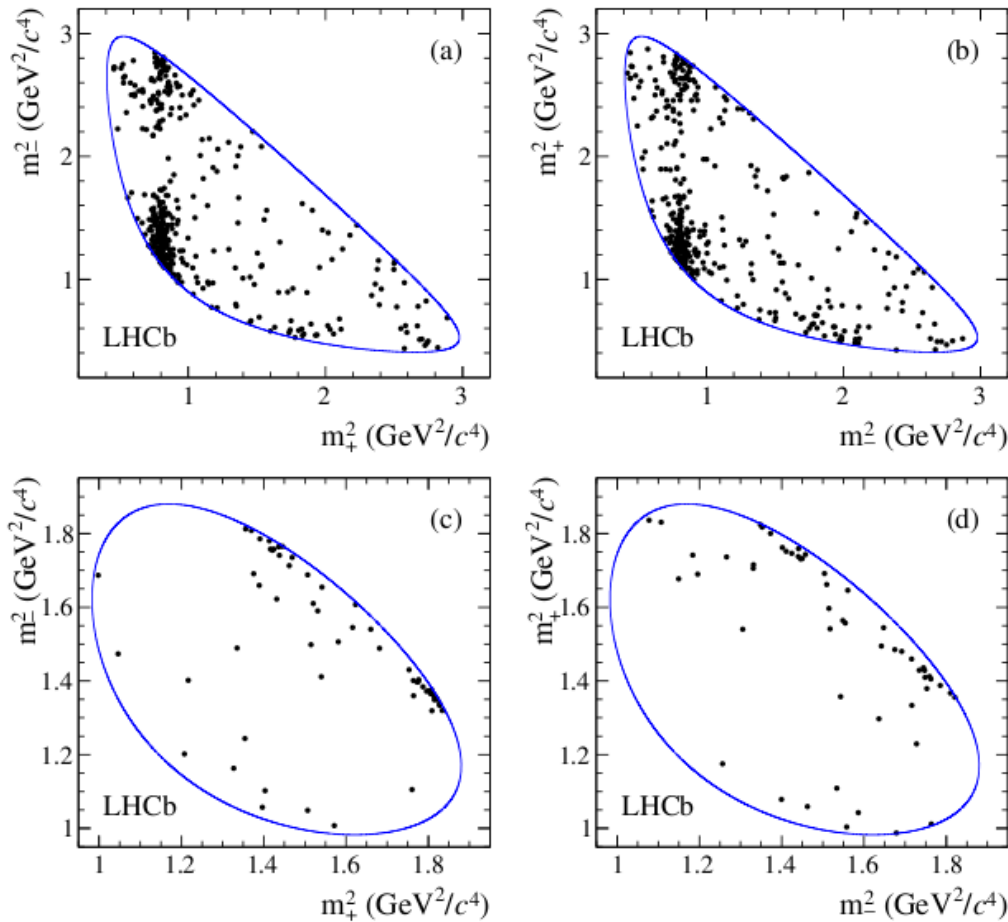

# $\gamma$ from $B^+ \rightarrow DK^+$ , $D \rightarrow K_S^0 h^+ h^-$

LHCb (1/fb)  
Phys. Lett. B 718 (2012) 43

Reconstruct Dalitz plot distributions ...

... bin them ...

(in complicated but ~optimal way)

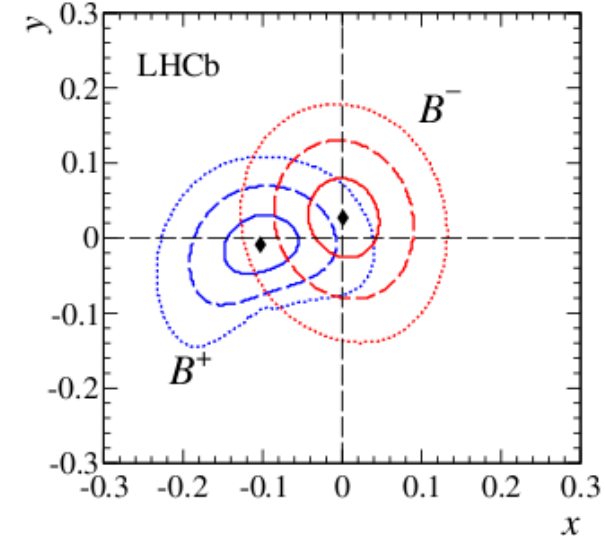
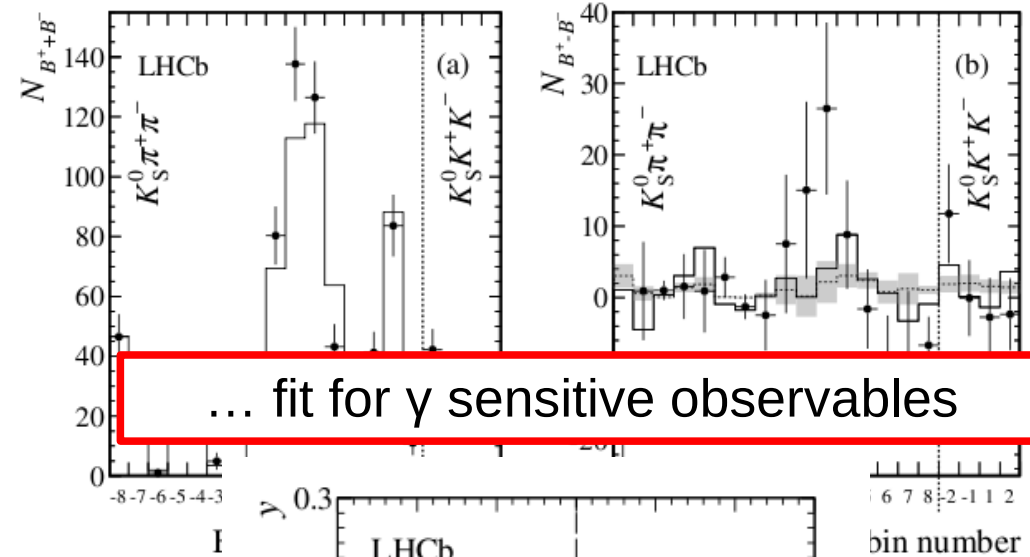
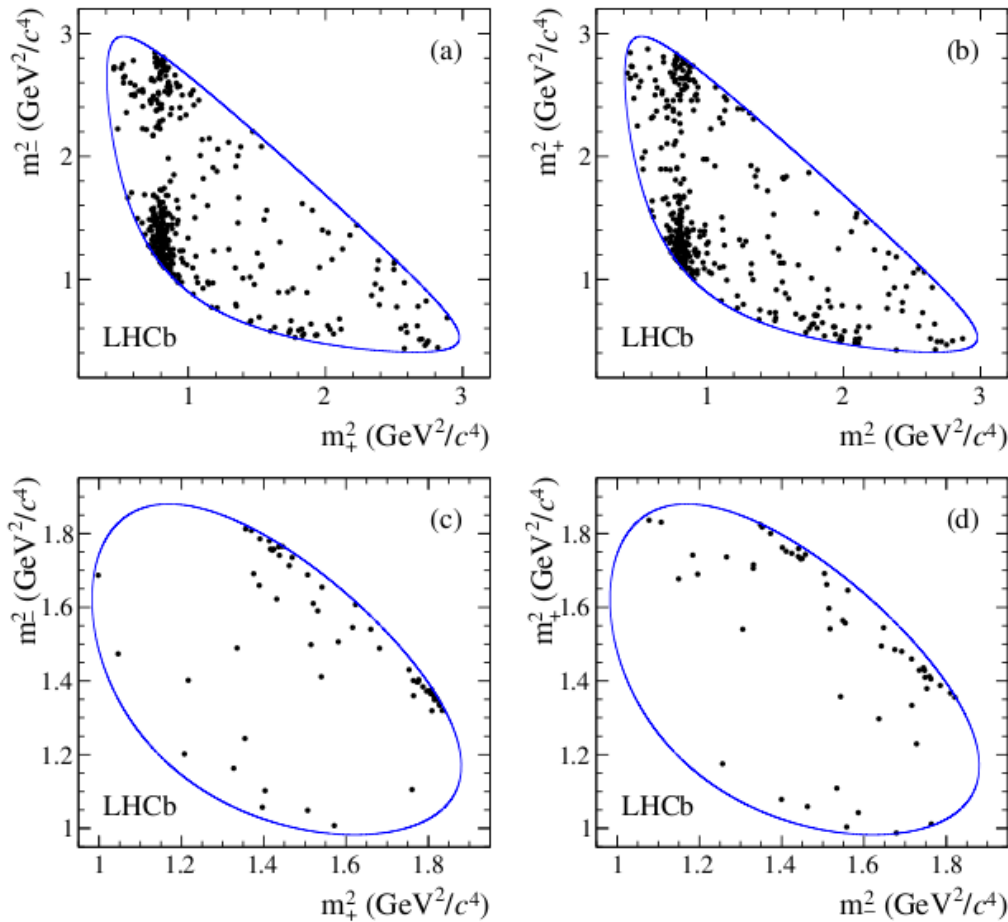

# B → TV & B → D<sup>(\*)</sup>TV

BaBar arXiv:1207.0698  
 Belle arXiv:1208.4678  
 M. Nakao @ ICHEP 2012

BaBar PRL 109 (2012) 101802  
 Belle PRD 82 (2010) 072005

- BaBar [468M] (2010) semilep-tag
- BaBar [468M] (2012) hadronic-tag
- BaBar (combined) with correlations
- Belle [657M] (2010) semilep-tag
- Belle [772M] (2012) hadronic-tag
- Belle (combined) with correlations
- W.A. private average (MN)

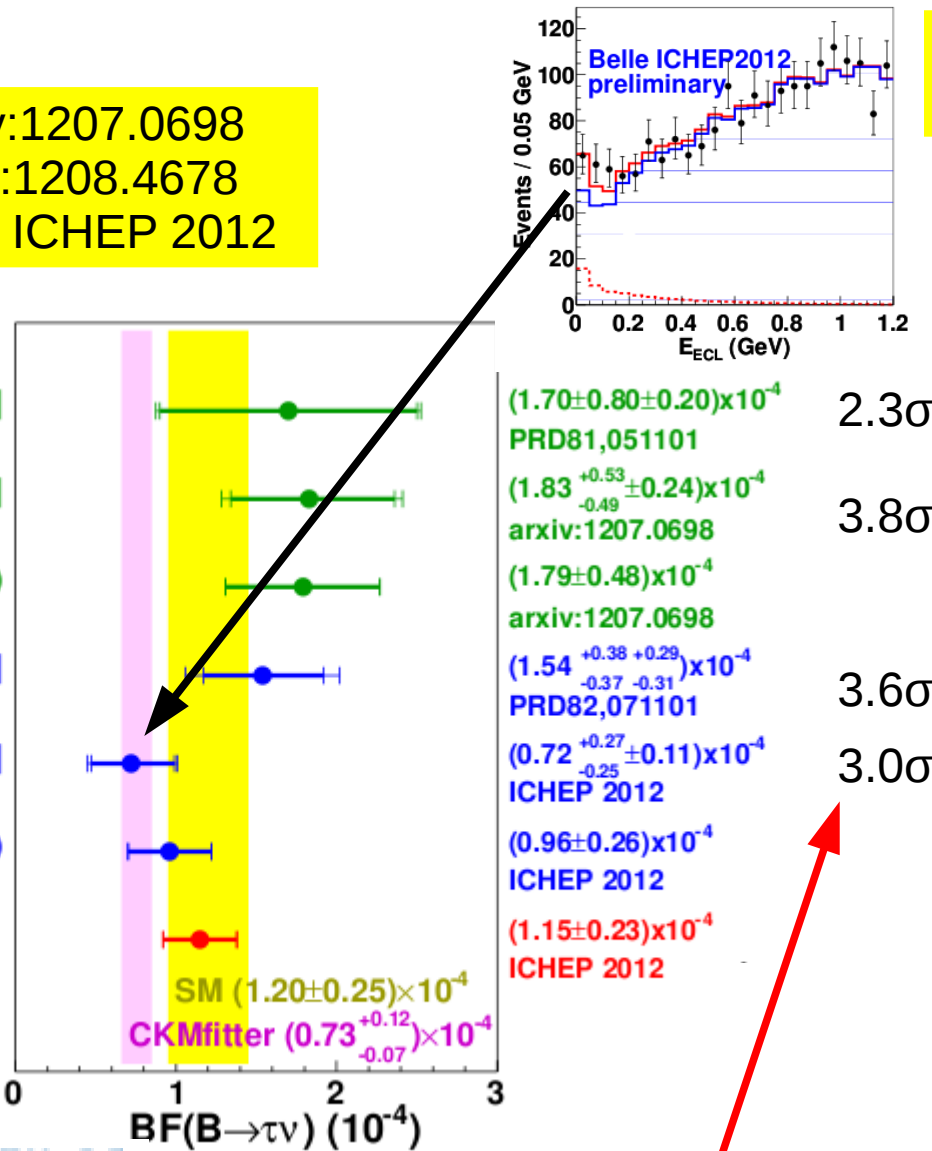

Significance (from 0) below the usual threshold to claim observation

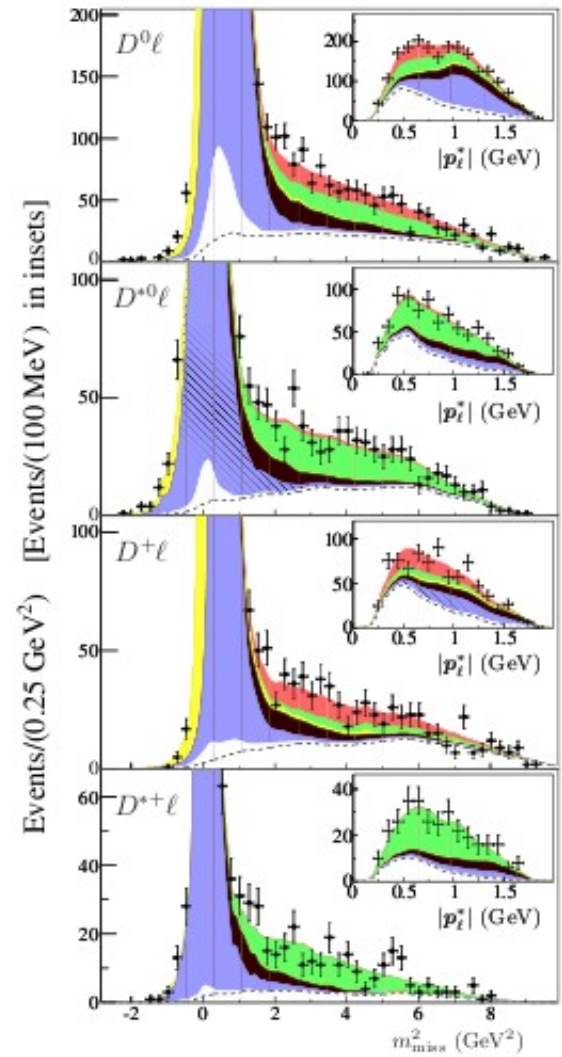

BaBar rates 3.4 $\sigma$  above the SM,  
 and inconsistent with 2HDM



# $|V_{ub}|$ from {in,ex}clusive semileptonic decays

PBFLB based on  
 BaBar PRD 83 (2011) 052011 &  
 PRD 83 (2011) 032007  
 Belle PRD 83 (2011) 071101(R)

Some tension between exclusive and inclusive results. PBFLB concludes:

$$|V_{ub}|_{\text{excl}} = [3.23 (1 \pm 0.05_{\text{exp}} \pm 0.08_{\text{th}})] \times 10^{-3}$$

$$|V_{ub}|_{\text{incl}} = [4.42 (1 \pm 0.045_{\text{exp}} \pm 0.034_{\text{th}})] \times 10^{-3}$$

This average has a probability of  $P(\chi^2) = 0.003$ . Thus we scale the error by  $\sqrt{\chi^2} = 3.0$  and arrive at

$$|V_{ub}| = [3.95 (1 \pm 0.096_{\text{exp}} \pm 0.099_{\text{th}})] \times 10^{-3}$$

Similar tension also for  $|V_{cb}|$

Better understanding needed to reduce uncertainty

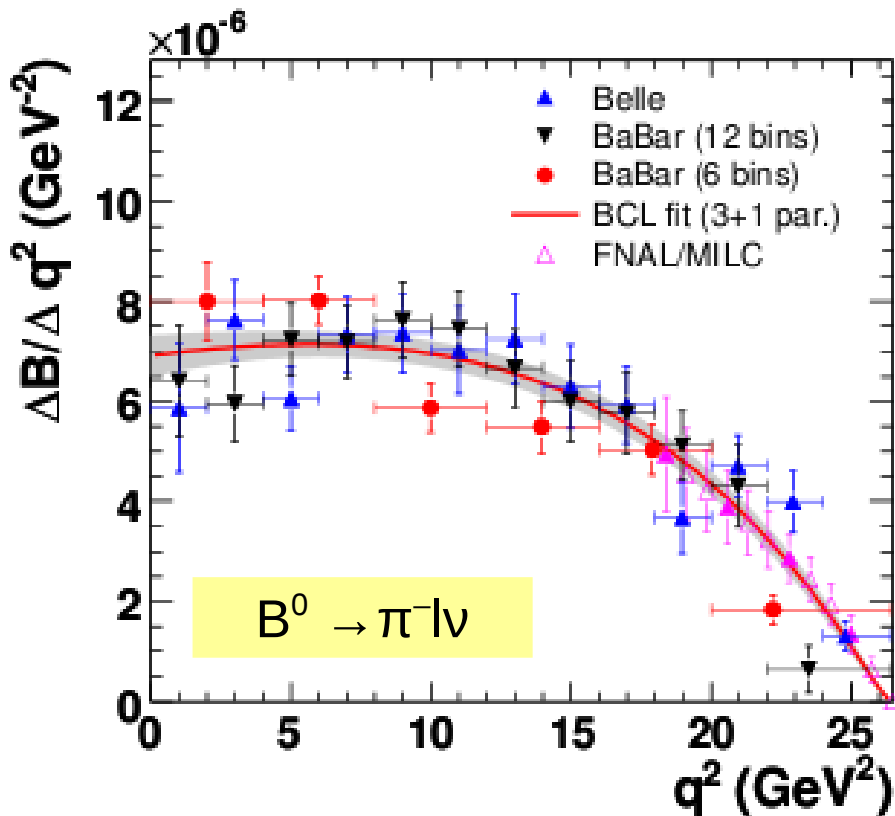

# KEKB to SuperKEKB



Colliding bunches

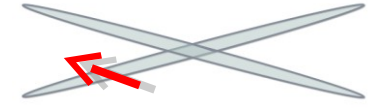

New superconducting / permanent final focusing quads near the IP

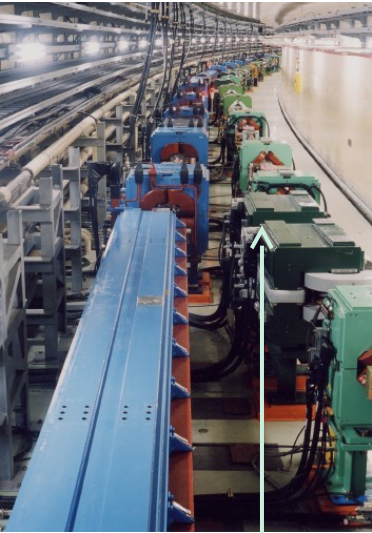
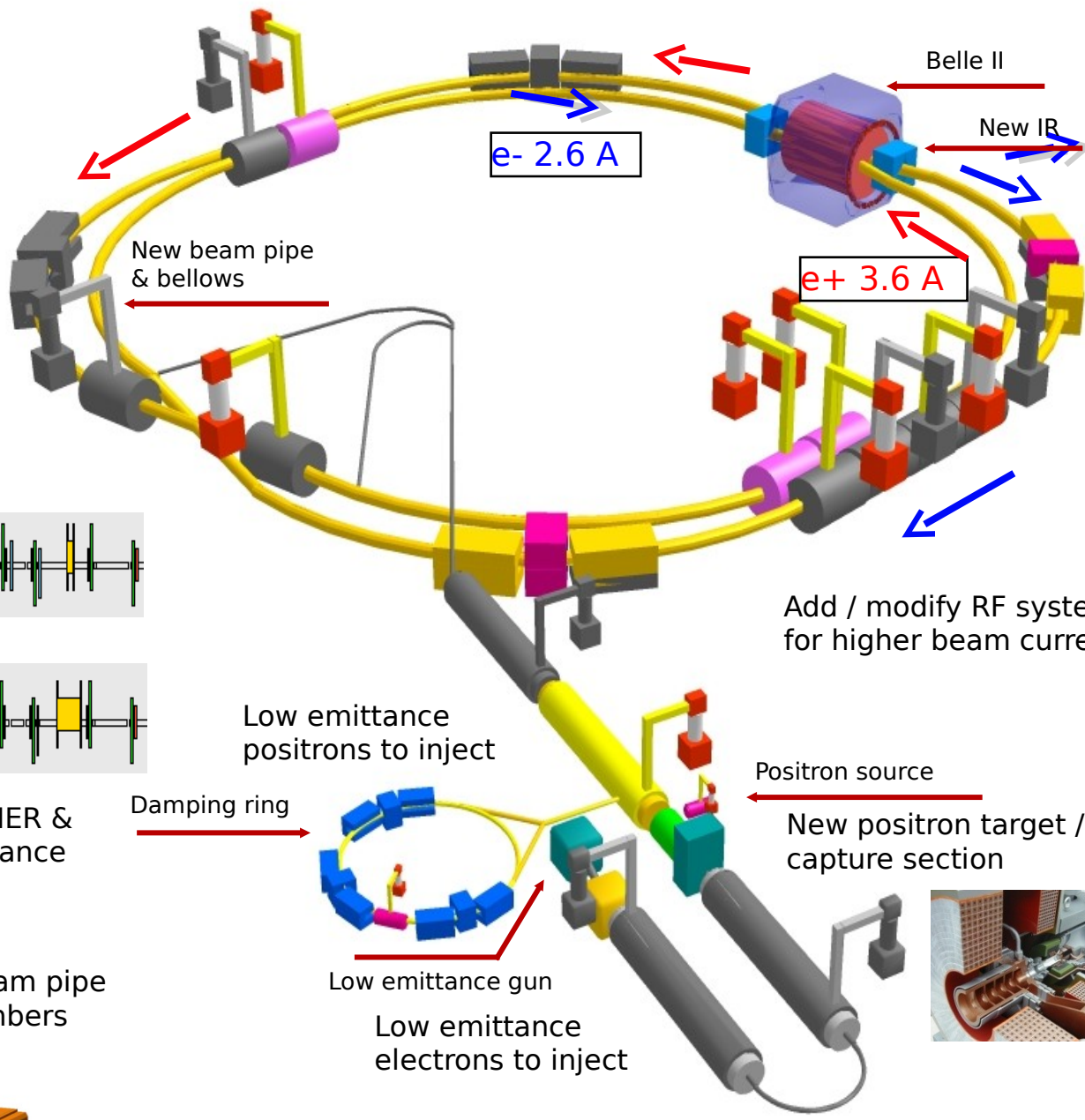
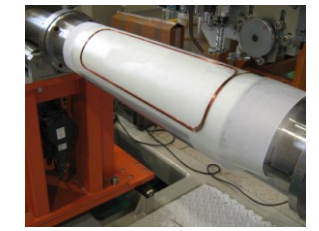

Replace short dipoles with longer ones (LER)

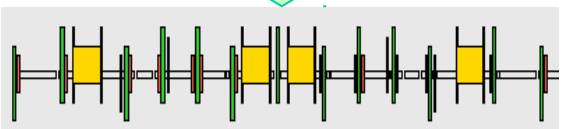
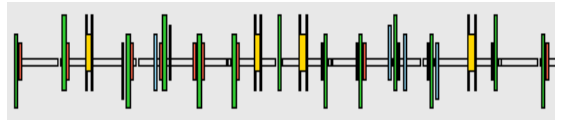

Redesign the lattices of HER & LER to squeeze the emittance

TiN-coated beam pipe with antechambers

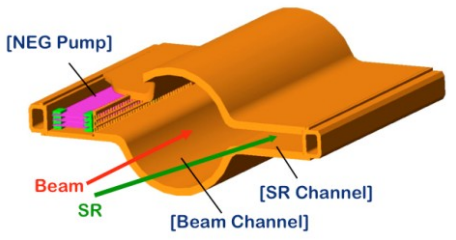

Add / modify RF systems for higher beam current



Low emittance positrons to inject

Damping ring

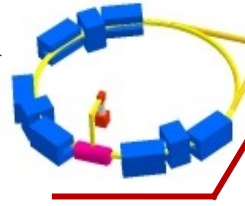

Low emittance gun  
Low emittance electrons to inject

Positron source

New positron target / capture section

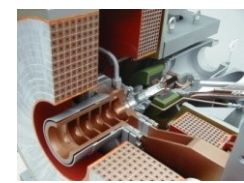

**To obtain x40 higher luminosity**

# Belle II Detector



KL and muon detector:  
Resistive Plate Counter (barrel outer layers)  
Scintillator + WLSF + MPPC (end-caps, inner 2 barrel layers)

EM Calorimeter:  
CsI(Tl), waveform sampling (barrel)  
Pure CsI + waveform sampling (end-caps)

electrons (7GeV)

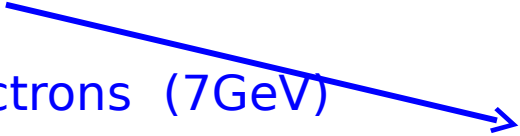

Particle Identification  
Time-of-Propagation counter (barrel)  
Prox. focusing Aerogel RICH (fwd)

Beryllium beam pipe  
2cm diameter

Vertex Detector  
2 layers DEPFET + 4 layers DSSD

Central Drift Chamber  
He(50%):C<sub>2</sub>H<sub>6</sub>(50%), small cells,  
long lever arm, fast electronics



positrons  
(4GeV)



# Belle II Detector (in comparison with Belle)

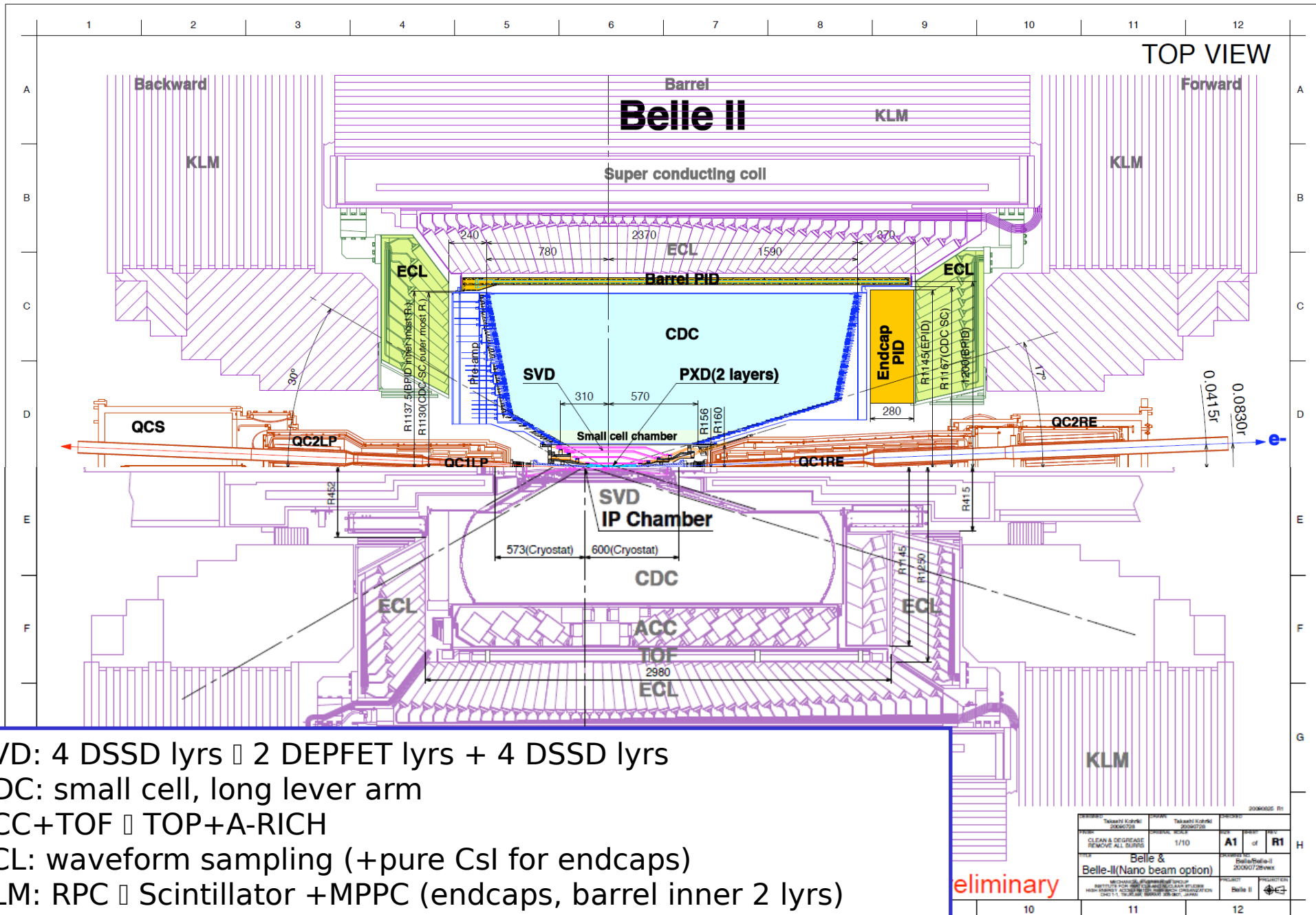

SVD: 4 DSSD lyrs + 2 DEPFET lyrs + 4 DSSD lyrs  
 CDC: small cell, long lever arm  
 ACC+TOF + TOP+A-RICH  
 ECL: waveform sampling (+pure CsI for endcaps)  
 KLM: RPC + Scintillator +MPPC (endcaps, barrel inner 2 lyrs)

eliminary

Task: Takashi Kobayashi 20060728	Project: Belle & Belle-II(Nano beam option)	Version: 1/10	Page: A1 of R1
CLEAN & DECREASE REMOVE ALL SURFS PROJECT: Belle II INSTITUTION: KEK HIGH ENERGY ACCELERATOR RESEARCH ORGANIZATION CHS-11, TSUKUBA, IBARAKI, 305-8565, JAPAN			

# Schedule

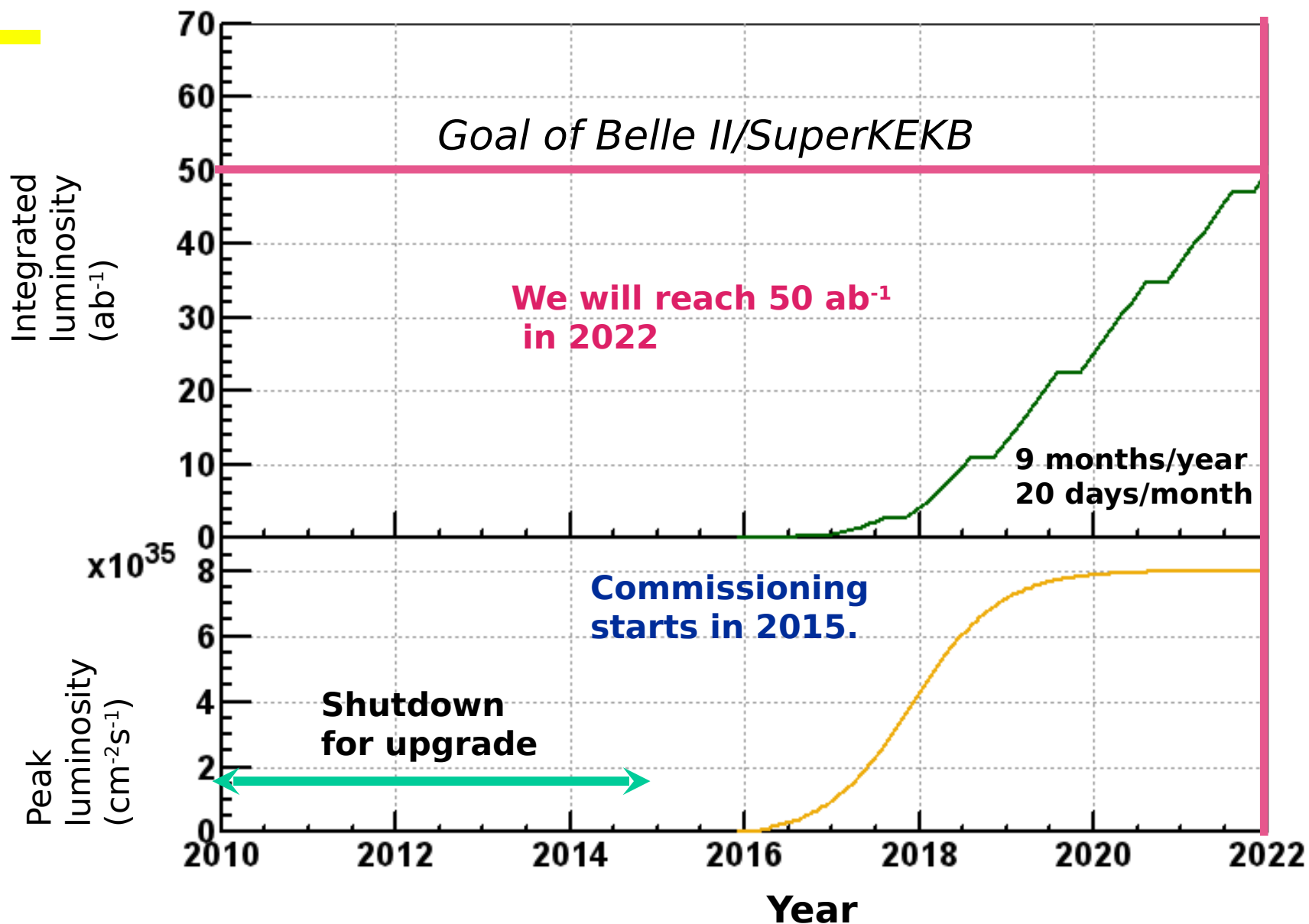

The schedule is likely to shift by a few months because of a new construction/commissioning strategy for the final quads.